

# IZELTAS®

2026 OCAK



 YERLİ ÜRETİM

YENİ TASARIM  
NEW DESIGN

**IZELTAS®**

**BİLDİĞİNİZ  
KALİTE  
DAHA  
ERGONOMİK**



**A - KAPSAM İÇİ**

- İzeltaş markalı ürünlerde üretim yılına bakılmaksızın, normal kullanım şartları içinde, imalat veya malzeme hatası tespit edilen ürünler ömür boyu garanti kapsamında tamir edilir veya mümkün değilse derhal yenisi ile değiştirilir.
- İzeltaş dışındaki markalarımızda tüketici koruma kanununa uygun olarak garanti süresi farklılık göstermektedir.

**B - KAPSAM DIŞI**

Aşağıda yazılı şartlarda kullanılan aletler, garanti kapsamı dışında olup, yenisi ile değiştirilmezler.

- Kullanım amacı veya kullanma talimatı dışında kullanılmış olan ürünler.
- Aşırı zorlama ile, boru takılarak veya çekiçle vurularak darbeli kullanım sonucu deforme olmuş ya da kırılmış olan ürünler.
- Kullanıcı tarafından üzerinde taşlama, zımparalama, delme veya kaynak yapılarak orijinal hali bozulmuş olan ürünler.
- Kullanıldıktan sonra, gerekli koruyucu bakımları yapılmadan, tozlu, rutubetli ve çamurlu ortamlarda bekletilerek fonksiyonu kaybolmuş ürünler.
- Uygun olmayan rutubetli ortamlarda, uzun süre stoklanarak, paslanmış, korozyona uğramış olanlar.
- Uzun süre kullanılmış veya kullanım ömrünü tamamlamış, buna bağlı olarak eskimiş, yıpranmış, deforme olmuş ürünler.

**EMNİYETLİ VE DOĞRU EL ALETİ KULLANIM KURALLARI****A - UYULMASI GEREKEN KURALLAR:**

- Anahtarın ölçüsünün kullandığınız parçaya göre uygun olduğundan emin olunuz.
- Kullanım esnasında aletin doğru şekilde yerleştirildiğinden emin olunuz.
- Aleti sık kontrol ediniz. Aşınmış, zarar görmüş aletleri değiştiriniz.
- Aleti kullanım şartlarına uygun olarak kullanınız, aşırı yük uygulamayınız.
- Özellikle çekiçlerde vurma yüzeyinin, vurulan yüzeyden daha büyük olmak zorunda olduğuna dikkat ediniz.
- Havali aletlerde daima uygun aksesuarı kullanınız. (Ayrıca basınçlı havanın yağlandığından emin olunuz.)
- Çalışma şartlarına göre uygun kişisel koruma teçhizatı kullanınız.
- Tekerlekli takım dolaplarını, daima kapılarını ve hareketli bölümlerini kilitledikten sonra hareket ettiriniz.
- Tekerlekli takım dolabı üzerinde çalışırken, tekerleklerini frenleyiniz.
- Yüksek gerilimli çalışma ortamlarında TS EN IEC 60900 Standartına uygun olarak üretilmiş VDE belgeli ürünleri kullanınız.
- Aletlerin nemli ve ıslak ortamlarda kullanımı ardından mutlaka kurutunuz ve hafif yağlayınız.

**B - YAPILMAMASI GEREKEN İŞLEMLER:**

- Boru vb. uzatmalar kullanarak olması gereken tork gücünü aşmayınız. (Özellikle tüm anahtarlarda)
- Hiçbir aleti üretim maksadına aykırı işlerde kullanmayınız. (örneğin: tornavidanın levye veya keski gibi kullanımı)
- Aşırı güç uygulayarak (boru takarak veya çekiçle vurarak) aleti zorlamayınız. (örneğin: anahtarlar ve tornavidalar)
- Hiçbir zaman, kullandığınız aleti kendinden daha sert olan bir cisme vurmayınız. (örneğin: çekiç ve keski)
- Aletleri değişikliğe uğratmayınız. (Şekli veya bir kısmını)
- Metrik ölçülü anahtarları, inch ölçülü civatalarda kullanmayız veya tersini yapmayınız.
- Yıpranmış ve hatalı aletleri kullanmayınız.
- Tekerlekli tamir dolabı dolu iken, birden fazla çekmeceyi açık tutmayınız, çekmeceler açıkken hareket ettirmeyiniz.
- Aletin fonksiyonunu iyileştirmek maksadı ile üzerinde zımpara, taş, kaynak vb. işlem yapmayınız.
- Aletin kullanımı sırasında boya veya kaplamanın çıkacağı etkilere maruz bırakmayınız. Aksi halde korozyon dayanımı negatif etkilenecektir.
- İzolasyonu zedelenmiş, sapı yıpranmış VDE sertifikalı ürünleri hiçbir şekilde yüksek gerilim ihtiva eden ortamlarda kullanmayınız.
- Kontrol kaleminin iç mekanizmasını kesinlikle sökmeye çalışmayınız. Kontrol kalemleri 110 - 250 VAC çalışma aralığı için uygundur.
- Yukarıda bahsedilen şartlara ve doğru kullanıma riayet ederek, her zaman amaca yönelik uygun aletleri kullanınız.

**A - COVERAGE**

- Regardless of the year of manufacture, products bearing the İzeltaş brand that are found to have manufacturing or material defects under normal conditions of use are covered by a lifetime warranty and will be repaired or if repair is not possible replaced immediately with a new product.
- For brands except İzeltaş, the warranty period varies in accordance with consumer protection laws.

**B - EXCLUSIONS**

Products used under any of the conditions listed below are excluded from the warranty scope and cannot be replaced with new ones:

- Products used outside the intended purpose or instructions of use;
- Products deformed or broken due to excessive forcing, pipe attachment or hammer impact;
- Products whose original form is altered by the user by stoning, grinding, perforation or welding;
- Products which lost their function due to being left in dusty, moist or muddy environments without necessary protective maintenance after use;
- Products which became rusted or corroded due to being stored in unsuitable, moist environments for extended periods of time;
- Products which are used for a long period of time or which have completed their useful life and accordingly have become old, worn out and deformed.

**RULES FOR SAFE AND CORRECT USE OF HAND TOOL****A - PRACTICAL RULES:**

- Make sure size of the wrench is appropriate for the work piece.
- Make sure the tool is positioned correctly during use.
- Frequently control the tool. Replace worn or damaged tools.
- Use the tool in accord with instructions of use. Do not place too much load on the tool.
- Especially beware of the point that the impact surface of a hammer must be larger than the impacted surface.
- Always use appropriate accessories for pneumatic tools. (Also make sure the pneumatic system is properly lubricated.)
- Use personal protection equipment appropriate for work conditions.
- Always make sure to lock lids and moving parts of wheeled set cabinets before moving them.
- Make sure to lock brakes of the wheeled set cabinets before working on them.
- Use VDE certified products made in accord with TS EN IEC 60900 Standard in high voltage work environments.
- Make sure to dry and lightly lubricate tools after use in moist and wet environments.

**B- ACTIONS TO AVOID:**

- In case of use with extensions like pipes, etc. do not exceed the specified torque value (especially in case of all wrenches).
- Do not use any tool outside of its intended purpose (e.g. do not use a screwdriver as a lever or a chisel).
- To not force the tool (e.g. wrenches and screwdrivers) by using excessive force (by pipe attachment or hammer impact).
- Never use the tool to hit another object harder than the tool (e.g. hammer and chisels).
- Do not alter the tools (in form or partially).
- Do not use metric sized wrenches on inch sized bolts or vice-versa.
- Do not use worn out or faulty tools.
- Do not leave multiple drawers open when using the wheeled set cabinet and do not move the cabinet while the drawers are open.
- Do not perform grinding, stoning, welding, etc. on the tool in order to improve its function.
- Do not expose the tool to conditions that might result in loss of paint or coating during use. Otherwise corrosion resistance of the tool will be affected.
- Never use VDE certified products with damaged or worn isolation or handle in high voltage work environments.
- Never attempt to dismantle the internal assembly of the tester. Testers are suitable for use in the 110 - 250 VAC operation range.
- Always use the right tool for the right job and follow the conditions and rules of correct usage detailed above.

## Yarım asırlık 'güven'

### Kalite yolculuğu inanmakla başlar.

Türkiye'nin ilk ve en büyük el aletleri üreticisi İZELTAŞ, 1968 yılında Ege'nin gözbebeği İzmir'den işte bu inançla yola çıktı. Yüzdde 100 Türk sermayesiyle oluşturulan ve günden güne büyüyen İZELTAŞ, modern teknolojiyle donatılmış dev tesislerinde üretilen dört bin beş yüz den fazla ürünle 40 ülkeye ihracat yaparak hem kendi insanına hem de ülke ekonomisine katkı sağlıyor.

El aletlerinin yanı sıra üretilen dövme parçalar ile başta otomotiv olmak üzere inşaat, denizcilik ve madencilik sektörüne, savunma ve havacılık sanayilerine, ziraat endüstrisine, altyapı işlerine dek birçok kamu ve özel sektör kuruluşuna hizmet sunuyor.

### Daha iyisi, daha yenisi için...

Kaliphane, dövme, işleme, ısı işleme, krom-nikel kaplama, boyama, plastik daldırma, plastik enjeksiyon ve markalama departmanlarından oluşan dünyadaki ender entegre fabrikalardan İZELTAŞ'ta üretimin her aşamasında kalite kontrolüne tabi tutulan ürünler; fiziksel, metalürjik, kimyasal ve elektriksel testlerden geçirilerek İZELTAŞ güvencesine alınıyor. Ar-Ge ve inovasyon ışığında değişime ve gelişime her daim açık olan İZELTAŞ, bu sayede gücüne güç katıyor. T.C. Sanayi ve Teknoloji Bakanlığının AR-GE Merkezi belgesine sahip İZELTAŞ, TS EN ISO 9001 Kalite Yönetim Sistemi, ISO/IEC 27001 Bilgi Güvenliği Yönetim Sistemi, TS (OHSAS) 18001 İş Sağlığı ve Güvenliği Yönetim Sistemi, TS EN ISO 14001 Çevre Yönetim Sistemi, TS EN ISO 50001 Enerji Yönetim Sistemleri; TSE, TSEK, VDE GS ürün kalite belgeleri ve yüksek teknolojisi ile sadece Türkiye'de değil, dünyada da farkını ortaya koyuyor.

### Önce güvenlik, sonra üretim

İnsan önemli, emek değerlidir. İZELTAŞ, "Önce güvenlik" anlayışından ayrılmadan, çalışanları için önlem almaya, onları iş sağlığı ve güvenliği konusunda eğitmeye devam ediyor. Çünkü; "İnsan vücudunun yedek parçası yoktur"

### Size ulaştıktan sonra...

Satış sonrasında tüketici haklarını koruma ve sınırsız hizmet anlayışı İZELTAŞ'ın vazgeçilmez şirket politikalarından birini oluşturuyor.

Dolayısıyla...

- El aletleri' dendiğinde akla gelen ilk isim olabildiysek,
- Yarım asırdır 'aileden biri' olmanın hakkını verebildiysek,
- 'Türk malı' sözünün altına imzamız atabildiysek,
- 'Yıllarca kullanılır' diyerek her zaman tercih edildiysek,

Gücümüzü, şevkimizi ve inancımızı siz değerli bayilerimiz ve tüketicilerimizden alıyoruz.

1000+ çalışanımızla birlikte üreterek, değer sağlayarak dünya markası olmanın haklı gururunu yaşıyoruz.

Nice başarılı yıllara!

## Half a century of reliability

### Faith is the essential step on the journey to achieve utmost quality.

As the first and largest hand tool manufacturer of Turkey, İZELTAŞ, had this faith as it started its journey in 1968 in İzmir, the beautiful city in the Aegean region. Its establishment, consisting of 100% national capital, İZELTAŞ has grown in years into an industrial giant with huge facilities equipped with state-of-the-art technologies and over 4500 products. Exporting to more than 40 countries, the company is a prominent contributor to not only the Turkish economy but also the community.

Along with manufacturing hand tools, İZELTAŞ produces forged steel parts for various industries like automotive, construction, maritime, mining, aviation, defence, agriculture and infrastructure.

### Newer and better

İZELTAŞ is one of the few fully integrated factories in the world that consists of die tooling, forging, processing, heat processing, chrome-nickel plating, dyeing, pvc coating, plastic injection and marking departments. Every stage of the production is tested for quality assurance using physical, metallurgical, chemical and electrical methods. R&D and innovation are the key words that empower İZELTAŞ as a company which embraces development and improvement as its main philosophy.

İZELTAŞ is an accredited R&D Center by the Ministry of Science, Industry and Technology and has been certified with the following: ISO 9001 Quality Management System, ISO/IEC 27001 Informationsecurity Maniagement System, OHSAS 18001 Occupational Health and Safety Management System, ISO 14001 Environment Management System, ISO 50001 Energy Management System certification, TSE, TSEK and VDE GS product certification.

### Safety before production

Humans are the most significant factors of any industry and their labour is precious. Health and safety awareness is the fundamental policy of İZELTAŞ. The company continuously organizes training programs on occupational health and safety which emphasise that safety comes first and it is not possible to fix humans by changing the damaged organs with spare ones.

### Customer satisfaction

Another fundamental policy of İZELTAŞ is the customer satisfaction. The company is dedicated to serve its customers and protect their rights as consumers.



















Hence...

- We are the first brand that comes to mind in the hand tools industry
- We are valued almost as a part of the families of our consumer
- We have proved ourselves worthy of the statement "Made in Turkey"
- We have been the first choice of the consumers for durability over the years

Our power, enthusiasm and faith are derived from our distinguished dealers and consumers.

We are proud to have become a world brand with our 1000+ employees who strive everyday to contribute to the productivity of the company, creating an added value for the economy and our community.

To many successful years to come!

Takım Dolapları ve Takım Çantaları / Tool Trolleys, Tool Boxes		5-63
Anahtarlar / Wrenches		64-84
Lokma ve Bijon Anahtarları / Sockets and Rim Wrenches		85-112
Havalı Lokma Anahtarlar / Impact Socket Wrenches		113-121
Boru Anahtarları ve Penseler / Pipe Wrenches and Pliers		123-140
1000V Grubu Ürünler / 1000V Product Group		141-153
Tornavida ve Allen Anahtarlar / Screwdrivers and Hex Key Wrenches		155-176
Bits Uçlar / Bits		177-184
Keskiler ve Çekiçler / Chisels and Hammers		185-191
Genel El Aletleri / General Hand Tools		193-208
Aydınlatma / Lighting		209-213
Maket Bıçakları / Utility Knives		215-218
Makaslar / Shears		219-226
Çektirmeler / Pullers		227-233
Elta Ürünleri / Elta Products		235-254
Yedek Parçalar / Spare Parts		255-259
Ticari Teşhir Standları / Commercial Display Panels		261-275
Teknik Bilgiler / Technical Information		



*"Sadece el aleti üretmiyoruz;  
el aletleriyle her şeyi üretiyoruz."*

*"We don't just produce hand tools;  
we build everything with hand tools."*

# TAKIM DOLAPLARI, TAKIM ÇANTALARI VE ALET SETLERİ

TOOL TROLLEYS, TOOL BOXES AND HAND TOOL SETS

- Takım Dolapları  
Workshop Trolleys
- Soyunma Dolapları  
Lockers
- Taşıma Arabaları  
Service Trolleys
- Servis Masaları  
Workbenches
- Takım Çantaları  
Tool Boxes
- Alet Setleri  
Tool Sets
- Bez Takım Çantaları  
Tool Bags

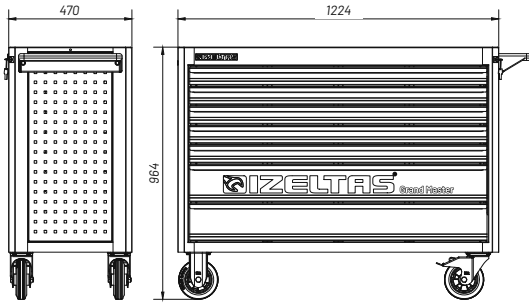

**Grand Master Seri Takım Dolabı (7 Çekmeceli)**  
**Grand Master Series Workshop Trolley (7 Drawers)**

Ölçü/Size: 470x1224x964 mm

- ✓ Ergonomik sap
- Ergonomic handle



- ✓ 2 sabit, 2 hareketli frenli tekerlek ø 150mm
- 2 swivel castors with brake
- 2 fixed castors ø 150mm



- ✓ Yüksek dayanımlı elektrostatik toz boya
- High strength electrostatic powder coating.



- ✓ 18mm masif üst tabla
- 18 mm solid wood top

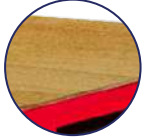



- ✓ %100 açılabilir teleskobik raylar
- ✓ Devrilme emniyet sistemi
- %100 extendable telescopic slides
- Anti tilt system



- ✓ Merkezi kilit
- ✓ Mandal sistemi
- Central lock
- Handgrip Lock system



Sacdan imal edilmiş, yüksek dayanımlı elektrostatik gofrato toz boya  
 Made from metal sheet, durable electrostatic embossed powder coating

KOD/CODE	ÇEKMECE DRAWERS			 Kg	RENK COLORS	TL/Ad
		1098x400x60	1098x400x135			
8246 32 1007	7	5X	2X	114.9		54.426,50
13000 005434 Dolu/Full 251 Parça/Pcs	7	5X	2X	134.2	<div style="background-color: black; color: white; padding: 2px;">RAL 9005 GOF</div> <div style="background-color: red; color: white; padding: 2px;">RAL 3020 GOF</div>	200.938,50

**1. Grand Master Seri Çekmece/Drawer**

**Sol Taraf / Left Side Kod / Code 13000 005590**

KOD CODE	İÇERİK CONTENTS	☐	TL/Ad
0330	<b>Kombine Anahtar Uzun Boy</b> Combination Wrench Long Pattern 6 - 7 - 8 - 9 - 10 - 11 - 12 - 13 - 14 - 15 - 16 - 17 - 18 - 19 - 20 - 21 - 22 - 23 - 24 - 25 - 26 - 27 - 28 mm	23	8.398,25

**Sağ Taraf / Right Side Kod / Code 13000 005589**

KOD CODE	İÇERİK CONTENTS	☐	TL/Ad
0330	<b>Kombine Anahtar Uzun Boy</b> Combination Wrench Long Pattern 29 - 30 - 32 - 34 - 36 - 41 mm	6	5.227,25

**2. Grand Master Seri Çekmece/Drawer**

**Sol Taraf / Left Side Kod / Code 13000 005591**

KOD CODE	İÇERİK CONTENTS	☐	TL/Ad
0130	<b>İki Ağız Anahtar Uzun Boy</b> Double Ended Open Jaw Wrench Long Pattern 6x7 - 8x9 - 10x11 - 12x13 - 14x15 - 16x17 - 18x19 - 20x22 - 21x23 - 24x26 - 25x28 - 27x32 - 36x41 mm	13	4.136,00

**Sağ Taraf / Right Side Kod / Code 13000 005592**

KOD CODE	İÇERİK CONTENTS	☐	TL/Ad
0430	<b>Yıldız İki Ağız Anahtar</b> Double Ended Ring Wrench 6x7 - 8x9 - 10x11 - 12x13 - 14x15 - 16x17 - 18x19 - 20x22 - 21x23 - 24x26 - 25x28 - 27x32 - 36x41 mm	13	6.841,75

### 3. Grand Master Seri Çekmece/Drawer



#### Sol Taraf / Left Side Kod / Code 13000 005594

KOD CODE	İÇERİK CONTENTS	☐	TL/Ad
3301	Dış Segman Pense Yaylı Düz Circlip Pliers, External (Flat) 170 - 302 mm	2	
3311	Dış Segman Pense Yaylı Eğri Circlip Pliers, External (Bent) 160 - 289 mm	2	11.514,75
3321	İç Segman Pense Yaysız Düz Circlip Pliers, Internal (Flat) 179 - 305 mm	2	
3331	İç Segman Pense Yaysız Eğri Circlip Pliers, Internal (Bent) 169 - 291 mm	2	

#### Sağ Taraf / Right Side Kod / Code 13000 005593

KOD CODE	İÇERİK CONTENTS	☐	TL/Ad
0600	Kurbağacak Anahtar 12" Adjustable Wrench	1	
2400	Üniversal Fort Pense 240 mm Waterpump Pliers Universal	1	
2500	Üniversal Ayarlı Pense 250 mm Universal Grip	1	
3020	Kombine Pense Opak Seri 180 mm Combination Pliers	1	
3220	Kargaburun Düz Uçlu Opak 180 mm Long Nose Pliers	1	16.703,25
3700	Yan Keski Opak Seri 160 mm Side Cutting Pliers	1	
3425	Hortum Kelepçe Pense Sıkıştırma Tipi 235 mm / Hose Clamp Pliers	1	
07415	6 Sıralı Tel Fırça Ağaç Saplı Hand Brush (Wooden Handle)	1	
6380	Çift Zincirli Yağ Filtresi Sökeceği 60x160 mm Oil Filter Wrench With Double Chain	1	
6820	Tenekeci Makası 250 mm Yaylı Tinman's Snip	1	



## 4. Grand Master Seri Çekmece/Drawer



## Sol Taraf / Left Side

Kod / Code 13000 005595

KOD CODE	İÇERİK CONTENTS	☐	TL/Ad
4903	<b>Allen Anahtar Takımı Altı Köşe Uzun Boy 12 Parça</b> Hex Key Wrench Set Long Pattern 2 - 2,5 - 3 - 3,5 - 4 - 5 - 6 - 7 - 8 - 9 - 10 - 12	12	
4903	<b>Allen Anahtar Altı Köşe Uzun Boy</b> Hex Key Wrench Long Pattern 14 - 16 - 17 - 19 mm	4	9.005,25
4920	<b>T Tipi Allen Anahtar Takımı 8 Parça</b> Hex Key Wrench T Handle Set 2,5 - 3 - 4 - 5 - 6 - 7 - 8 - 10	8	

## Sağ Taraf / Right Side

Kod / Code 13000 005596

KOD CODE	İÇERİK CONTENTS	☐	TL/Ad
4300	<b>Opak Seri Düz Uçlu Tornavida</b> Screwdriver, Opak, Flat 3x80 - 4x80 - 4x100 - 5x125 - 6x150 mm	5	
4320	<b>Opak Seri Yıldız Uçlu Tornavida</b> Screwdriver, Opak, Phillips 4,5x80 - 6x100 mm	2	
4770	<b>Lokma Uçlu Tornavida</b> Nut Spinner 6 - 7 - 8 - 9 - 10 - 11 - 12 - 13 mm	8	8.252,50
4788	<b>Manyetik Bits Tutucu Tornavida</b> Flexiblee 6.3x175 Screwdriver, Magnetic Bit Holder (Long)	1	
4800	<b>31'li Bits Takım (Plastik Kutulu)</b> Bit Set in Plastic Case	31	
6220	<b>Spiralli Mıknatıs 1000 gr</b> Flexible Magnet Holder	1	



## 5. Grand Master Seri Çekmece/Drawer



Sol Taraf / Left Side

Kod / Code 13000 005598

Sağ Taraf / Right Side

Kod / Code 13000 005597

KOD CODE	İÇERİK CONTENTS	☐	TL/Ad
0340	<b>Cırcır Kombine Anahtar</b> Combination Wrench With Ratchet 10 - 13 - 17 - 19 mm	4	
1113	<b>1/2" Altı Köşe Lokma Anahtar</b> Socket Wrench 6 Points 10 - 11 - 12 - 13 - 14 - 15 - 16 - 17 - 18 - 19 - 21 - 22 - 23 - 24 26 - 27 - 28 - 30 - 32 mm	19	
1113	<b>1/2" Lokmalı Allen Uç</b> Hexagonal Bit Socket Wrench 5 - 6 - 7 - 8 - 10 - 12 - 14 mm	7	
1113	<b>1/2" Lokmalı Star (Torx®) Uç</b> Star Torx® Bit Socket Wrench T25 - T27 - T30 - T40 - T45 - T50 - T55 - T60	8	16.371,75
1513	<b>1/2" Cırcır Kolu 250 mm (32 Diş)</b> Ratchet Handle	1	
1513	<b>1/2" Ara Kol / Extension Bar</b> 125 - 250 mm	2	
1513	<b>1/2" T Kol 250 mm / Sliding T Handle</b>	1	
1513	<b>1/2" Mafsal 70 mm / Universal Joint</b>	1	
1513	<b>1/2" F x 3/4" M Lokma Adaptörü / Adapter</b>	1	
1519	<b>3/4" F x 1/2" M Lokma Adaptörü / Adapter</b>	1	

KOD CODE	İÇERİK CONTENTS	☐	TL/Ad
1113	<b>1/2" Altı Köşe Havalı Derin Lokma Anahtar</b> Impact Socket Wrench 6 Points 10 - 11 - 12 - 13 - 14 - 15 - 16 - 17 - 18 - 19 - 21 - 22 - 24 - 27 - 30 - 32 mm	16	
1513	<b>1/2" Fx3/4" M Havalı Lokma Adaptörü</b> Impact Socket Adapter	1	
1513	<b>1/2" Havalı Lokma Ara Kol 125 mm</b> Impact Socket Extension Bar	1	
1513	<b>1/2" Havalı Lokma Mafsal 75 mm</b> Impact Socket Universal Joint	1	
1119	<b>3/4" Altı Köşe Havalı Lokma Anahtar</b> Impact Socket Wrench 6 Points 19 - 21 - 22 - 24 - 27 - 30 - 32 - 34 - 36 - 41 - 46 mm	11	27.262,75
1519	<b>3/4" Havalı Lokma Ara Kol 250 mm</b> Impact Socket Extension Bar	1	
1519	<b>3/4" Havalı Lokma Mafsal 108 mm</b> Impact Socket Universal Joint	1	
1519	<b>3/4" F x 1/2" M Havalı Lokma Adaptörü</b> Impact Socket Adapter	1	



## 6. Grand Master Seri Çekmece/Drawer



Sol Taraf / Left Side

Kod / Code 13000 005600

Sağ Taraf / Right Side

Kod / Code 13000 005599

KOD CODE	İÇERİK CONTENTS	☐	TL/Ad
5010	Iskarpela Düz 22 mm Wood Chisel	1	
5800	Tesviyeci Çekiç Machinist Hammer 2000 - 500 gr	2	
5850	Plastik Çekiç 40 mm Plastic Hammer	1	
05881	Plastik Şerit Metre 5 m Plastic Steel Case Measuring Tapes	1	9.324,50
14000 005358	Topuklu Keçe Levyesi 400 mm Prybar	1	
5500	Düz Keski 250 mm Flat Cold Chisel	1	
	Antifriz Bomesi Antifreeze Tester	1	

KOD CODE	İÇERİK CONTENTS	☐	TL/Ad
1119	3/4" Altı Köşe Lokma Anahtar Socket Wrench 6 Points 22 - 24 - 27 - 30 - 32 - 34 - 36 - 41 - 46 - 50 - 55 - 60 mm	12	
1519	3/4" Cırcır Kolu 510 mm Ratchet Handle	1	20.649,75
1519	3/4" Ara Kol Extension Bar 200 - 400 mm	2	
1519	3/4" T Kol 500 mm Sliding T Handle	1	

## 7. Grand Master Seri Çekmece/Drawer

Gres Pompası / Grease Gun



Gres Pompası Hortumu / Hose for Grease Gun



Levye Oluklu Kıvrık Uçlu / Tyre Lever, Bent



KOD CODE	İÇERİK CONTENTS	☐	TL/Ad
6230	Gres Pompası (500 cc) Grease Gun	1	1.480,50
6230	Gres Pompası Hortumu Hose for Grease Gun	1	288,75
6360	Levye Oluklu Kıvrık Uçlu 600 mm Tyre Lever, Bent	1	1.055,00



**Premium Serisi Takım Dolabı (5-7 Çekmeceli)**  
Premium Series Workshop Trolley (5-7 Drawers)



✓ 7 bölmeli sağlam ve dayanıklı ABS plastik üst malzeme tabla.  
● Resistant and solid top cover having 6 divisions



✓ %100 açılabilir teleskobik raylar  
✓ Devrilme emniyet sistemi  
● %100 extendable telescopic slides  
● Anti tilt system



✓ Merkezi kilit  
✓ Mandal sistemi  
● Central lock  
● Handgrip Lock system



✓ 2 sabit, 2 hareketli frenli tekerlek ø 125mm  
● 2 swivel castors with brake  
2 fixed castors ø 125mm



✓ Standard tutma sapı  
● Standard handle



✓ Plastik köşe koruma  
● Plastic corner protection



✓ Yüksek dayanımlı elektrostatik toz boya  
● High strength electrostatic powder coating



✓ Havluluk x1  
Avedanlık x2 Askılık x1  
● Paper Roll Holder  
x1 Bottle & Tins Holder  
x2 Hanger x1



İZELTAS YOUTUBE

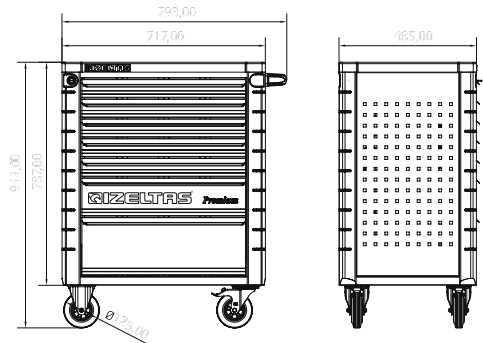

Ölçü/Size: 485x717x944 mm

RAL 9005 GOF

RAL 3020 GOF

Sacdan imal edilmiş, yüksek dayanımlı elektrostatik gofrato toz boya  
Made from metal sheet, durable electrostatic embossed powder coating

KOD/CODE	ÇEKMECE DRAWERS	30 kg	30 kg	30 kg	Kg	TL/Ad
8245 32 1005	5	400x548x63	400x548x132	400x548x202	64.2	35.312,00
8245 32 1007	7	5X	1X	1X	70.4	45.713,25
8245 00 7096 Dolu/Full 250 Parça/Pcs	7	5X	1X	1X		113.348,50



## 1. Premium Seri Çekmece/Drawer

Kod / Code 8245 00 1042

KOD CODE	İÇERİK CONTENTS	☐	TL/Ad
0100	<b>İki Ağız Anahtar Kısa Boy</b> D/E Open Jaw Wrenches Short Pattern 6x7-8x9-10x11-12x13-14x15-16x17-18x19-20x22	8	
0320	<b>Kombine Anahtar Kısa Boy</b> Combination wrenches Short Pattern 6-7-8-9-10-11-12-13-14-15-16-17-18-19-20-21-22-24-27-30-32	21	15.075,50
0430	<b>Yıldız Anahtar</b> Ring Wrenches 6x7-8x9-10x11-12x13-14x15-16x17-18x19-20x22	8	
0340	<b>Cırcır Kombine Anahtar / Combination Wrench With Ratchet</b> 8-10-13-17-19	5	

## 2. Premium Seri Çekmece/Drawer

Kod / Code 8245 00 2094

KOD CODE	İÇERİK CONTENTS	☐	TL/Ad
1107	<b>1/4" Lokmalı Allen Uçlar / Hexagonal Bits Socket</b> 2,5-3-4-5-6-7-8-10	8	
1107	<b>1/4" Lokmalı Torx® Uç / Torx® Bits Socket</b> T8-T9-T10-T15-T20-T25-T27-T30-T40	9	
1107	<b>1/4" Lokmalı Yıldız Uç / Phillips Bits Socket</b> PH1-PH2-PH3	3	
1107	<b>1/4" Lokmalı Düz Uç / Slotted Bits Socket</b> 3-4-5,5-6,5	4	
1107	<b>1/4" Altı Köşe Derin Lokma / Deep Socket Wrench 6 Point</b> 4-5-5,5-6-7-8-9-10-11-12-13	11	
1113	<b>1/2" Lokmalı Allen Uç / Hexagonal Bits Socket</b> 5-6-7-8-10-12-14	7	
1113	<b>1/2" Lokmalı Torx® Uç / Torx® Bits Socket</b> T20-T25-T27-T30-T40-T45-T50-T55-T60	9	
1107	<b>1/4" Altı Köşe Lokma Takımı / Socket Wrench Set</b> <b>1/4" Cırcır kolu / Ratchet Handle</b> <b>1/4" Mafsal / Universal Joint</b> <b>1/4" T Kol / Sliding T Handle</b>	15	16.782,25
1113	<b>1/4" Ara Kol / Extension Bar 50-100 mm</b> <b>1/2" Buji Lokma Lastikli</b> Spark Plug Socket With Rubber 16 mm	1	
1113	<b>1/2" Lokma Takımı / Socket Wrench Set</b> <b>1/2" Cırcır Kolu 32 Diş / Ratchet Handle</b> <b>1/2" Mafsal / Universal Joint</b> <b>1/2" T Kol Adaptör / Sliding T Handle Adapter</b> <b>1/2" Ara Kol / Extension Bar 125-250 mm</b>	24	

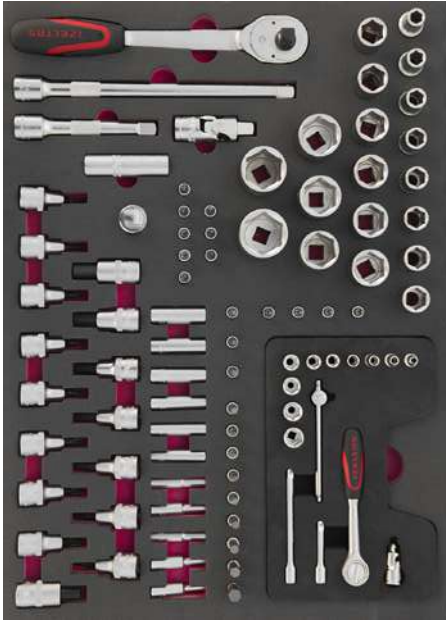

## 3. Premium Seri Çekmece/Drawer

Kod / Code 8245 00 3014

KOD CODE	İÇERİK CONTENTS	☐	TL/Ad
3700	<b>Yan Keski Opak Seri / Side Cutting Pliers 160 mm</b>	1	
3020	<b>Kombine Pense Opak Seri / Combination Pliers 180 mm</b>	1	
3220	<b>Kargaburun Düz Uçlu Opak Seri / Long Nose Pliers Flat 180 mm</b>	1	
4300	<b>Opak Seri Düz Uçlu Tornavida / Screwdriver, Flat</b> 3x80-5x125-7x150	3	7.784,00
4320	<b>Opak Seri Yıldız Uçlu Tornavida / Screwdriver, Phillips</b> 3x60-4,5x80-6x100-8x150	4	
3301	<b>Dış Segman Pensi Düz / Circlip Pliers, External Flat</b> 134-170mm	2	
3321	<b>İç Segman Pensi Düz / Circlip Pliers, Internal Flat</b> 145-179mm	2	

**4. Premium Seri Çekmece/Drawer** Kod / Code 8245 00 4043

KOD CODE	İÇERİK CONTENTS	☐	TL/Ad
4770	Lokma Uçlu Tornavida / Nutspinner 6-7-8-9-10-13	6	
4910	Torx® Allen Takım / Torx® Key Wrench Set T9-T10-T15-T20-T25-T27-T30-T40	8	
4900	Allen Takımı 6 Köşe / Hex Key Wrench Set 2-2.5-3-3.5-4-5-6-7-8-9-10-12	12	8.919,50
4906	Yuvarlak Başlı Uzun Allen Takımı / Hex key Wrench Ballpoint Long Pattern Set 1.5-2-2.5-3-4-5-6-8-10	9	
4920	T Tipi Allen Anahtar / T Type Hex Key Wrench 2.5-3-4-5-6-7-8-10	8	

**5. Premium Seri Çekmece/Drawer** Kod / Code 8245 00 5043

KOD CODE	İÇERİK CONTENTS	☐	TL/Ad.
4565	Oto Elektrik Kontrol Kalemi / Car Voltage Tester 135mm	1	
07415	Sıralı Tel Fırça 4 Sıralı / Hand Brush 4 Raws	1	
2400	Üniversal Fort Pense / Waterpump Pliers Universal 240 mm	1	
2500	Üniversal Ayarlı Pense / Universal Grip 250 mm	1	
0600	Kurbağacık Anahtar / Adjustable Wrench 10"	1	
4780	Manyetik Bits Tutucu Tornavida / Screwdriver, Magnetic Bit Holder 6.3x120	1	
4800	31'li Bits Set (Plastik Kutulu) / Bits Set in Plastic Case	31	9.696,75
4110	Düz Topaç Tornavida / Screwdriver, Stubby, Flat 6.5x25	1	
4130	Yıldız Topaç Tornavida / Screwdriver, Stubby, Phillips 6x25	1	
5500	Düz Keski Krom / Flat Cold Chisel 150 mm	1	
5800	Tesviyeci Çekici / Machinist's Hammer 300-1500 gr	2	
6350	Levye Oluklu / Tyre Lever 500 mm	1	

**6. Premium Seri Çekmece/Drawer** Kod / Code 8245 00 6009

KOD CODE	İÇERİK CONTENTS	☐	TL/Ad
1840	1/2" Mafsallı T Kol Swivel Handle With Sliding T 1/2"	1	
6230	Gres Pompası Grease Gun 500cc	1	
06375	Ayarlı Yağ Filtre Sökeceği Adjustable Slot Type Oil Filter Wrench	1	9.377,25
6225	Madeni Yağdanlık (Flexible Uçlu) Oiler With Flexible Spout 200cc	1	
1113	1/2" Altı Köşe Havalı Lokma Anahtar (mm) Impact Socket Wrench 6 Points (mm) 10-13-17-19-21-24	6	
1108	1/2" Altı Köşe Havalı Derin Lokma Anahtar 6 Point Impact Socket Wrench, Long Type (mm) 10-13-17-19-21-24	6	

### Pro Seri 3 Çekmeceli Dolap Üstü Dolap

#### Pro Series Workshop Trolley Top Unit With 3 Drawers



- ✓ %100 açılabilir teleskobik raylar
- ✓ Devrilme emniyet sistemi
- %100 extendable telescopic slides
- Anti tilt system



- ✓ Merkezi kilit
- ✓ Mandal sistemi
- Central lock
- Handgrip Lock system



- ✓ Toplam 2 Adet yan ve arka avadanlık bölümleri
- 2 tool holders



- ✓ 9 bölmeli sağlam ve dayanıklı ABS plastik üst malzeme tabla
- 9 durable ABS worktop with divisions



- ✓ Yüksek dayanımlı elektrostatik toz boya
- High strength electrostatic powder coating

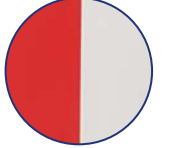

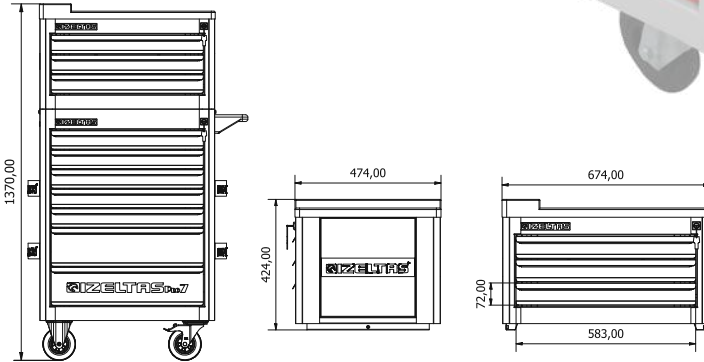
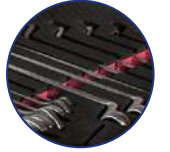

- ✓ 10 Adet Çekmece Seperatörü
- 10 Drawer Separators



Ölçü/Size: 474x674x424 mm

Sacdan imal edilmiş, yüksek dayanımlı elektrostatik gofrato toz boya  
Made from metal sheet, durable electrostatic embossed powder coating

KOD/CODE	ÇEKMECE DRAWERS	 30 kg	 Kg	RENK COLORS	TL/Ad
13000 005279	3	400x548x68	33.2	RAL 7035 GOF RAL 3020 GOF	20.307,00

## 8241 PRO SERİSİ / PRO SERIES

### Pro Serisi Takım Dolabı (5-6-7-8 Çekmeceli) Pro Series Workshop Trolley (5-6-7-8 Drawers)



- ✓ %100 açılabilir teleskobik raylar
- ✓ Devrilme emniyet sistemi
- %100 extendable telescopic slides
- Anti tilt system



- ✓ Merkezi kilit
- ✓ Mandal sistemi
- Central lock
- Handgrip Lock system



- ✓ 9 bölmeli sağlam ve dayanıklı ABS plastik üst malzeme tabla
- 9 durable ABS worktop with divisions



- ✓ 2 sabit, 2 hareketli frenli tekerlek Ø 125mm
- 2 swivel castors with brake, 2 fixed castors Ø 125mm



- ✓ Yüksek dayanımlı elektrostatik toz boya
- High strength electrostatic powder coating

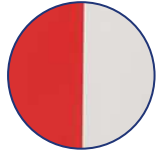

- ✓ Toplam 6 Adet yan ve arka avadanlık bölümleri
- 6 tool holders

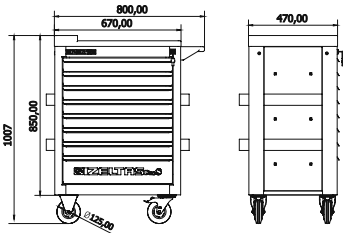

Ölçü/Size: 470x670x1007 mm

Sacdan imal edilmiş, yüksek dayanımlı elektrostatik gofrato toz boya  
Made from metal sheet, durable electrostatic embossed powder coating



RAL 7035 GOF  
RAL 3020 GOF

RAL 7035 GOF  
RAL 5003

RAL 7035 GOF  
RAL 7016

KOD/CODE	CEKMECE DRAWERS					RENK COLORS	TL/Ad
		400x548x68	400x548x143	400x548x218			
8241 32 1005	5	1X	4X	--	63		36.510,50
8241 32 1006	6	4X	1X	1X	65.8	RAL 7035 GOF	39.452,75
8241 32 1007	7	5X	2X	--	69.3	RAL 3020 GOF	46.623,25
8241 32 1008	8	7X	1X	--	70		49.698,50
8241 32 2005	5	1X	4X	--	63		36.510,50
8241 32 2006	6	4X	1X	1X	65.8	RAL 7035 GOF	39.452,75
8241 32 2007	7	5X	2X	--	69.3	RAL 5003	46.623,25
8241 32 2008	8	7X	1X	--	70		49.698,50
8241 32 3005	5	1X	4X	--	63		36.510,50
8241 32 3006	6	4X	1X	1X	65.8	RAL 7035 GOF	39.452,75
8241 32 3007	7	5X	2X	--	69.3	RAL 7016	46.623,25
8241 32 3008	8	7X	1X	--	70		49.698,50
8241 00 1209 Dolu/Full 206 Parça/Pcs	8	7X	1X	--	92.8		108.448,75

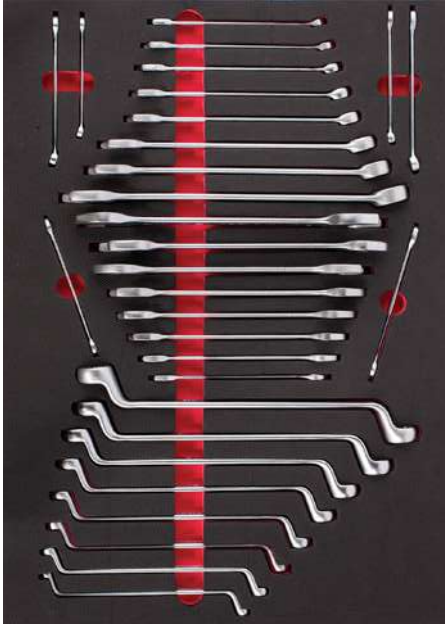

1. Pro Seri Çekmece/Drawer		Kod / Code 8241 00 1030	
KOD CODE	İÇERİK CONTENTS	☐	TL/Ad
0130	<b>İki Ağız Anahtar Uzun Boy / D/E Open Jaw Wrench Long Pattern</b> 6x7 - 8x9 - 10x11 - 12x13 14x15 - 16x17 - 18x19 - 20x22 21x23 - 24x26	10	
0330	<b>Kombine Anahtar Uzun Boy / Combination Wrench Long Pattern</b> 6 - 7 - 8 - 9 - 10 - 11 - 12 - 13 14 - 17 - 19 - 22	12	7.611,50
0430	<b>Yıldız Anahtar / D/E Ring Wrench</b> 6x7 - 8x9 - 10x11 - 12x13 14x15 - 16x17 18x19 - 20x22	8	



2. Pro Seri Çekmece/Drawer		Kod / Code 8241 00 2072	
KOD CODE	İÇERİK CONTENTS	☐	TL/Ad
1107	<b>1/4" Altı Köşe Lokma Takımı / 1/4" Socket Wrench Set</b> 4 - 5 - 6 7 - 8 - 9 - 10 11 - 12 - 13 <b>Altı Köşe</b> Six Point	15	
	<b>1/4" Cırcır kolu / 1/4" Ratchet Handle</b>		
	<b>1/4" Mafsal / 1/4" Universal Joint</b>		
	<b>1/4" T Kol / 1/4" Sliding T Handle</b>		
	<b>1/4" Ara Kol / 1/4" Extension Bar 50-100 mm</b>		
1113	<b>1/2" Lokma Takımı / 1/2" Socket Wrench Set</b> 10 - 11 - 12 13 - 14 - 15 16 - 17 - 18 19 - 21 - 22 23 - 24 - 26 27 - 28 - 30 32	24	15.178,75
	<b>1/2" Cırcır Kolu 32 Diş / 1/2" Ratchet Handle</b>		
	<b>1/2" Mafsal / 1/2" Universal Joint</b>		
	<b>1/2" T Kol Adaptör / 1/2" Sliding T Handle Adapter</b>		
	<b>1/2" Ara Kol / 1/2" Extension Bar 125-250 mm</b>		
1113	<b>1/2" Lokmalı Allen Uçlar / 1/2" Hexagonal Bits Sockets</b> H5-H6-H7-H8-H10-H12-H14	7	
1113	<b>1/2" Lokmalı Star Uç / 1/2" Star Bits Socket</b> T20-T25-T27-T30-T40-T45-T50-T55-T60	9	
0330	<b>Kombine Anahtar Uzun Boy / Combination Wrench Long 16-18</b>	2	
4900	<b>Allen Takımı 6 Köşe / Hex Key Wrench Set 2-2,5-3-3,5-4-5-6-7-8-9-10-12</b>	12	



3. Pro Seri Çekmece/Drawer		Kod / Code 8241 00 3051	
KOD CODE	İÇERİK CONTENTS	☐	TL/Ad
07415	<b>Sıralı Tel Fırça 3 Sıralı / Hand Brush 3 Rows</b>	1	
6350	<b>Levye Oluklu / Tyre Lever 400 mm</b>	1	
6220	<b>Spiralli Miknatis / Flexible Magnet Holder 500 gr</b>	1	
4110	<b>Düz Topaç Tornavida / Screwdriver , Stubby, Flat 6.5x25</b>	1	
4130	<b>Yıldız Topaç Tornavida / Screwdriver , Stubby, Phillips 6x25</b>	1	7.221,00
4770	<b>Lokma Uçlu Tornavida / Nutspinner 6-7-8-9-10-13</b>	6	
4780	<b>Manyetik Bits Tutucu Tornavida / Screwdriver, Magnetic Bit Holder 6.3x120</b>	1	
4905	<b>Yuvarlak Başlı Allen Takımı / Hexkey Wrench Ballpoint Set</b> 2-2,5-3-4-5-6-8-10	8	
4800	<b>Bits Set Takım (Plastik Kutulu) / Bits Set in Plastic Case</b>	31	

**4. Pro Seri Çekmece/Drawer** Kod / Code 8241 00 4027

KOD CODE	İÇERİK CONTENTS	☐	TL/Ad
0340	Cırcır Kombine Anahtar / Combination Wrench With Ratchet 10-13-17-19	4	12.501,25
4909	T Tipi Torx® Allen Anahtar / T Handle Torx® Key Wrench T9-T10-T15-T20-T25-T27-T30-T40	8	
1108	1/2" Altı Köşe Derin Lokma / 1/2" Deep Socket Wrench, Six Points 10-11-12-13-14-15-16-17-18-19	10	
1113	1/2" Altı Köşe Havalı Lokma / 1/2" Impact Socket Wrench 13-17-18-19-24	5	

**5. Pro Seri Çekmece/Drawer** Kod / Code 8241 00 5010

KOD CODE	İÇERİK CONTENTS	☐	TL/Ad
3331	İç Eğri Segman Pense / Circlip Pliers, Internal, Bent 169 mm	1	10.339,25
3321	İç Düz Segman Pense / Circlip Pliers, Internal, Flat 179 mm	1	
3311	Dış Eğri Segman Pense / Circlip Pliers, External, Bent 160 mm	1	
3301	Dış Düz Segman Pense / Circlip Pliers, External, Flat 170 mm	1	
3700	Yan Keski Opak İzole / Side Cutting Pliers, 160 mm	1	
3220	Düz Kargaburun Opak İzole / Long Nose Pliers, 200 mm	1	
3020	Kombine Pense Opak İzole / Combination Pliers, 180 mm	1	
2510	Ayarlı Pense / Special Grip 250 mm	1	
0600	Kurbağacık Anahtar / Adjustable Jaw Wrench 10"	1	
2400	Üniversal Fort Pense / Waterpump Pliers Universal 240 mm	1	

**6. Pro Seri Çekmece/Drawer** Kod / Code 8241 00 6018

KOD CODE	İÇERİK CONTENTS	☐	TL/Ad
4300	Opak Seri Düz Uçlu Tornavida / Opak Screwdriver, Flat 4x100-5x125-6x150-8x175	4	5.898,50
4320	Opak Seri Yıldız Uçlu Tornavida / Opak Screwdriver, Phillips 4.5x80-6x100	2	
5800	Tesviyeci Çekiç / Mechanist Hammer 300 gr	1	
5850	Plastik Çekiç / Plastic Hammer ø30	1	
5545	Konik Pim Zimba / Drift Punch 5 mm	1	
5550	Düz Pim Zimba / Split Pin Punch 5 mm	1	
5540	Nokta Zimba / Center Punch 5x120	1	
5500	Düz Keski / Flat Cold Chisel 150 mm	1	
4920	T Tipi Allen Anahtar / T Type Hex Key Wrench 3-4-5-6-7-8	6	

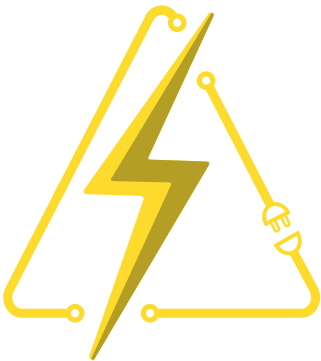

**ELEKTRO**

## ELEKTRO SERİSİ / ELECTRO SERIES

### Elektro Serisi Takım Dolabı (7 Çekmeceli) Electro Series Workshop Trolley (7 Drawers)



✓ 7 bölmeli sağlam ve dayanıklı  
ABS plastik üst malzeme tabla  
● Resistant and solid top  
cover having 7 divisions

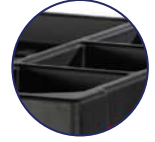

✓ %100 açılabilir teleskobik raylar  
✓ Devrilme emniyet sistemi  
● %100 extendable telescopic slides  
● Anti tilt system



✓ Merkezi kilit  
✓ Mandal sistemi  
● Central lock  
● Handgrip Lock system



✓ 2 sabit, 2 hareketli  
frenli tekerlek ø 125mm  
● 2 swivel castors with brake  
2 fixed castors ø 125mm



✓ Standard tutma sapı  
● Standard handle



✓ Plastik köşe koruma  
● Plastic corner  
protection



✓ Yüksek dayanımlı  
elektrostatik gofrato toz boya  
● High strength electrostatic  
gofrato powder coating

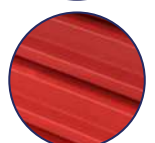

✓ Havluluk x1  
Avadanlık x2 Askılık x1  
● Paper Roll Holder  
x1 Bottle & Tins  
Holder x2 Hanger x1



✓ Magnet Uyarı Etiketi  
● Magnet Warning Sticker



✓ Delikli Sac Pano ve  
20 Adet Askı Teli  
● Perforated Panel for  
Hand Tools

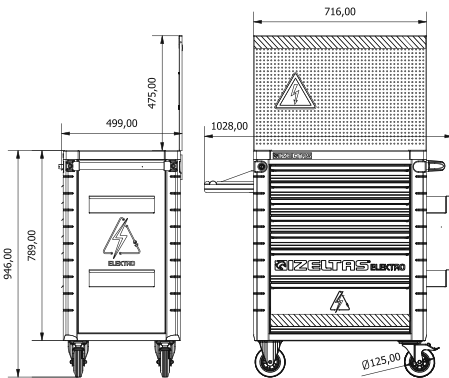
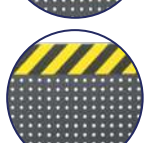

Ölçü/Size: 500x715x945 mm

Sacdan imal edilmiş, yüksek dayanımlı elektrostatik gofrato toz boya  
Made from metal sheet, durable electrostatic embossed powder coating

RAL 9005 GOF

RAL 3020 GOF

RAL 1018

KOD/CODE	ÇEKMECE DRAWERS	30 kg	30 kg	30 kg	Kg	TL/Ad
13000 005547	7	400x548x63	400x548x132	400x548x202	76.8	48.823,50
13000 005548 Dolu/Full 93 Parça/Pcs	7	5X	1X	1X	85.6	104.777,75



## 1. Elektro Seri Çekmece/Drawer

Kod / Code 13000 005568

KOD CODE	İÇERİK CONTENTS	☐	TL/Ad.
0255 01 0010	Süper İzole Çatal Bir Ağız Anahtar 10 mm / Single Ended Open Jaw Wrench Super Insulated	1	11.523,75
0255 01 0011	Süper İzole Çatal Bir Ağız Anahtar 11 mm / Single Ended Open Jaw Wrench Super Insulated	1	
0255 01 0012	Süper İzole Çatal Bir Ağız Anahtar 12 mm / Single Ended Open Jaw Wrench Super Insulated	1	
0255 01 0013	Süper İzole Çatal Bir Ağız Anahtar 13 mm / Single Ended Open Jaw Wrench Super Insulated	1	
0255 01 0014	Süper İzole Çatal Bir Ağız Anahtar 14 mm / Single Ended Open Jaw Wrench Super Insulated	1	
0255 01 0017	Süper İzole Çatal Bir Ağız Anahtar 17 mm / Single Ended Open Jaw Wrench Super Insulated	1	
0255 01 0019	Süper İzole Çatal Bir Ağız Anahtar 19 mm / Single Ended Open Jaw Wrench Super Insulated	1	
0255 01 0022	Süper İzole Çatal Bir Ağız Anahtar 22 mm / Single Ended Open Jaw Wrench Super Insulated	1	
0255 01 0024	Süper İzole Çatal Bir Ağız Anahtar 24 mm / Single Ended Open Jaw Wrench Super Insulated	1	
0435 03 0010	Süper İzoleli Bir Ağız Yıldız Anahtar 10 mm / Single Ended Ring Wrench Super Insulated	1	
0435 03 0011	Süper İzoleli Bir Ağız Yıldız Anahtar 11 mm / Single Ended Ring Wrench Super Insulated	1	
0435 03 0012	Süper İzoleli Bir Ağız Yıldız Anahtar 12 mm / Single Ended Ring Wrench Super Insulated	1	
0435 03 0013	Süper İzoleli Bir Ağız Yıldız Anahtar 13 mm / Single Ended Ring Wrench Super Insulated	1	
0435 03 0014	Süper İzoleli Bir Ağız Yıldız Anahtar 14 mm / Single Ended Ring Wrench Super Insulated	1	
0435 03 0017	Süper İzoleli Bir Ağız Yıldız Anahtar 17 mm / Single Ended Ring Wrench Super Insulated	1	
0435 03 0019	Süper İzoleli Bir Ağız Yıldız Anahtar 19 mm / Single Ended Ring Wrench Super Insulated	1	
0435 03 0022	Süper İzoleli Bir Ağız Yıldız Anahtar 22 mm / Single Ended Ring Wrench Super Insulated	1	
0435 03 0024	Süper İzoleli Bir Ağız Yıldız Anahtar 24 mm / Single Ended Ring Wrench Super Insulated	1	



## 2. Elektro Seri Çekmece/Drawer

Kod / Code 13000 005569

KOD/CODE	İÇERİK CONTENTS	☐	TL/Ad.
13000 005148	1000V 1/2" Altı Köşe Lokma Anahtar 10 mm / Socket Wrech 6 Points	1	23.488,00
13000 005149	1000V 1/2" Altı Köşe Lokma Anahtar 11 mm / Socket Wrech 6 Points	1	
13000 005150	1000V 1/2" Altı Köşe Lokma Anahtar 12 mm / Socket Wrech 6 Points	1	
13000 005151	1000V 1/2" Altı Köşe Lokma Anahtar 13 mm / Socket Wrech 6 Points	1	
13000 005152	1000V 1/2" Altı Köşe Lokma Anahtar 14 mm / Socket Wrech 6 Points	1	
13000 005153	1000V 1/2" Altı Köşe Lokma Anahtar 15 mm / Socket Wrech 6 Points	1	
13000 005154	1000V 1/2" Altı Köşe Lokma Anahtar 16 mm / Socket Wrech 6 Points	1	
13000 005155	1000V 1/2" Altı Köşe Lokma Anahtar 17 mm / Socket Wrech 6 Points	1	
13000 005156	1000V 1/2" Altı Köşe Lokma Anahtar 19 mm / Socket Wrech 6 Points	1	
13000 005157	1000V 1/2" Altı Köşe Lokma Anahtar 22 mm / Socket Wrech 6 Points	1	
13000 005158	1000V 1/2" Altı Köşe Lokma Anahtar 24 mm / Socket Wrech 6 Points	1	
13000 005159	1000V 1/2" Altı Köşe Lokma Anahtar 27 mm / Socket Wrech 6 Points	1	
13000 005277	1000V 1/2" Cırcır Kol 36 Diş / Ratchet Handle	1	
13000 005262	1000V 1/2" Ara Kol 75 mm / Extension Bar	1	
13000 005264	1000V 1/2" Ara Kol 250 mm / Extension Bar	1	
13000 005541	1000V 1/2" İzoleli T Kol / Sliding T-Handle	1	

**3. Elektro Seri Çekmece/Drawer**

Kod / Code 13000 005570

KOD/CODE	İÇERİK CONTENTS	☐	TL/Ad.
2400 116240	1000V İzoleli Üniversal Fort Pense 240 mm Insulated Type Waterpump Pliers Universal	1	9.672,00
3020 12 6160	1000V İzoleli Elektrikçi Kombine Pense 160 mm Insulated Electrician Type Combination Pliers	1	
3220 13 6180	1000V İzoleli Elektrikçi Düz Kargaburun 180 mm Insulated Electrician Type Long Nose Pliers	1	
3700 16 6160	1000V İzoleli Elektrikçi Yan Keski 160 mm Insulated Electrician Type Side Cutter	1	
3715 16 6165	1000V İzoleli Tek Ağızlı Kablo Kesici 165 mm Insulated Cable Cutter	1	
0600 01 0010	1000V İzoleli Kurbağacık Anahtar 10" Insulated Electrician Type Adjustable Wrench	1	
03753 50 026	Elektro Mekanik Kablo Sıyırıcı 0.2-6mm Insulated Mechanical Cable Stripper	1	

**4. Elektro Seri Çekmece/Drawer**

Kod / Code 13000 005571

KOD CODE	İÇERİK CONTENTS	☐	TL/Ad.
4140 17 2575	1000V İzoleli Elektrikçi Düz Uç Tornavida 2.5x75 / Insulated Electrician Type Flat Screwdriver	1	11.270,50
4140 17 4100	1000V İzoleli Elektrikçi Düz Uç Tornavida 4x100 / Insulated Electrician Type Flat Screwdriver	1	
4140 17 5512	1000V İzoleli Elektrikçi Düz Uç Tornavida 5.5x125 / Insulated Electrician Type Flat Screwdriver	1	
4140 17 6515	1000V İzoleli Elektrikçi Düz Uç Tornavida 6.5x150 / Insulated Electrician Type Flat Screwdriver	1	
4145 18 0360	1000V İzoleli Elektrikçi Yıldız Uç Tornavida 3x60 / Insulated Electrician Type Phillips Screwdriver	1	
4145 18 4580	1000V İzoleli Elektrikçi Yıldız Uç Tornavida 4.5x80 / Insulated Electrician Type Phillips Screwdriver	1	
4145 18 6100	1000V İzoleli Elektrikçi Yıldız Uç Tornavida 6x100 / Insulated Electrician Type Phillips Screwdriver	1	
4773 19 0040	1000V Süngüsü İzoleli Lokma Uçlu Tornavida 4mm / Insulated Electrician Type Nut Spinner	1	
4773 19 0050	1000V Süngüsü İzoleli Lokma Uçlu Tornavida 5 mm / Insulated Electrician Type Nut Spinner	1	
4773 19 0055	1000V Süngüsü İzoleli Lokma Uçlu Tornavida 5.5 mm / Insulated Electrician Type Nut Spinner	1	
4773 19 0060	1000V Süngüsü İzoleli Lokma Uçlu Tornavida 6 mm / Insulated Electrician Type Nut Spinner	1	
4773 19 0070	1000V Süngüsü İzoleli Lokma Uçlu Tornavida 7 mm / Insulated Electrician Type Nut Spinner	1	
4773 19 0080	1000V Süngüsü İzoleli Lokma Uçlu Tornavida 8 mm / Insulated Electrician Type Nut Spinner	1	
4773 19 0090	1000V Süngüsü İzoleli Lokma Uçlu Tornavida 9 mm / Insulated Electrician Type Nut Spinner	1	
4773 19 0100	1000V Süngüsü İzoleli Lokma Uçlu Tornavida 10 mm / Insulated Electrician Type Nut Spinner	1	
4773 19 0110	1000V Süngüsü İzoleli Lokma Uçlu Tornavida 11 mm / Insulated Electrician Type Nut Spinner	1	
4773 19 0120	1000V Süngüsü İzoleli Lokma Uçlu Tornavida 12 mm / Insulated Electrician Type Nut Spinner	1	
4773 19 0130	1000V Süngüsü İzoleli Lokma Uçlu Tornavida 13 mm / Insulated Electrician Type Nut Spinner	1	
4773 19 0140	1000V Süngüsü İzoleli Lokma Uçlu Tornavida 14 mm / Insulated Electrician Type Nut Spinner	1	
4783 19 6120	1000V Süngüsü İzoleli Manyetik Bits Tutucu Tornavida 6.3x120 / Insulated Magnetic Bit Holder	1	
4800 00 8131	31'li Bits Takım (Plastik Kutulu) / Bit Set in Plastic Case	31	



## ELITE SERİSİ / ELITE SERIES

### Elite Serisi Takım Dolabı (7 Çekmeceli) Elite Series Workshop Trolley (7 Drawers)



- ✓ 9 Bölmeli, sağlam ABS tabla
- 9 durable ABS worktop with divisions



- ✓ Havluluk x1
- ✓ Avadanlık x2
- ✓ Askılık x1
- Paper Roll Holder
- x1 Bottle & Tins Holder
- x2 Hanger x1



- ✓ %100 açılabilir teleskopik raylar
- ✓ Devrilme emniyet sistemi
- %100 extendable telescopic slides
- Anti tilt system



- ✓ Merkezi kilit
- ✓ Mandal sistemi
- Central lock
- Handgrip Lock system



- ✓ 2 sabit, 2 hareketli frenli tekerlek Ø 125mm
- 2 swivel castors with brake
- 2 fixed castors Ø 125 mm



- ✓ Yüksek dayanımlı elektrostatik toz boya
- High strength electrostatic powder coating



- ✓ Devrilme Emniyet Sistemli %100 Açılabilir Teleskopik Rulmanlı Ray
- 100% Extendable Telescopic Ball Bearing Rail with Tipping Safety System
- ✓ Merkezi Kilit Mandal Sistemi
- Central Lock System And Handgrip Lock System
- ✓ 2 Adet Avadanlık
- 2 Pieces of Handyman
- ✓ 1 Adet Havluluk
- 1 Piece Towel Holder
- ✓ 1 Adet Alüminyum Tutma Sapı
- 1 Piece Aluminum Handle
- ✓ 2 Sabit, 2 Hareketli, Frenli Tekerlek Ø125 mm
- 2 Fixed, 2 Movable Castors with Brake Ø125 mm

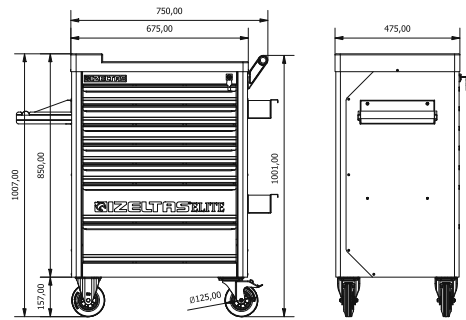

Ölçü/Size: 475x675x1007 mm

Sacdan imal edilmiş, yüksek dayanımlı elektrostatik gofrato toz boya  
Made from metal sheet, durable electrostatic embossed powder coating

KOD/CODE	ÇEKMECE DRAWERS	30 kg	30 kg	30 kg	Kg	RENK COLORS	TL/Ad
13000 005563	7	400x548x68	400x548x143	400x548x218	72.8	RAL 9005 GOF	36.362,25
13000 005572 Dolu/Full 139 Parça/Pcs	7	400x548x68	400x548x143	400x548x218	88.4	RAL 3020 GOF	80.016,25

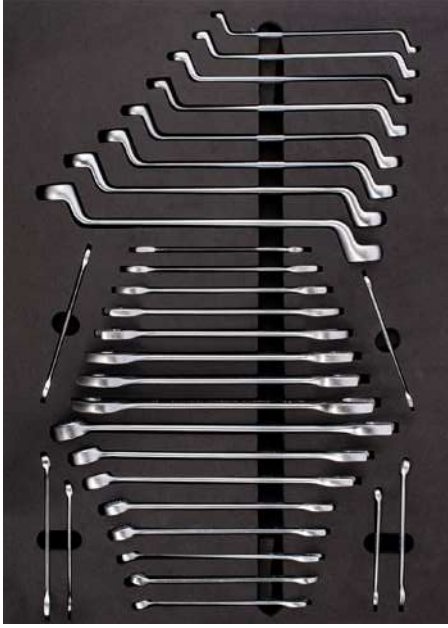

## 1. Elite Seri Çekmece/Drawer

Kod / Code 13000 005573

KOD CODE	İÇERİK CONTENTS		TL/Ad
0130	<b>İki Ağız Anahtar Uzun Boy</b> D/E Open Jaw Wrench Long Pattern 6x7 - 8x9 - 10x11 - 12x13 14x15 - 16x17 - 18x19 - 20x22 - 21x23 - 24x26	10	
0330	<b>Kombine Anahtar Uzun Boy</b> Combination Wrenches Long Pattern 6 - 7 - 8 - 9 - 10 - 11 - 12 - 13 - 14 - 17 - 19 - 22	12	7.611,50
0430	<b>Yıldız Anahtar</b> Ring Wrench 6x7 - 8x9 - 10x11 - 12x13 - 14x15 - 16x17 - 18x19 - 20x22	8	

## 2. Elite Seri Çekmece/Drawer

Kod / Code 13000 005574

KOD CODE	İÇERİK CONTENTS		TL/Ad
1113	<b>1/2" Lokmalı Allen Uçlar</b> Hexagonal Bits Socket H5-H6-H7-H8-H10-H12-H14	7	
1113	<b>1/2" Lokmalı Star Uç / 1/2 Star Bits Socket</b> T20-T25-T27-T30-T40-T45-T50-T55-T60	9	
0330	<b>Kombine Anahtar Uzun Boy</b> Combination Pliers Long 16-18	2	
4900	<b>Allen Takımı Altı Köşe / Hex Key Wrench Set</b> 2-2.5-3-3.5-4-5-6-7-8-9-10-12	12	
1107	<b>1/4" Altı Köşe Lokma Takımı</b> Socket Wrench Set 4 - 5 - 6 7 - 8 - 9 - 10 11 - 12 - 13 <b>Altı Köşe</b> Six Points <b>1/4" Cırcır Kolu</b> Ratchet Handle <b>1/4" Mafsal</b> Universal Joint <b>1/4" T Kol / Sliding T Handle</b> <b>1/4" Ara Kol / Extension Bar 50 -100 mm</b>	15	15.178,75
1113	<b>1/2" Lokma Takımı</b> Socket Wrench Set 10 - 11 - 12 13 - 14 - 15 16 - 17 - 18 19 - 21 - 22 23 - 24 - 26 27 - 28 - 30 32 <b>Altı Köşe</b> Six Points <b>1/2" Cırcır Kolu 32 Diş</b> Ratchet Handle <b>1/2" Mafsal</b> Universal Joint <b>1/2" T Kol Adaptör</b> Sliding T Handle Adapter <b>1/2" Ara Kol</b> Extension Bar 125-250 mm	24	



**3. Elite Seri Çekmece/Drawer**

Kod / Code 13000 005575

KOD CODE	İÇERİK CONTENTS		TL/Ad
3331	<b>İç Eğri Segman Pense</b> Circlip Pliers Internal (Bent) 169 mm	1	
3321	<b>İç Düz Segman Pense</b> Circlip Pliers Internal (Flat) 179 mm	1	
3311	<b>Dış Eğri Segman Pense</b> Circlip Pliers External (Bent) 160 mm	1	
3301	<b>Dış Düz Segman Pense</b> Circlip Pliers External (Flat) 170 mm	1	
3700	<b>Yan Keski Opak Seri</b> Side Cutting Pliers 160 mm	1	10.339,25
3220	<b>Düz Kargaburun Opak Seri</b> Long Nose Pliers (Flat) 200 mm	1	
3020	<b>Kombine Pense Opak Seri</b> Combination Pliers 180 mm	1	
2510	<b>Ayarlı Pense / Special Grip</b> 250 mm	1	
0600	<b>Kurbağacık Anahtar / Adjustable Wrench</b> 10"	1	
2400	<b>Üniversal Fort Pense / Waterpump Pliers</b> Universal 240 mm	1	

**4. Elite Seri Çekmece/Drawer**

Kod / Code 13000 005576

KOD CODE	İÇERİK CONTENTS		TL/Ad
4300	<b>Opak Seri Düz Uçlu Tornavida</b> Screwdriver, Opak Flat 4x100-5x125-6x150-8x175	4	
4320	<b>Opak Seri Yıldız Uçlu Tornavida</b> Screwdriver, Opak Phillips 4.5x80-6x100	2	
5800	<b>Tesviyeci Çekiç</b> Machinist's Hammer 300 gr	1	
5850	<b>Plastik Çekiç</b> Plastic Hammer ø30	1	5.898,50
5545	<b>Konik Pim Zimba</b> Drift Punch 5 mm	1	
5550	<b>Düz Pim Zimba</b> Split Pin Punch 5 mm	1	
5540	<b>Nokta Zimba</b> Center Punch 5x120	1	
5500	<b>Düz Keski</b> Flat Cold Chisel 150 mm	1	
4920	<b>T Tipi Allen Anahtar / Hex Key Wrench</b> 3-4-5-6-7-8	6	

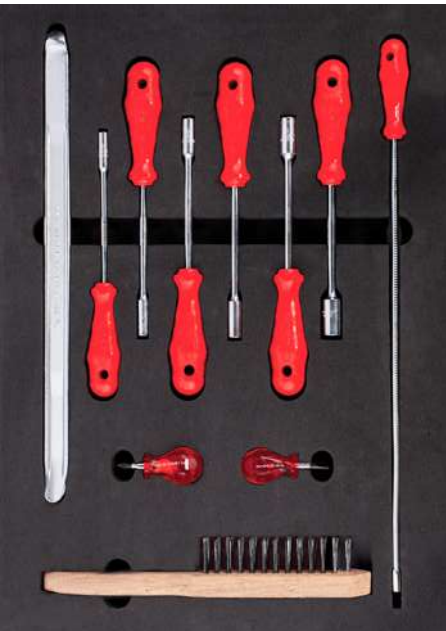

**5. Elite Seri Çekmece/Drawer**

Kod / Code 13000 005577

KOD CODE	İÇERİK CONTENTS		TL/Ad
07415	<b>Sıralı Tel Fırça 3 Sıralı</b> Hand Brush 3 Raws	1	
6350	<b>Levye Oluklu</b> Tyre Lever, Straight 400 mm	1	
6220	<b>Spiralli Miknatis</b> Flexible Magnet Holder 500 gr	1	
4110	<b>Düz Topaç Tornavida</b> Screwdriver Stubby Flat 6.5x25	1	4.626,00
4130	<b>Yıldız Topaç Tornavida</b> Screwdriver Stubby Phillips 6x25	1	
4770	<b>Lokma Uçlu Tornavida</b> Nut Spinner 6-7-8-9-10-13	6	

## Partner Seri 3 Çekmeceli Dolap Üstü Dolap

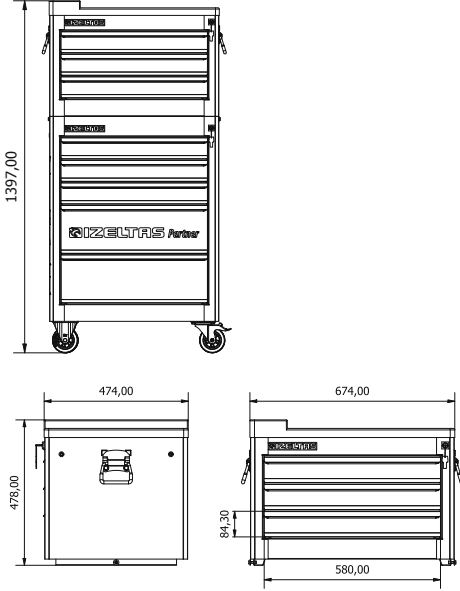

Partner Series Workshop Trolley Top Unit With 3 Drawers



Ölçü/Size: 474x674x478 mm

- ✓ Standart Tırnaklı %100 Açılabilir Teleskopik Ray
- Telescopic Slides Which Are %100 Extendable
- ✓ Merkezi Kilit Mandal Sistemi
- Central Lock System And Handgrip Lock System
- ✓ 1 Adet 9 Bölümlü Sağlam ve Dayanıklı ABS Üst Tabla
- Durable ABS Worktop With 9 Divisions

Sacdan imal edilmiş, yüksek dayanımlı elektrostatik gofrato toz boya  
Made from metal sheet, durable electrostatic embossed powder coating

KOD/CODE	ÇEKMECE DRAWERS			RENK COLORS	TL/Ad
		400x548x74			
13000 005561	3	3X	33.2	RAL 3020 GOF	19.700,00

Partner Mobil Takım Dolabı (5 Çekmeceli)  
Partner Workshop Trolley (5 Drawers)

YENİ TASARIM  
NEW DESIGN



- ✓ Merkezi kilit sistemi ve mandal sistemi
- Central lock system and handgrip lock system



- ✓ Teleskobik rulmanlı kızaklar tüm çekmeceler %100 açılabilir
- Telescopic slides which are %100 extendable.



- ✓ 5 Bölmeli, sağlam plastik enjeksiyon tabla
- Durable plastic injection worktop with 5 divisions



- ✓ 2 sabit, 2 hareketli frenli tekerlek ø 100mm
- 2 swivel castors with brake 2 fixed castors ø 100 mm



- ✓ Yüksek dayanımlı elektrostatik toz boya.
- High strength electrostatic powder coating

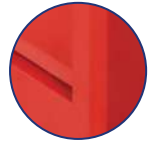

İZELTAS YOUTUBE

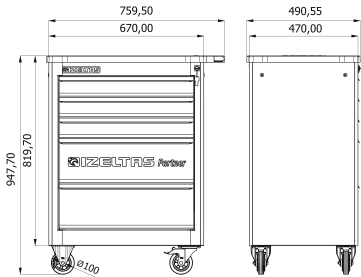

Ölçü/Size: 470x670x975 mm



RAL 3020 GOF



RAL 5003



RAL 9005 GOF

Sacdan imal edilmiş, yüksek dayanımlı elektrostatik gofrato toz boya  
Made from metal sheet, durable electrostatic embossed powder coating

KOD/CODE	ÇEKMECE DRAWERS	30 kg	30 kg	Kg	RENK COLORS	TL/Ad
8235 32 6005	5	3X	2X	56	RAL 3020 GOF	29.680,50
8235 32 5005	5	3X	2X	56	RAL 5003	29.680,50
8235 32 7005	5	3X	2X	56	RAL 9005 GOF	29.680,50
8235 00 6121 Dolu/Full 118 Parça/Pcs	5	3X	2X	72.1		61.737,50



## 1. Partner Seri Çekmece/Drawer

Kod / Code 8235 00 1072

KOD CODE	İÇERİK CONTENTS	TL/Ad
1107	<p><b>1/4" Altı Köşe Lokma Takımı</b> 1/4" Socket Wrench Set</p> <p>4 - 5 - 6 7 - 8 - 9 - 10 11 - 12 - 13 <b>Altı Köşe</b> Six Points</p> <p><b>1/4" Cırcır kolu</b> Ratchet Handle</p> <p><b>1/4" Mafsal</b> Universal Joint</p> <p><b>1/4" T Kol</b> Sliding T Handle</p> <p><b>1/4" Ara Kol</b> Extention Bar 50-100 mm</p> <p><b>1/2" Lokma Takımı</b> 1/2" Socket Set</p> <p><b>1/2" Cırcır Kolu 32 Diş</b> Ratchet Handle</p> <p>10 - 11 - 12 13 - 14 - 15 16 - 17 - 18 19 - 21 - 22 23 - 24 - 26 27 - 28 - 30 - 32</p> <p><b>1/2" Mafsal</b> Universal Joint</p> <p><b>1/2" T Kol Adaptör</b> Sliding T Handle Adapter</p> <p><b>1/2" Ara Kol</b> Extention Bar 125-250 mm</p>	15
1507	<p><b>1/4" Derin Lokma Tornavida Adaptörü</b> Spindle Handle</p>	1
4900	<p><b>12'li Allen Anahtar Takımı</b> Hex Key Wrench Set 2-2.5-3-3.5-4-5-6-7-8-9-10-12 mm</p>	12
4910	<p><b>8'li Torx® Allen Anahtar Takımı</b> Torx® Key Wrench T9-T10-T15-T20-T25-T27-T30-T40</p>	8
1108	<p><b>1/2" Altı Köşe Derin Lokma</b> Deep Socket Wrench 6 Point 10-13-16-17-18-19 mm</p>	6
1113	<p><b>1/2" 16 mm Buji Lokma Anahtar</b> Spark Plug Socket With Rubber</p>	1
2400	<p><b>240 mm Üniversal Fort Pense</b> Waterpump Pliers, Universal</p>	1
2500	<p><b>250 mm Üniversal Ayarlı Pense</b> Universal Grip</p>	1

17.082,50

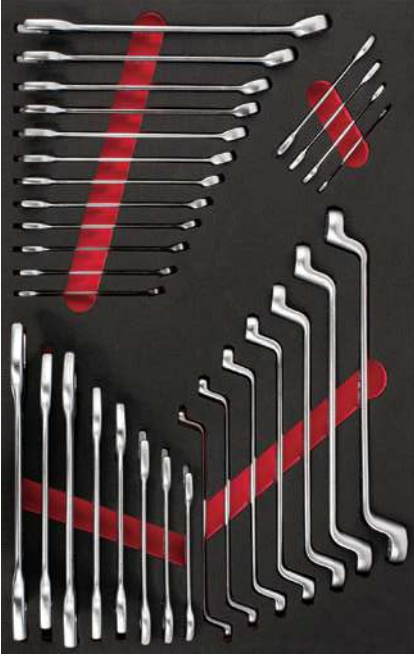
**2. Partner Seri Çekmece/Drawer**

Kod / Code 8235 00 2031

KOD CODE	İÇERİK CONTENTS	□	TL/Ad
0100	<b>İki Ağız Anahtar Kısa Boy</b> Double Ended Open Jaw Wrench Short Pattern 6x7 - 8x9 - 10x11 - 12x13 14x15 - 16x17 - 18x19 - 20x22 21x23 - 24x26 - 25x28 - 30x32	12	
0320	<b>Kombine Anahtar Kısa Boy</b> Combination Wrench Short Pattern 8 - 9 - 10 - 11 - 12 - 13 14 - 15 - 16 - 17 - 19 - 22	12	7.582,00
0430	<b>Yıldız Anahtar</b> Ring Wrench 8x9 - 10x11 - 12x13 - 14x15 - 16x17 18x19 - 20x22	7	

**3. Partner Seri Çekmece/Drawer**

Kod / Code 8235 00 3017

KOD CODE	İÇERİK CONTENTS	□	TL/Ad
4300	<b>Opak Seri Düz Uçlu Tornavida</b> Screwdriver, Opak Flat 3x80-4x80-4x100-5x125-6x150	5	
4320	<b>Opak Seri Yıldız Uçlu Tornavida</b> Screwdriver, Opak Philips 4.5x80-6x100	2	
3700	<b>Yan Keski Opak Seri</b> Side Cutting Pliers 160 mm	1	
3020	<b>Kombine Pense Opak Seri</b> Combination Pliers 180 mm	1	7.392,50
3220	<b>Düz Kargaburun Opak Seri</b> Long Nose Pliers Flat 200 mm	1	
4770	<b>Lokma Uçlu Tornavida</b> Nut Spinner 6-7-8-10-13	5	
5500	<b>Düz Keski</b> Flat Cold Chisel 150 mm	1	
5800	<b>Tesviyeci Çekiçi</b> Machinist's Hammer 500 gr	1	



## Trend Serisi Takım Dolabı (3-5-7 Çekmeceli)

Trend Series Workshop Trolley (3-5-7 Drawers)



- ✓ 4 bölmeli sağlam ve dayanıklı ABS plastik üst malzeme tabla
- Resistant and solid top cover with 4 divisions



- ✓ %100 açılabilir teleskopik raylar
- %100 extendable telescopic slides

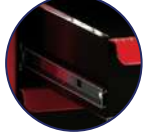

- ✓ Merkezi kilit
- Central locking



- ✓ 2 sabit, 2 hareketli frenli tekerlek ø 100 mm
- 2 swivel castors with brake 2 fixed castors ø 100 mm



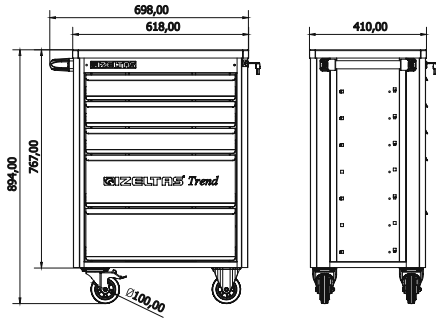

- ✓ Yüksek dayanımlı elektrostatik toz boya
- High strength electrostatic powder coating





İZELTAS YOUTUBE

Ölçü/Size: 410x618x894 mm

Sacdan imal edilmiş, yüksek dayanımlı elektrostatik gofrato toz boya  
Made from metal sheet, durable electrostatic embossed powder coating

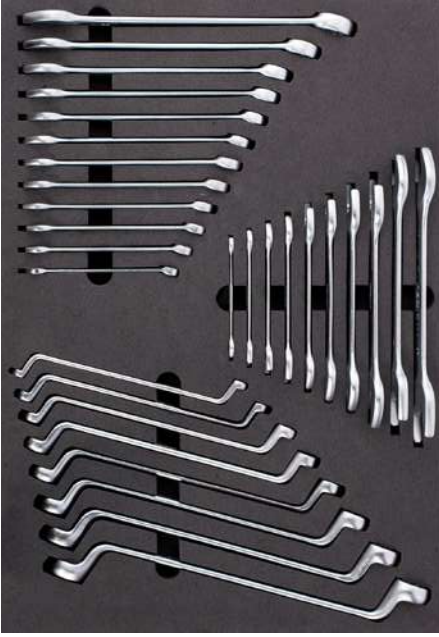
KOD/CODE	ÇEKMECE DRAWERS				RENK COLORS	TL/Ad
		350x503x82	350x503x176			
13000 005562	3	3X	--	37.8		21.308,25
8244 32 1005	5	3X	2X	40.55		21.740,00
8244 32 1007	7	7X	--	43.6		22.636,00
8244 00 5096	5	3X	2X	50.7	RAL 9005 GOF	47.384,25
Dolu/Full 93 Parça/Pcs					RAL 3020 GOF	
8244 00 7096	7	7X	--	54.9		48.280,25
Dolu/Full 93 Parça/Pcs						

**1. Trend Seri Çekmece/Drawer** Kod / Code 8244 00 1030

KOD/CODE	İÇERİK CONTENTS		TL/Ad.
0100	<b>İki Ağız Anahtar Kısa Boy</b> D/E Open Jaw Wrench Short Pattern 6x7 - 8x9 - 10x11 - 12x13 14x15 - 16x17 - 18x19 - 20x22 - 21x23 - 24x26	10	
0320	<b>Kombine Anahtar Kısa Boy</b> Combination Wrench Short Pattern 8 - 9 - 10 - 11 - 12 - 13 - 14 - 15 - 16 - 17 - 19 - 22	12	7.154,75
0430	<b>Yıldız Anahtar</b> Ring Wrench 6x7 - 8x9 - 10x11 - 12x13 - 14x15 - 16x17 18x19 - 20x22	8	

**2. Trend Seri Çekmece/Drawer** Kod / Code 8244 00 2052

KOD/CODE	İÇERİK CONTENTS		TL/Ad.
1113	<b>1/2" 17'li Lokma Takımı</b> Socket Wrench Set 1/2" mm 10 - 11 - 12 - 13 - 14 - 15 - 17 - 19 - 22 - 24 - 27 - 30 - 32 250 - 250 - 70	17	
1107	<b>1/4" Altı Köşe Lokma Takımı</b> Socket Wrench Set 1/4" mm 4 - 5 - 6 - 7 - 8 - 9 - 10 - 11 - 12 - 13 140 - 115 - 100 - 50 - 38	15	10.849,50
4900	<b>Allen Anahtar Takımı</b> Hex Key Wrench Set 2 - 2.5 - 3 - 3.5 - 4 - 5 - 6 - 7 - 8 - 9 - 10 - 12	12	
4770	<b>Lokma Uçlu Tornavidalar</b> Nutspinners 6 - 7 - 8 - 10 - 13	5	

**3. Trend Seri Çekmece/Drawer** Kod / Code 8244 00 3013

KOD/CODE	İÇERİK CONTENTS		TL/Ad.
4320	<b>Opak Seri Yıldız Uçlu Tornavida</b> Opak Screwdriver, Phillips 4.5x80-6x100	2	
4300	<b>Opak Seri Düz Uçlu Tornavida</b> Opak Screwdriver, Flat 4x100-5x125-6x150-8x175	4	
3700	<b>Yan Keski Opak Seri</b> Side Cutting Pliers 160 mm	1	
3020	<b>Kombine Pense Opak Seri</b> Combination Pliers 180 mm	1	7.640,00
3220	<b>Kargaburun Düz Uçlu Opak Seri</b> Long Nose Pliers, Flat 160 mm	1	
5500	<b>Düz Keski Krom</b> Flat Cold Chisel 150 mm	1	
5800	<b>Tesviyecici Çekici</b> Machinist Hammer 300 gr	1	
2510	<b>Special Ayarlı Pense / Special Grip 250 mm</b>	1	
2400	<b>Üniversal Fort Pense / Waterpump Pliers Universal 240 mm</b>	1	

## Takım Dolabı Ahşap Üst Tablalı XXL (7 Çekmeceli)

### XXL Series Workshop Trolley (7 Drawers)

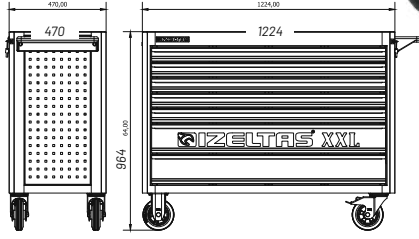

Ölçü/Size: 470x1224x964 mm

Aşağıda yazılı olan muhteviyatlı süngerlerden her bir çekmeceye İKİ (2) adet yerleştirilebilir.

- |                                |                         |
|--------------------------------|-------------------------|
| 1. Premium Seri Çekmece/Drawer | Kod / Code 8245 00 1042 |
| 2. Premium Seri Çekmece/Drawer | Kod / Code 8245 00 2094 |
| 3. Premium Seri Çekmece/Drawer | Kod / Code 8245 00 3014 |
| 4. Premium Seri Çekmece/Drawer | Kod / Code 8245 00 4043 |
| 5. Premium Seri Çekmece/Drawer | Kod / Code 8245 00 5043 |
| 6. Premium Seri Çekmece/Drawer | Kod / Code 8245 00 6009 |
| 1. Pro Seri Çekmece/Drawer     | Kod / Code 8241 00 1030 |
| 2. Pro Seri Çekmece/Drawer     | Kod / Code 8241 00 2072 |
| 3. Pro Seri Çekmece/Drawer     | Kod / Code 8241 00 3051 |
| 4. Pro Seri Çekmece/Drawer     | Kod / Code 8241 00 4027 |
| 5. Pro Seri Çekmece/Drawer     | Kod / Code 8241 00 5010 |
| 6. Pro Seri Çekmece/Drawer     | Kod / Code 8241 00 6018 |
| 1. Elite Seri Çekmece/Drawer   | Kod / Code 13000 005573 |
| 2. Elite Seri Çekmece/Drawer   | Kod / Code 13000 005574 |
| 3. Elite Seri Çekmece/Drawer   | Kod / Code 13000 005575 |
| 4. Elite Seri Çekmece/Drawer   | Kod / Code 13000 005576 |
| 5. Elite Seri Çekmece/Drawer   | Kod / Code 13000 005577 |
| 1. Partner Seri Çekmece/Drawer | Kod / Code 8235 00 1072 |
| 2. Partner Seri Çekmece/Drawer | Kod / Code 8235 00 2031 |
| 3. Partner Seri Çekmece/Drawer | Kod / Code 8235 00 3017 |

- ✓ 18mm masif üst tabla
- 18 mm solid wood top



- ✓ Ergonomik sap
- Ergonomic handle



- ✓ %100 açılabilir teleskobik raylar
- ✓ Devrilme emniyet sistemi
- %100 extendable telescopic slides
- Anti tilt system



- ✓ 2 sabit, 2 hareketli frenli tekerlek ø 150mm
- 2 swivel castors with brake
- 2 fixed castors ø 150mm





- ✓ Merkezi kilit
- ✓ Mandal sistemi
- Central lock
- Handgrip Lock system

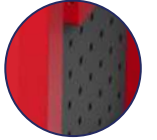

- ✓ Yüksek dayanımlı elektrostatik toz boya
- High strength electrostatic powder coating.



Sacdan imal edilmiş, yüksek dayanımlı elektrostatik gofrato toz boya  
Made from metal sheet, durable electrostatic embossed powder coating

KOD/CODE	ÇEKMECE DRAWERS			 Kg	RENK COLORS	TL/Ad
8246 32 1007	7	1098x400x60	1098x400x135	114.9	RAL 9005 GOF RAL 3020 GOF	54.426,50

8247 32 1007

Takım Dolabı Ahşap Üst Tablalı Workbench (7 Çekmeceli)  
Workbench Series Workshop Trolley (7 Drawers)

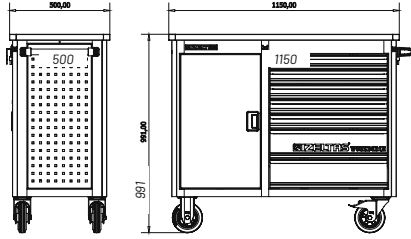
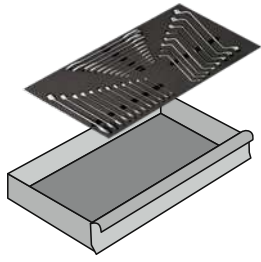

Ölçü/Size: 500x1150x991 mm

Aşağıda yazılı olan muhteviyatlı süngerlerden her bir çekmeceye BİR (1) adet yerleştirilebilir.

- |                                |                         |
|--------------------------------|-------------------------|
| 1. Premium Seri Çekmece/Drawer | Kod / Code 8245 00 1042 |
| 2. Premium Seri Çekmece/Drawer | Kod / Code 8245 00 2094 |
| 3. Premium Seri Çekmece/Drawer | Kod / Code 8245 00 3014 |
| 4. Premium Seri Çekmece/Drawer | Kod / Code 8245 00 4043 |
| 5. Premium Seri Çekmece/Drawer | Kod / Code 8245 00 5043 |
| 6. Premium Seri Çekmece/Drawer | Kod / Code 8245 00 6009 |
| 1. Pro Seri Çekmece/Drawer     | Kod / Code 8241 00 1030 |
| 2. Pro Seri Çekmece/Drawer     | Kod / Code 8241 00 2072 |
| 3. Pro Seri Çekmece/Drawer     | Kod / Code 8241 00 3051 |
| 4. Pro Seri Çekmece/Drawer     | Kod / Code 8241 00 4027 |
| 5. Pro Seri Çekmece/Drawer     | Kod / Code 8241 00 5010 |
| 6. Pro Seri Çekmece/Drawer     | Kod / Code 8241 00 6018 |
| 1. Elite Seri Çekmece/Drawer   | Kod / Code 13000 005573 |
| 2. Elite Seri Çekmece/Drawer   | Kod / Code 13000 005574 |
| 3. Elite Seri Çekmece/Drawer   | Kod / Code 13000 005575 |
| 4. Elite Seri Çekmece/Drawer   | Kod / Code 13000 005576 |
| 5. Elite Seri Çekmece/Drawer   | Kod / Code 13000 005577 |
| 1. Partner Seri Çekmece/Drawer | Kod / Code 8235 00 1072 |
| 2. Partner Seri Çekmece/Drawer | Kod / Code 8235 00 2031 |
| 3. Partner Seri Çekmece/Drawer | Kod / Code 8235 00 3017 |

- ✓ 30 mm masif ahşap üst tabla
- 30 mm solid wood top



- ✓ Standard tutma sapı
- Standard handle



- ✓ %100 açılabilir teleskobik raylar
- ✓ Devrilme emniyet sistemi
- %100 extendable telescopic slides
- Anti tilt system



- ✓ 2 sabit, 2 hareketli frenli tekerlek ø 150mm
- 2 swivel castors with brake
- 2 fixed castors ø 150mm



- ✓ Merkezi kilit
- ✓ Mandal sistemi
- Central lock
- Handgrip Lock system



- ✓ Yüksek dayanımlı elektrostatik toz boya
- High strength electrostatic powder coating

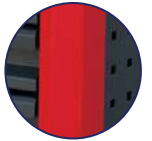

- ✓ 4 kısa, 2 uzun seperatör
- 4 Short, 2 long separators

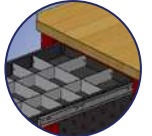

Sacdan imal edilmiş, yüksek dayanımlı elektrostatik gofrato toz boya  
Made from metal sheet, durable electrostatic embossed powder coating

KOD/CODE	ÇEKMECE DRAWERS	30 kg	30 kg	Kg	RENK COLORS	TL/Ad
8247 32 1007	7	400x548x60	400x548x134	108.9	RAL 9005 GOF RAL 3020 GOF	51.076,75

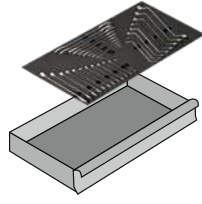
**DOLAP MUHTEVİYATLARI / TROLLEY CONTENTS**
**Premium**

Premium Seri Çekmece 1  
Premium Series Drawer 1  
Kod / Code: 8245 00 1042  
Sayfa / Page: 14

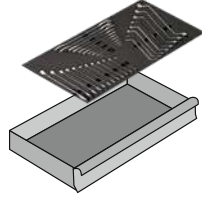
**Pro**

Premium Seri Çekmece 2  
Premium Series Drawer 2  
Kod / Code: 8245 00 2094  
Sayfa / Page: 14

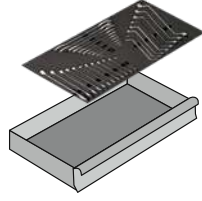
**Elite**

Premium Seri Çekmece 3  
Premium Series Drawer 3  
Kod / Code: 8245 00 3014  
Sayfa / Page: 14

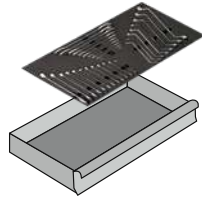
**Partner**

Premium Seri Çekmece 4  
Premium Series Drawer 4  
Kod / Code: 8245 00 4043  
Sayfa / Page: 15

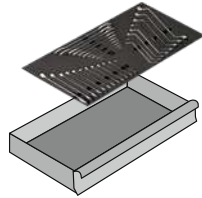
**Workbench**

Premium Seri Çekmece 5  
Premium Series Drawer 5  
Kod / Code: 8245 00 5043  
Sayfa / Page: 15

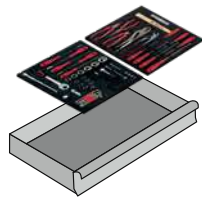
**XXL**

Premium Seri Çekmece 6  
Premium Series Drawer 6  
Kod / Code: 8245 00 6009  
Sayfa / Page: 15

## DOLAP MUHTEVİYATLARI / TROLLEY CONTENTS

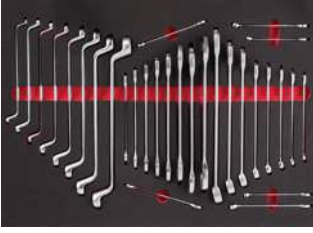

Pro Seri Çekmece 1  
Pro Series Drawer 1  
Kod / Code: 8241 00 1030  
Sayfa / Page: 18

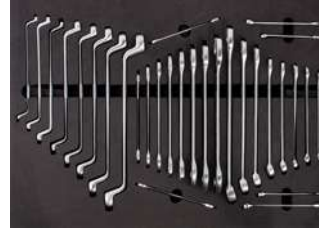

Elite Seri Çekmece 1  
Elite Series Drawer 1  
Kod / Code: 13000 005573  
Sayfa / Page: 30



Pro Seri Çekmece 2  
Pro Series Drawer 2  
Kod / Code: 8241 00 2072  
Sayfa / Page: 18



Elite Seri Çekmece 2  
Elite Series Drawer 2  
Kod / Code: 13000 005574  
Sayfa / Page: 30



Pro Seri Çekmece 3  
Pro Series Drawer 3  
Kod / Code: 8241 00 3051  
Sayfa / Page: 18



Elite Seri Çekmece 3  
Elite Series Drawer 3  
Kod / Code: 13000 005575  
Sayfa / Page: 31

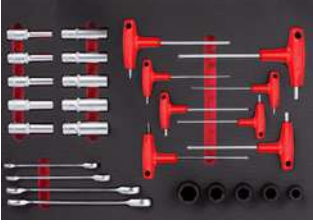

Pro Seri Çekmece 4  
Pro Series Drawer 4  
Kod / Code: 8241 00 4027  
Sayfa / Page: 19



Elite Seri Çekmece 4  
Elite Series Drawer 4  
Kod / Code: 13000 005576  
Sayfa / Page: 31



Pro Seri Çekmece 5  
Pro Series Drawer 5  
Kod / Code: 8241 00 5010  
Sayfa / Page: 19

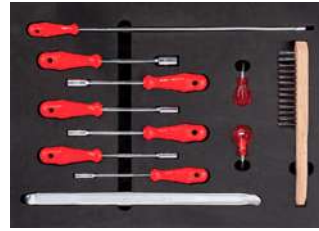

Elite Seri Çekmece 5  
Elite Series Drawer 5  
Kod / Code: 13000 005577  
Sayfa / Page: 31



Pro Seri Çekmece 6  
Pro Series Drawer 6  
Kod / Code: 8241 00 6018  
Sayfa / Page: 19



Partner Seri Çekmece 2  
Partner Series Drawer 2  
Kod / Code: 8235 00 2031  
Sayfa / Page: 35



Partner Seri Çekmece 1  
Partner Series Drawer 1  
Kod / Code: 8235 00 1072  
Sayfa / Page: 34



Partner Seri Çekmece 3  
Partner Series Drawer 3  
Kod / Code: 8235 00 3017  
Sayfa / Page: 35

**DOLAP MUHTEVİYATLARI / TROLLEY CONTENTS**

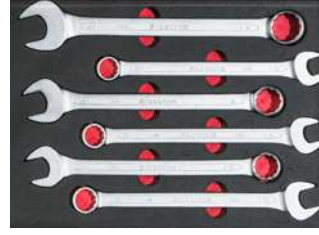

Grand Master Çekmece 1 - Sol  
Grand Master Series Drawer 1 - Left  
Kod / Code: 13000 005590  
**Sayfa / Page: 7**

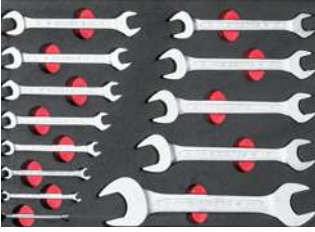

Grand Master Çekmece 1 - Sağ  
Grand Master Series Drawer 1 - Right  
Kod / Code: 13000 005589  
**Sayfa / Page: 7**

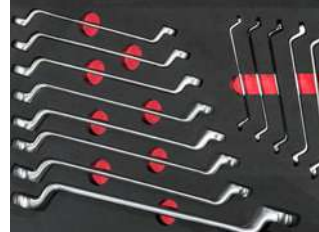

Grand Master Çekmece 2 - Sol  
Grand Master Series Drawer 2 - Left  
Kod / Code: 13000 005591  
**Sayfa / Page: 7**



Grand Master Çekmece 2 - Sağ  
Grand Master Series Drawer 2 - Right  
Kod / Code: 13000 005592  
**Sayfa / Page: 7**



Grand Master Çekmece 3 - Sol  
Grand Master Series Drawer 3 - Left  
Kod / Code: 13000 005594  
**Sayfa / Page: 8**



Grand Master Çekmece 3 - Sağ  
Grand Master Series Drawer 3 - Right  
Kod / Code: 13000 005593  
**Sayfa / Page: 8**



Grand Master Çekmece 4 - Sol  
Grand Master Series Drawer 4 - Left  
Kod / Code: 13000 005595  
**Sayfa / Page: 9**

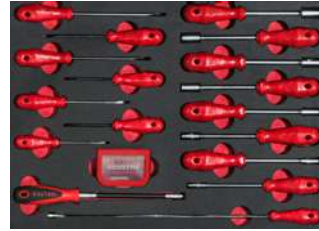

Grand Master Çekmece 4 - Sağ  
Grand Master Series Drawer 4 - Right  
Kod / Code: 13000 005596  
**Sayfa / Page: 9**



Grand Master Çekmece 5 - Sol  
Grand Master Series Drawer 5 - Left  
Kod / Code: 13000 005598  
**Sayfa / Page: 10**



Grand Master Çekmece 5 - Sağ  
Grand Master Series Drawer 5 - Right  
Kod / Code: 13000 005597  
**Sayfa / Page: 10**



Grand Master Çekmece 6 - Sol  
Grand Master Series Drawer 6 - Left  
Kod / Code: 13000 005600  
**Sayfa / Page: 11**



Grand Master Çekmece 6 - Sağ  
Grand Master Series Drawer 6 - Right  
Kod / Code: 13000 005599  
**Sayfa / Page: 11**



8210 32 6001

## Vagon Serisi Takım Dolabı

### Wagon Series Workshop Trolley

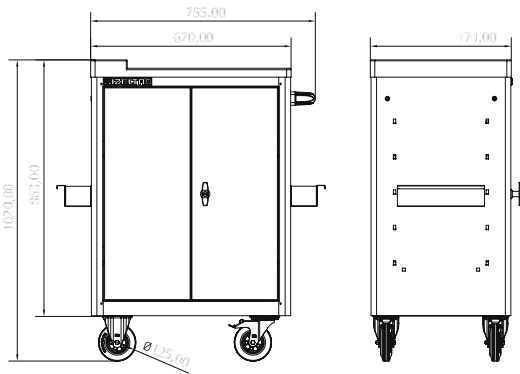

Ölçü/Size: 474x670x1020 mm



- ✓ 9 Bölmeli, sağlam ABS tabla
- Durable ABS worktop with divisions



- ✓ Kilit T Kol
- Locked T-handle

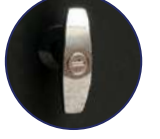

- ✓ 2 Sabit, 2 hareketli frenli tekerlek ø 125mm
- 2 swivel castors with brake 2 fixed castors ø 125 mm



- ✓ Yüksek dayanımlı elektrostatik toz boya.
- High strength electrostatic powder coating



- ✓ 2X ayarlanabilir raf (10 adet seperatör ile)
- 2x adaptable shelves with seperator 10 pcs



- ✓ Standard tutma sapı
- Standard handle

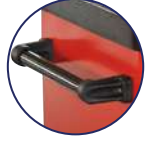

- ✓ 2X avadanlık
- 2X tin holder

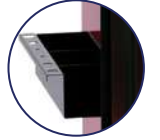

- ✓ 30 kg raf taşıma kapasitesi
- 30 kg shelf carrying capacity

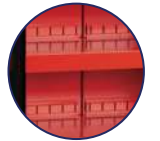

Sacdan imal edilmiş, yüksek dayanımlı elektrostatik gofrato toz boya  
Made from metal sheet, durable electrostatic embossed powder coating

KOD/CODE	ÖLÇÜ / SIZE (mm)	Kg	RENK COLORS	TL/Ad.
8210 32 6001	474x670x1020	46.87	<div style="background-color: black; color: white; padding: 2px;">RAL 9005 GOF</div> <div style="background-color: red; color: white; padding: 2px;">RAL 3020 GOF</div>	22.899,50

8160 32 6001

Takım Dolabı  
Tool Cabinet



Ölçü/Size: 310x700x1050 mm

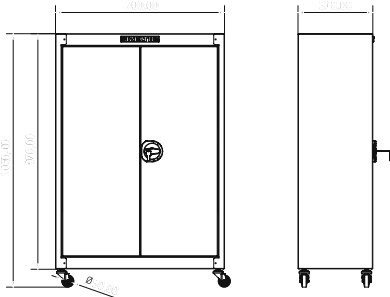

✓ Kollu kilit  
● Locked T-handle



✓ %100 açılabilir teleskobik raylar  
● %100 extendable telescopic slides



✓ 4 hareketli frenli tekerlek ø 50mm  
● 4 swivel castors with brake ø 50 mm



✓ Yüksek dayanımlı elektrostatik toz boya  
● High strength electrostatic powder coating



✓ Avadanlık x2  
● Bottle and tins holder x2



✓ Askılık x4  
● Hanger x4



✓ Özel askılık x4  
● Special hanger x4



✓ Anahtar askısı x1  
● Hanger for wrenches x1



✓ Özel avadanlık x1  
● Special tin holder x1



✓ Matkap ucu tutucu x1  
● Drill bits holder x1



Sacdan imal edilmiş, yüksek dayanımlı elektrostatik gofrato toz boya  
Made from metal sheet, durable electrostatic embossed powder coating

KOD/CODE	20 kg	ÖLÇÜ / SIZE (mm)	Kg	COLORS	TL/Ad.
8160 32 6001	3x	310x700x1050	43.62	RAL 9005 GOF RAL 3020 GOF	20.653,25

13000 005399

**Soyunma Dolabı Dar L 1800**  
 Thin Locker

- ✓ 120° derece açılabilir kapak
- 120 degree openable cover
- ✓ 10 kg raf taşıma kapasitesi
- 10 kg shelf carrying capacity
- ✓ Tek kapaklı, 2 raflı, 3 bölmeli
- Single door, 2 shelves, 3 compartments
- ✓ Birinci kalite sağlam sac metal yapı
- Premium sheet metal construction
- ✓ Yüksek dayanımlı elektrostatik toz boya
- High strength electrostatic powder coating
- ✓ 4 adet kıyafet askısı
- 4 clothes hangers
- ✓ Asma kilit takılabilen kilit mekanizması
- Padlockable locking mechanism
- ✓ Kapak alt ve üst kısımlarda havalandırma ızgaraları
- Ventilation grilles
- ✓ Dolabın dengede durmasını sağlayan, zemini çizmeyen plastik pingo ayak
- Plastic leg that provide balance and do not scratch the floor
- ✓ Kapakları gizli menteşe
- Hidden hinge
- ✓ Yan yüzeylerde kullanılan destek sacları sayesinde darbeye karşı dayanıklılık
- Impact resistant support sheets used on the side surfaces
- ✓ Birbirine kolay montajlanabilir şekilde tasarlanmıştır.
- Easy to assemble together

RAL 9005 G0F

Genişlik / Width 300 mm

RAL 7035 G0F

Derinlik / Depth 400 mm

Yükseklik / Height 1800 mm

KOD/CODE	ÖLÇÜ / SIZE (mm)	 Kg	TL/Ad.
13000 005399	300x400x1800	23.5	8.161,75

Sacdan imal edilmiş, yüksek dayanımlı elektrostatik gofrato toz boya  
 Made from metal sheet, durable electrostatic embossed powder coating

► Minimum sipariş adetlerine bağlı olarak renk seçenekleri mevcuttur. / Color options available depending on the order amount.

13000 005400

Soyunma Dolabı Geniş L 1800  
Wide Locker



- ✓ 120° derece açılabilir kapak
- 120 degree openable cover
- ✓ 10 kg raf taşıma kapasitesi
- 10 kg shelf carrying capacity
- ✓ Tek kapaklı, 2 raflı, 3 bölmeli
- Single door, 2 shelves, 3 compartments
- ✓ Birinci kalite sağlam sac metal yapı
- Premium sheet metal construction
- ✓ Yüksek dayanımlı elektrostatik toz boya
- High strength electrostatic powder coating
- ✓ 4 adet kıyafet askısı
- 4 clothes hangers
- ✓ Asma kilit takılabilen kilit mekanizması
- Padlockable locking mechanism
- ✓ Kapak alt ve üst kısımlarda havalandırma ızgaraları
- Ventilation grilles
- ✓ Dolabın dengede durmasını sağlayan, zemini çizmeyen plastik pingo ayak
- Plastic leg that provide balance and do not scratch the floor
- ✓ Kapakları gizli menteşe
- Hidden hinge
- ✓ Yan yüzeylerde kullanılan destek sacları sayesinde darbeye karşı dayanıklılık
- Impact resistant support sheets used on the side surfaces
- ✓ Birbirine kolay montajlanabilir şekilde tasarlanmıştır.
- Easy to assemble together

RAL 9005 G0F

Genişlik / Width 400 mm  
Derinlik / Depth 400 mm  
Yükseklik / Height 1800 mm

RAL 7035 G0F

KOD/CODE	ÖLÇÜ / SIZE (mm)	Kg	TL/Ad.
13000 005400	400x400x1800	26.1	9.930,75

Sacdan imal edilmiş, yüksek dayanımlı elektrostatik gofrato toz boya  
Made from metal sheet, durable electrostatic embossed powder coating

► Minimum sipariş adetlerine bağlı olarak renk seçenekleri mevcuttur. / Color options available depending on the order amount.

13000 005566

### Soyunma Dolabı Orta Dar L 900

Medium Locker Thin



13000 005567

### Soyunma Dolabı Orta Geniş L 900

Medium Locker Wide



- ✓ 120° derece açılabilir kapak
- 120 degree openable cover
- ✓ 10 kg raf taşıma kapasitesi
- 10 kg shelf carrying capacity
- ✓ Tek kapaklı, 2 bölmeli
- Single door, 1 shelves, 2 compartments
- ✓ Birinci kalite sağlam sac metal yapı
- Premium sheet metal construction
- ✓ Yüksek dayanımlı elektrostatik toz boya
- High strength electrostatic powder coating

- ✓ Asma kilit takılabilen kilit mekanizması
- Padlockable locking mechanism
- ✓ Kapak alt ve üst kısımlarda havalandırma ızgaraları
- Ventilation grilles on up and down sides of the door
- ✓ Kapakları gizli menteşe
- Hidden hinge
- ✓ Birbirine kolay montajlanabilir şekilde tasarlanmıştır.
- Easy to assemble together

RAL 9005 G0F

RAL 7035 G0F

Genişlik / Width 300 mm  
Derinlik / Depth 400 mm  
Yükseklik / Height 900 mm

RAL 9005 G0F

RAL 7035 G0F

Genişlik / Width 400 mm  
Derinlik / Depth 400 mm  
Yükseklik / Height 900 mm

Sacdan imal edilmiş, yüksek dayanımlı elektrostatik gofrato toz boya  
Made from metal sheet, durable electrostatic embossed powder coating

Sacdan imal edilmiş, yüksek dayanımlı elektrostatik gofrato toz boya  
Made from metal sheet, durable electrostatic embossed powder coating

KOD/CODE	ÖLÇÜ / SIZE (mm)	Kg	TL/Ad.
13000 005566	300x400x900	11.3	4.899,00

KOD/CODE	ÖLÇÜ / SIZE (mm)	Kg	TL/Ad.
13000 005567	400x400x900	12.9	5.959,25

► Minimum sipariş adetlerine bağlı olarak renk seçenekleri mevcuttur. / Color options available depending on the order amount.

13000 005564

Soyunma Dolabı Kısa Dar L 450  
Cube Locker Thin



13000 005565

Soyunma Dolabı Kısa Geniş L 450  
Cube Locker Wide



- ✓ 120° derece açılabilir kapak
- 120 degree openable cover
- ✓ Tek kapaklı, tek bölmeli
- Single door, 1 shelves
- ✓ Birinci kalite sağlam sac metal yapı
- Premium sheet metal construction
- ✓ Yüksek dayanımlı elektrostatik toz boya
- High strength electrostatic powder coating

- ✓ Asma kilit takılabilen kilit mekanizması
- Padlockable locking mechanism
- ✓ Kapak alt ve üst kısımlarda havalandırma ızgaraları
- Ventilation grilles on up and down sides of the door
- ✓ Kapakları gizli menteşe
- Hidden hinge
- ✓ Birbirine kolay montajlanabilir şekilde tasarlanmıştır.
- Easy to assemble together

RAL 9005 GOF

RAL 7035 GOF

Genişlik / Width 300 mm  
Derinlik / Depth 400 mm  
Yükseklik / Height 450 mm

RAL 9005 GOF

RAL 7035 GOF

Genişlik / Width 400 mm  
Derinlik / Depth 400 mm  
Yükseklik / Height 450 mm

Sacdan imal edilmiş, yüksek dayanımlı elektrostatik gofrato toz boya  
Made from metal sheet, durable electrostatic embossed powder coating

Sacdan imal edilmiş, yüksek dayanımlı elektrostatik gofrato toz boya  
Made from metal sheet, durable electrostatic embossed powder coating

KOD/CODE	ÖLÇÜ / SIZE (mm)	Kg	TL/Ad.
13000 005564	300x400x450	5.7	3.264,25

KOD/CODE	ÖLÇÜ / SIZE (mm)	Kg	TL/Ad.
13000 005565	400x400x450	6.7	3.973,00

► Minimum sipariş adetlerine bağlı olarak renk seçenekleri mevcuttur. / Color options available depending on the order amount.

13000 005560

### Çekmeceli Servis Arabası Service Trolley With Drawers

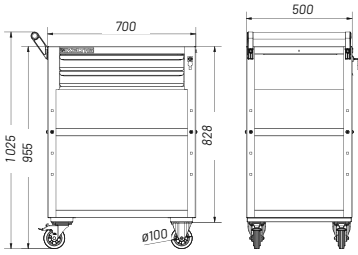

- 2X Çekmece, 30 kg Taşıma Kapasitesi  
2X Drawers, 30 kg Loading Capacity
- Merkezi Kilit Sistemi  
Central lock system
- 3 Adet Kauçuk Kaydırmaz Mat, 10 Adet Seperatör  
3X Rubber Anti Slipping Mats, 10 Separators
- 1 Adet Demonte Raf  
1X Disassembled Shelf
- 2 Adet Sabit Raf, 30 kg Taşıma Kapasitesi  
2X Fixed Shelf, loading capacity per shelf 30 kg



- ✓ %100 açılabilir teleskobik raylar  
• %100 extendable telescopic slides

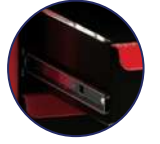

- ✓ 2 sabit, 2 hareketli frenli tekerlek ø 100 mm  
• 2 swivel castors with brake  
2 fixed castors ø 100 mm



- ✓ Merkezi kilit  
✓ Devrilme emniyet sistemi  
• Central lock  
• Anti tilt system



Sacdan imal edilmiş, yüksek dayanımlı elektrostatik gofrato toz boya  
Made from metal sheet, durable electrostatic embossed powder coating

KOD/CODE	ÖLÇÜ / SIZE (mm)	Kg	RENK COLORS	TL/Ad.
13000 005560	500x700x955	35.8	RAL 9005 GOF RAL 3020 GOF	19.211,00

8550

### Demonte Mini Servis Arabası Disassembled Mini Service Trolley

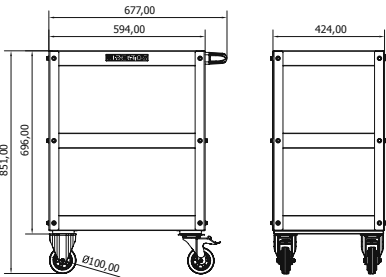

Kapalı 8550 34 8002



Açık 8550 34 8001

- 3X Kauçuk Kaydırmaz Mat  
3X Rubber Anti Slipping Mats
- 2X Sabit, 2X Hareketli Frenli Tekerlek (ø 100 mm)  
2X Fixed, 2X Swivel Castors with Brake (ø 100 mm)
- Sağlam sac metal yapı, Her raf 50 kg taşır.  
Robust sheet-steel construction, Loading capacity per shelf 50kg

Sacdan imal edilmiş, yüksek dayanımlı elektrostatik gofrato toz boya  
Made from metal sheet, durable electrostatic embossed powder coating

KOD/CODE	ÖLÇÜ / SIZE (mm)	Kg	RENK COLORS	TL/Ad.
8550 34 8001	420x590x57	22.8	RAL 9005 GOF	9.602,25
8550 34 8002	420x590x57	27.8	RAL 3020 GOF	11.073,00

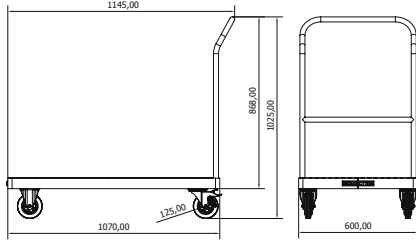
**8545 34 1005**
**Taşıma Arabası**  
**Platform Wagon**

- ✓ 12mm PVC kaplı kontrplak Tabla
- 12mm PVC coated plywood

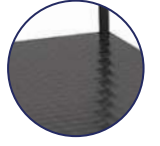

- ✓ 2 sabit, 2 hareketli frenli tekerlek ø 125 mm
- 2 swivel castors with brake
- 2 fixed castors ø 125 mm



- ✓ Sağlam sac metal yapı, 297 kg taşır
- Robust sheet-steel construction, Loading capacity 297 kg



Sacdan imal edilmiş, yüksek dayanımlı elektrostatik gofrato toz boya  
 Made from metal sheet, durable electrostatic embossed powder coating

KOD/CODE	ÖLÇÜ / SIZE (mm)	Kg	RENK COLORS	TL/Ad.
8545 34 1005	600x1145x1025	32.8	RAL 9005 GOF	29.088,00

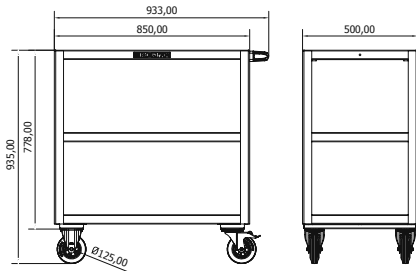
**8550 34 6001**
**Servis Arabası (Büyük Boy)**  
**Service Trolley (Large Size)**

- ✓ 3X Kaçucuk Kaydırmaz Mat
- 3X Rubber Anti Slipping Mats



- ✓ 2 sabit, 2 hareketli frenli tekerlek ø 125 mm
- 2 swivel castors with brake
- 2 fixed castors ø 125 mm



- ✓ Sağlam sac metal yapı, her raf 100 kg taşır
- Robust sheet-steel construction, Loading capacity per shelf 297 kg

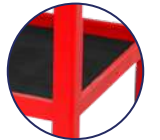

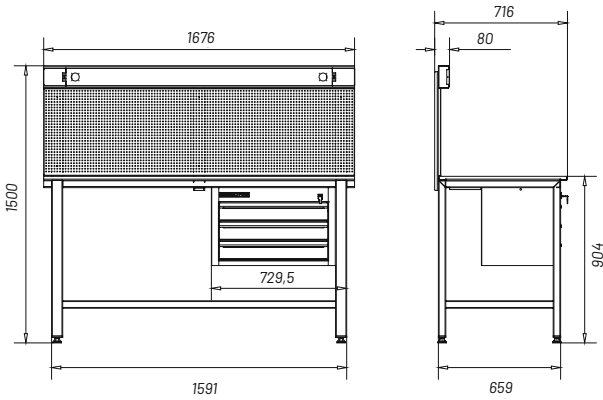

Sacdan imal edilmiş, yüksek dayanımlı elektrostatik gofrato toz boya  
 Made from metal sheet, durable electrostatic embossed powder coating

KOD/CODE	100 kg	ÖLÇÜ / SIZE (mm)	Kg	RENK COLORS	TL/Ad.
8550 34 6001	494x844x40	500x850x935	52.6	RAL 3020 GOF	15.945,50

**Servis Masası (Panolu)**  
 Workbench (With Panel)

- Merkezi kilit sistemi, mandal sistemi  
Central locking system, handgrip lock system
- Kaynaklı sağlam tasarım  
Robust welded design
- %100 Açılabilir teleskobik raylar  
100% extendable telescopic slides
- Yüksek dayanımlı elektrostatik toz boya  
High strength electrostatic powder paint
- Delikli panel (220 V prizler ile)  
Perforated panel with electrical plugs 220 V

Çelik Konstrüksiyon ve zor koşullarda çalışmaya elverişli,  
PVC kaplı kontrplak tabla, elektrostatik toz boya  
Strong and durable steel construction and  
PVC-coated plywood bench, powder coating

KOD/CODE		ÖLÇÜ / SIZE (mm)	 Kg	RENK COLORS	TL/Ad.
8500 34 6001	3X	720x1680x1495	102.8	RAL 9005 GOF RAL 3020 GOF	39.889,75

8501 34 6001

Servis Masası (Panosuz)  
Workbench (Without Panel)

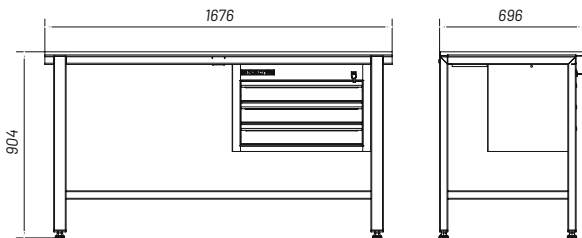

- Merkezi kilit sistemi, mandal sistemi  
Central locking system, handgrip lock system
- Kaynaklı sağlam tasarım  
Robust welded design
- %100 Açılabilir teleskobik raylar  
100% extendable telescopic slides
- Yüksek dayanımlı elektrostatik toz boya  
High strength electrostatic powder paint

Çelik Konstrüksiyon ve zor koşullarda çalışmaya elverişli,  
PVC kaplı kontrplak tabla, elektrostatik toz boya  
Strong and durable steel construction and  
PVC-coated plywood bench, powder coating

KOD/CODE	 30 kg	ÖLÇÜ / SIZE (mm)	 Kg	RENK COLORS	TL/Ad.
8501 34 6001	3X 348x548x90	700x1680x900	84.2	RAL 9005 GOF RAL 3020 GOF	30.203,00

## Demonte Atölye Masası Disassembled Workbench

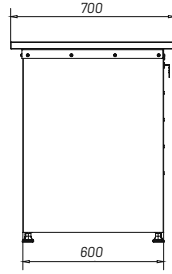
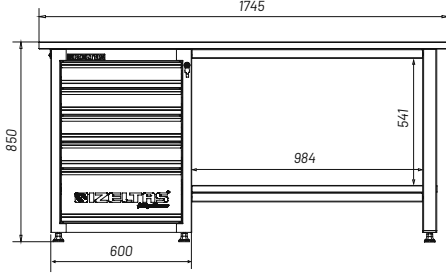

- ✓ %100 açılabilir teleskopik raylar.
- %100 extendable telescopic slides





- ✓ Merkezi kilit
- ✓ Mandal sistemi
- Central lock
- Handgrip Lock system



- Demonte sağlam tasarım  
Robust disassembled design
- 30mm masif ahşap  
30 mm solid wood
- Ayarlanabilir ayaklar  
Height adjustable feet



Sacdan imal edilmiş, yüksek dayanımlı elektrostatik gofrato toz boya  
Made from metal sheet, durable electrostatic embossed powder coating

KOD/CODE	ÇEKMECE DRAWERS			 Kg	RENK COLORS	TL/Ad
8502 34 6002	5	490x400x107	490x400x221	128.5	RAL 9005 GOF RAL 3020 GOF	101.977,75



## Çekmeceli Alet Sandığı

### Tool Chest With Drawers



- ✓ %100 açılabilir teleskobik raylar.
- %100 extendable telescopic slides

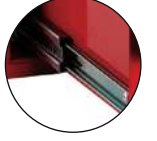



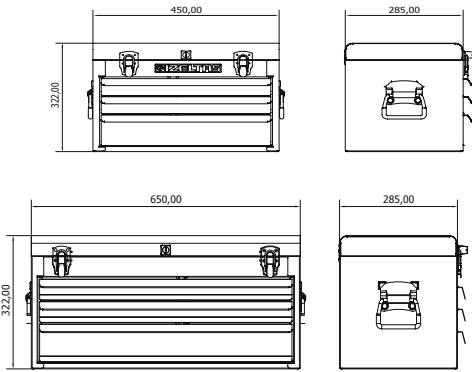

- ✓ Gergi kilit
- Tension lock



RAL 3020 GOF

Sacdan imal edilmiş, yüksek dayanımlı elektrostatik gofrato toz boya  
Made from metal sheet, durable electrostatic embossed powder coating

KOD/CODE	ÖLÇÜ / SIZE (mm)	ÇEKMECE DRAWERS	 2x	 1x	 Kg		TL/Ad
8320 33 1001	285x450x322	3X	238x370x47	238x370x87	15.2	1	13.249,25
8320 33 1003	285x650x322	3X	238x570x47	238x570x87	19.7	1	14.497,00

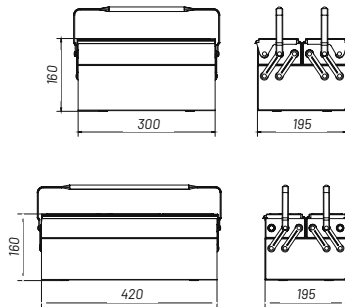
**8410**
**Takım Çantası (3 Gözlü)**  
**Tool Box (3 Trays)**

**RAL 9005 GOF**
**RAL 3020 GOF**

Sacdan imal edilmiş, yüksek dayanımlı elektrostatik gofrato toz boya  
 Made from metal sheet, durable electrostatic embossed powder coating

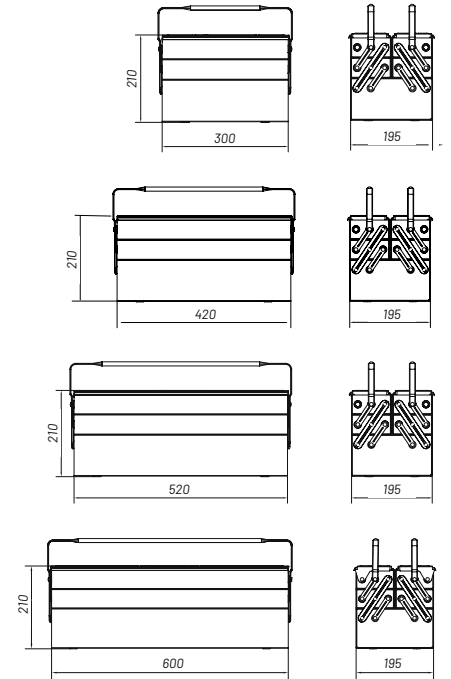
KOD CODE	ÖLÇÜ / SIZE (mm)	g	TL/Ad.
8410 33 6103	195x300x160	2230	1 1.691,00
8410 33 6203	195x420x160	2890	1 2.020,75

**8420**
**Takım Çantası (5 Gözlü)**  
**Tool Box (5 Trays)**

**RAL 9005 GOF**
**RAL 3020 GOF**

Sacdan imal edilmiş, yüksek dayanımlı elektrostatik gofrato toz boya  
 Made from metal sheet, durable electrostatic embossed powder coating

KOD CODE	ÖLÇÜ / SIZE (mm)	g	TL/Ad.
8420 33 6105	195x300x210	3070	1 2.975,50
8420 33 6205	195x420x210	3940	1 3.081,00
8420 33 6305	195x520x210	4650	1 3.580,25
8420 33 6405	195x600x210	5100	1 3.773,25

**Takım Çantası (5 Gözlü)**  
**Tool Box (5 Trays)**

Sacdan imal edilmiş, yüksek dayanımlı elektrostatik gofrato toz boya  
 Made from metal sheet, durable electrostatic embossed powder coating

**8420 00 5063**

Mekanikçi Takım Çantası (62 Parça, 5 Gözlü)  
 Tool Box for Mechanician (62 Pcs, 5 Trays)

**8420 00 5046**

Elektrikçi Takım Çantası (45 Parça, 5 Gözlü)  
 Tool Box for Electrician (45 Pcs, 5 Trays)



**8420 00 5028**

Tesisatçı Takım Çantası (28 Parça, 5 Gözlü)  
 Tool Box for Plumbers (28 Pcs, 5 Trays)



**8420 00 5063**
**Mekanikçi Takım Çantası (5 Gözlü)**  
*Tool Box for Mechanician (5 Trays)*

KOD CODE	ÖLÇÜ SIZE mm		TL/Ad.
8420 00 5063	195x420x210 <b>DOLU / FULL</b>	62	18.030,00

KOD CODE	İÇERİK CONTENTS	
05881 50 015	5 m Krom Şerit Metre Chrom Case Steel, Measuring tapes	1
4785 19 6330	6.3x30 Kısa Bits Tutucu Tornavida Screwdriver, Magnetic Bit Holder (Short)	1
4800 00 8110	10 'Lu Bits Takım Bits Set 10 (Pcs) 25 mm	10
4320	Opak Seri Yıldız Uçlu Tornavida Screwdriver, Opak, Flat 4.5x80-6x100	2
4300	Opak Seri Düz Uçlu Tornavida Screwdriver, Opak, Philips 3x80-4x100-5x125-6x150	4
4550 17 0135	135mm Kontrol Kalemli Voltage Tester	1
2400 11 0240	240mm Üniversal Fort Pense Water Pump Pliers Universal	1
1113	1/2" Lokma Anahtar Socket Wrench 10-11-12-13-14-15-17 19-22-24-27-30-32	13
1513 06 4250	1/2" Uzun Ara Kol Extension Bar Long 250 mm	1
1513 06 4070	1/2" Mafsalsal Universal Joint 70 mm	1
1513 06 0032	1/2" Cırcır Kol 32 Dişli Ratchet Handle 250 mm	1
4900 00 3112	12 'Li Allen Anahtar Takım 6 Köşe Hex Key Wrench Set 2-2.5-3-3.5-4-5-6-7-8-9-10-12	12
0320	Kısa Kombine Anahtar Combination Wrench Short Pattern 8-9-10-11-12-13 14-17-19-22	10
3700 16 2160	160mm Yan Keski Opak Seri Side Cuting Nippers, Opak insulated	1
3020 12 2180	180mm Kombine Pense Opak Seri Combination Pliers, Opak Insulated	1
3220 13 2160	160mm Düz Kargaburun Opak Seri Long Nose Pliers, Flat, Opak Insulated	1

**8420 00 5046**
**Elektrikçi Takım Çantası (5 Gözlü)**  
*Tool Box for Electrician (5 Trays)*

KOD CODE	ÖLÇÜ SIZE mm		TL/Ad.
8420 00 5046	195x420x210 <b>DOLU / FULL</b>	45	20.550,25

KOD CODE	İÇERİK CONTENTS	
05881 50 005	5m Plastik Şerit Metre Plastic Measuring Tape	1
4783 19 6120	1000V İzoleli Manyetik Bits Tutucu Tornavida Screwdriver, Magnetic Bit Holder Insulated 6.3x120	1
4800 00 8106	6 'Li Bits Takım Bits Set (6 Pcs)	6
0600 01 1010	10" Kurbağacık Anahtar Adjustable Jaw Wrench	1
4140-4145	1000V İzoleli Elektrikçi Düz, Yıldız Tornavida Insulated Electrician type Flat Screw- driver, Phillis 1000V 4x100-5.5x125 - 4.5x80-6x100	4
4550 17 0135	135mm Kontrol Kalemli Voltage Tester	1
4550 17 0190	190mm Kontrol Kalemli Voltage Tester	1
4773	1000V Süngüsü İzoleli Lokma Uçlu Tornavida Nut Spinner, Electrician Blode Insulated 1000V 6-7-8-10-13	5
0340	Cırcır Kombine Anahtar Combination Wrench With Ratchet 8-10-12-13-17-19	6
4900 00 3110	10 'Lu Allen Anahtar Takımı (mm) Hex Key Wrench Set 10 pcs 2-2.5-3-4-5-6-7-8-9-10	10
4500-4520	Klemens Tornavida (Düz-Yıldız) Screwdriver, Electronic (Flat-Phillips) 3x80-3x100-3x125-3x60-4x80	5
3700 16 6160	1000V İzoleli Elektrikçi 160mm Yan Keski Insulated Electrician Type Side Cutter 1000V	1
3020 12 6180	1000V İzoleli Elektrikçi 180mm Kombine Pense Insulated Electrician Type Combination Plier 1000V	1
3220 13 6160	1000V İzoleli Elektrikçi 160mm Kargaburun Düz Insulated Electrician Type Nose Plier 1000V	1

**8420 00 5028**
**Tesisatçı Takım Çantası (5 Gözlü)**  
*Tool Box for Plumbers (5 Trays)*

KOD CODE	ÖLÇÜ SIZE mm		TL/Ad.
8420 00 5028	195x420x210 <b>DOLU / FULL</b>	28	17.715,50

KOD CODE	İÇERİK CONTENTS	
0600 01 1010	10" Kurbağacık Anahtar 10" Adjustable Wrench	1
0600 01 1012	12" Kurbağacık Anahtar 12" Adjustable Jaw Wrench PVC Insulated	1
2400 11 0240	240 Üniversal Fort Pense 240 Waterpump Pliers, Universal	1
2100 10 0012	12" Stilson Boru Anahtarı 12" Pipe Wrench, Stillson	1
4901 22 1270	1/2" Sae Allen Anahtar 1/2" Hex Key Wrench SAE	1
4300 17 6150	Opak Seri Düz Uçlu Tornavida Screwdriver, Opak, Slotted 6x150	1
4320 18 6100	Opak Seri Yıldız Uçlu Tornavida Screwdriver, Opak, Phillips 6x100	1
5800 25 0500	500gr Tesviyeci Çekiç Machinist Hammer	1
5500 23 0200	200mm Düz Keski Flat Cold Chiesel	1
3830 15 0250	250mm Betoncu Kerpeten Tower Pincers	1
4900 00 3112	12 'Li Allen Anahtar Takımı (mm) Hex Key Wrench Set 12 pcs 2-2.5-3-3.5-4-5-6-7-8-9-10-12	12
05881 50 015	5m Krom Şerit Metre Chrom Case Steel Measuring Tape	1
2201 10 0010	1" Maşalı Boru Anahtarı 1" Pipe Wrench	1
3700 16 2160	160mm Yan Keski Opak Seri Side Cutting Nippers, Opak insulated	1
3020 12 2180	180mm Kombine Pense Opak Seri Combination Pliers, Opak Insulated	1
3220 13 2160	160mm Düz Kargaburun Opak Seri Long Nose Pliers, Flat, Opak Insulated	1

8440

### Plastik Takım Çantası

Plastic Tool Boxes



KOD CODE	inch	ÖLÇÜ SIZE mm	g	☐	TL/Ad.
8440 33 1016	16"	413x212x186	1205	4	889,25
8440 33 1019	19"	480x267x242	1855	4	1.243,75
8440 33 1022	22"	564x310x310	2815	4	2.037,25

8445 33 1028

### Tekerlekli Plastik Takım Çantası

Plastic Mobile Tool Chest



KOD CODE	inch	ÖLÇÜ SIZE mm	g	☐	TL/Ad.
8445 33 1028	28"	380x595x420	5915	1	4.907,25

8705 00 6113

### Hobby Set Oto Tipi (13 Parça)

Hobby Set Auto Type (13 pcs)



KOD CODE	İÇERİK CONTENTS	☐	TL/Ad.
0100	İki Ağz Anahtar (Kısa Boy) Duble Ended Open Jaw Wrench Short Pattern 8x9-10x11-12x13-14x15-16x17-18x19	6	4.569,25
1841	21 mm Kovan Anahtar Bir Ağz ve Mil Single Ended Tubular Socket Wench	1	
2400	240 mm Üniversal Fort Pense Waterpump Pliers Universal	1	
3020	160 mm Kombine Pense Opak Seri Combination Pliers	1	
4240	Değişken Uçlu Tornavida Takımı Screwdriver Set Reversible 4.5x80 - 6x80	2	
5800	200 gr Tesviyeci Çekiç / Machinist Hammer	1	
6350	300 mm Levye Oluklu / Tyre Lever Straight	1	

8790 00 8106

### Bakım Onarım Seti (5 Parça)

Maintenance Set (5 Pcs)



KOD CODE	İÇERİK CONTENTS	☐	TL/Ad.
3020 12 3160	160 mm Kombine Pense Kraft Seri Combination Pliers	1	3.292,25
3220 13 3160	160 mm Kargaburun Düz Uçlu Kraft Seri Long Nose Pliers Flat	1	
3700 16 3140	140 mm Yan Keski Kraft Seri Side Cutting Pliers	1	
4100 17 5100	5x100 Kraft Seri Düz Uçlu Tornavida Screwdriver Kraft, Flat	1	
4120 18 4580	4.5x80 Kraft Seri Yıldız Uçlu Tornavida Screwdriver Kraft, Phillips	1	

**8793 00 1014**
**Bakım Seti (14 Parça)**  
**Maintenance Set (14 Pcs)**

KOD CODE	İÇERİK CONTENTS	☐	TL/Ad.
0100	İki Ağız Anahtar (Kısa Boy) Duble Ended Open Jaw Wrench Short Pattern 6x7-8x9-10x11-12x13-14x15-16x17-18x19-20x22	8	
3220 13 2160	160 mm Kargaburun Düz Uçlu Opak Seri Long Nose Pliers Flat	1	
3700 16 2140	140 mm Yan Keski Opak Seri Side Cutting Pliers	1	3.569,50
4300	4x100-6x100 Opak Seri Düz Uçlu Tornavida Screwdriver Kraft, Flat	2	
4320	4.5x80-6x100 Opak Seri Yıldız Uçlu Tornavida Screwdriver Kraft, Phillips	2	

**8786 00 1003**
**Doğada Set (3 Parça)**  
**Outdoor Set (3 Pcs)**

 İZELTAŞ USTA İŞİ  
 SOHBETLER

KOD CODE	İÇERİK CONTENTS	☐	TL/Ad.
6710 27 0230	Bağ Makası Lüks / Pruning Shears	1	
6735 27 0300	Dal Budama Testeresi / Pruning Saw	1	4.878,50
6410 25 0800	Nacak / Hatchet	1	

**8779 00 8741**
**Motosiklet Bakım Seti (42 Parça)**  
**Biker Set (42 Pcs)**

KOD CODE	İÇERİK CONTENTS	☐	TL/Ad.
0100	İki Ağız Anahtar Kısa Boy Double Ended Open Jaw Wrench Short Pattern 8x9 - 10x11 - 12x13 - 14x15 - 16x17	5	
0600 01 1008	Kurbağacak Anahtar 8" Adjustable Wrench	1	
1107	1/4" Altı Köşe Lokma Anahtar Socket Wrench 6 Point 6 - 8 - 10 - 11 - 12 - 13	6	
1107 06 5010	1/4" Bits Tutucu Lokma Miknatıslı Bit Holder Socket	1	
4240 00 7102	Değişken Uçlu Tornavida Takımı Screwdriver Set Reversible	2	6.106,50
4800 00 8106	6'lı Bits Set (25 mm) Bit Set 6 Pcs	6	
4900 00 3110	Allen Anahtar Takımı 10 Parça Hex Set Wrench Set (10 Pcs)	10	
4910 00 7108	Torx® Allen Anahtar Takımı 8 Parça Torx® Key Wrench Set (8 Pcs)	8	
1507 06 0050	1/4" Ara Kol 50 mm Extension Bar	1	
1507 06 2140	1/4" Cırcır Kolu 140 mm Ratchet Wrench	1	
1507 06 4080	1/4" Derin Tornavida Adaptörü Spindle Handle	1	

**13000 005376**
**Bisiklet Onarım Seti (3 Parça)**  
**Bike Repair Kit (3 Pcs)**

KOD CODE	İÇERİK CONTENTS	☐	TL/Ad.
	Sele Altı Çanta / Bicycle Seat Bag	1	
	Multi Tool	1	1.894,75
13000 005376	Hediye Zefal Yama Seti / Zefal Bike Patch Kit	1	

# Farkını Gösteren Ustalara.

**IZELTAS**  
**BLACK LINE**



**KOD / CODE : 13000 005133**

KOD CODE	İÇERİK CONTENTS	
13000 005118	Kombine Pense 180 mm Combination Pliers 180 mm	1
13000 005117	Kargaburun Düz Uçlu 180 mm Long Nose Pliers Flat 180 mm	1
13000 005119	Yan Keski 160 mm Side Cutter 160 mm	1
13000 005116	Düz Uçlu Tornavida 6x100 Screwdriver Flat 6x100	1
13000 005120	Yıldız Uçlu Tornavida 6x100 Screwdriver Philips 6x100	1

8795 00 6005

**1000V İzoleli Elektrikçi Seti (5 Parça)**  
1000V Insulated Tool Set (5 Pcs)



İZELTAS YOUTUBE

KOD CODE	İÇERİK CONTENTS	TL/Ad.
3020 12 6180	180 mm 1000V İzoleli Elektrikçi Kombine Pense Insulated Electrician Type Combination Pliers 1000V	1
3220 13 6200	200 mm 1000V İzoleli Elektrikçi Kargaburun Insulated Electrician Type Nose Pliers	1
3700 16 6160	160 mm 1000V İzoleli Elektrikçi Yan Keski Insulated Electrician Type Nose	1
4140 17 5512	5.5x125 1000V Elektrikçi Düz Uçlu Tornavida Insulated Electrician Type Flat Screwdriver 1000V	1
4145 18 6100	6x100 1000V İzoleli Elektrikçi Yıldız Uçlu Tornavida Insulated Electrician Type Phillips Screwdriver 1000V	1



8440 00 1023

**19" Plastik Takım Çantası Elektrikçi Set (23 Parça)**  
Plastic Tool Box for Electrician 19" (23 Pcs)



KOD CODE	İÇERİK CONTENTS	TL/Ad.
8440 33 1019	19" Plastik Takım Çantası Plastic Tool Box	1
3700 16 6160	160 mm 1000V İzoleli Elektrikçi Yan Keski Insulated Electrician Type Side Cutter 1000V	1
3020 12 6180	180 mm 1000V İzoleli Elektrikçi Kombine Pense Insulated Electrician Type Combination Pliers 1000V	1
3220 13 6160	160 mm 1000V İzoleli Elektrikçi Kargaburun Düz Uçlu Insulated Electrician Type Long Nose Pliers 1000V	1
4773 19 0100	1000V Süngüsü İzoleli Lokma Uçlu Tornavida 10mm Nut Spinner, Electrician Blade Insulated 1000V	1
4773 19 0130	1000V Süngüsü İzoleli Lokma Uçlu Tornavida 13mm Nut Spinner, Electrician Blade Insulated 1000V	1
3715 16 6165	165mm 1000V İzoleli Elektrikçi Tek Ağız Kablo Kesici Cable Cutter 1000V	1
4520 18 0360	3x60 Klemens Yıldız Tornavida Electronic Screwdriver, Phillips	1
4520 18 0480	4x80 Klemens Yıldız Tornavida Electronic Screwdriver, Phillips	1
4500 17 0380	3x80 Klemens Düz Tornavida Electronic Screwdriver, Flat	1
4500 17 0480	4x80 Klemens Düz Tornavida Electronic Screwdriver, Flat	1
4140 17 4100	4x100 1000V İzoleli Elektrikçi Düz Tornavida Insulated Electrician Type Flat Screwdriver 1000V	1
4145 18 4580	4,5x80 1000V İzoleli Elektrikçi Yıldız Tornavida Insulated Electrician Type Phillips Screwdriver 1000V	1
4145 18 6100	6x100 1000V İzoleli Elektrikçi Yıldız Tornavida Insulated Electrician Type Phillips Screwdriver 1000V	1
4550 17 0190	190 mm Kontrol Kalem Voltage Tester Flat	1
4560 18 0190	190 mm Yıldız Kontrol Kalem Voltage Tester Phillips	1
4783 19 6120	6.3x120 1000V İzoleli Elektrikçi Manyetik Bits Tutucu Tornavida Screwdriver, Magnetic Bit Holder Insulated 1000V	1
4800 00 8106	6 li Bits Set ( 25 mm ) Bit Set 6 Pcs	6

13000 005538

### Elektro Takım Çantası (24 Parça)

#### Electro Tool Bag (24 Pcs)



KOD CODE	İÇERİK CONTENTS	☐	TL/Ad.
03752 50 625	Kablo Sıyrıcı Cable Stripper	1	
05881 50 005	Plastik Şerit Metre Plastic Steel Case, Measuring tapes	1	
3020 12 6180	1000V İzoleli Elektrikçi Kombine Pense 180mm Insulated Electrician Type Combination Pliers 1000V	1	
3220 13 6180	1000V İzoleli Elektrikçi Kargaburun Düz Uçlu 180mm Insulated Electrician Type Long Nose Pliers 1000V	1	
3700 16 6160	1000V İzoleli Elektrikçi Yan Keski 160mm Insulated Electrician Type Side Cutter 1000V	1	
4140	1000V İzoleli Elektrikçi Düz Uçlu Tornavida 2.5x75 - 4x100 - 5.5x125 Insulated Electrician Type Flat Screwdriver 1000V	3	
4145	1000V İzoleli Elektrikçi Yıldız Uçlu Tornavida 3x60 - 4.5x80 - 6x100 Insulated Electrician Type Phillips Screwdriver 1000V	3	24.971,00
4550 17 0190	Elektrik Kontrol Kalem 190mm (Düz Uçlu) Voltage Tester (Flat)	1	
13000 005263	1000V 1/2" Altı Köşe Lokma Anahtar (mm) Socket Wrench 6 Points 1000V (mm) 10 - 11 - 12 - 13 - 14 - 15 - 16 - 17 - 19	9	
13000 005277	1000V 1/2" Ara Kol 125mm Extension Bar 1000V	1	
	1000V 1/2" Cırcır Kolu (32 Diş) Ratchet Handle 1000V (32 Teeth)	1	

14000 004136

### Sırt Takım Çantası

#### Tool Backpack



#### Özellikler

- Su geçirmez, sağlam, dayanıklı ve uzun ömürlü, 690 denye imperteks kumaş, 600 denye imperteks astar
- Koruma sağlayıcı güçlendirilmiş sağlam plastik taban
- Maksimum düzeni sağlayan reflektörlü ön ve iç cepler
- Laptop bölmesi, sık kullanılan el aletleri için cepli çıkarılabilir ayraç
- Yumuşak pedli sırt desteği
- Yan mataralıklar

#### Features

- Waterproof, solid, resistant and long-lasting, 690 denier impertex fabric, 600 denier impertex undercoat
- Protection provider, reinforced, solid plastic base
- Reflective front and interior pockets for maximum organization
- Laptop compartment, removable divider with pockets for frequently used tools
- Back support with soft pad
- Side bottle pockets

Bu çanta boş olarak satılmaktadır  
This backpack is sold empty

KOD/CODE	ÖLÇÜ / SIZE (cm) E x B x Y W x L x H	g	☐	TL/Ad.
14000 004136	46x38x18	1330	1	3.104,25

14000 005148

 Pro Sirt Takım Çantası  
 Pro Tool Backpack

## Özellikler

- Su geçirmez, sağlam, dayanıklı ve uzun ömürlü, 1680 denye imperteks kumaş, 600 denye imperteks astar
- Koruma sağlayıcı güçlendirilmiş sağlam plastik taban
- Maksimum düzeni sağlayan reflektörlü fermuarlı cepler
- Laptop bölmesi, sık kullanılan el aletleri için cepli çıkarılabilir ayraç
- Yumuşak pedli sırt desteği
- Yan cepler

## Features

- Waterproof, solid, resistant and long-lasting, 1680 denier impertex fabric, 600 denier impertex undercoat
- Protection provider, reinforced, solid plastic base
- Reflective front and interior zip pockets for maximum organization
- Laptop compartment, removable divider with pockets for frequently used tools
- Back support with soft pad
- Side pockets

 Bu çanta boş olarak satılmaktadır  
 This backpack is sold empty

KOD/CODE	ÖLÇÜ / SIZE (cm) E x B x Y W x L x H	g	TL/Ad.
14000 005148	40x46x18	2320	5.200,00

14000 006059

 Tekerlekli ve Çekçekli Sirt Takım Çantası  
 Tool Backpack with Wheels and Pull Handle

## Özellikler

- Su geçirmez, sağlam, dayanıklı ve uzun ömürlü, 1900 denye imperteks kumaş, 600 denye imperteks astar
- Koruma sağlayıcı güçlendirilmiş sağlam plastik taban
- Lastikli yan cepler
- Ayarlanabilir, kilitli çekçek kolu ve rahat taşıma için tekerlekler
- Dik durmayı sağlayan ayaklar
- Önde kilitli kapak
- Omuz askılarında destekli pet

## Features

- Waterproof, solid, resistant and long-lasting, 1900 denier impertex fabric, 600 denier impertex undercoat
- Protection provider, reinforced, solid plastic base
- Elasticated side pockets
- Adjustable, lockable pull handle and wheels for easy transport
- Footrests for upright standing
- Lockable front lid
- Padded shoulder straps

 Bu çanta boş olarak satılmaktadır  
 This backpack is sold empty

KOD/CODE	ÖLÇÜ / SIZE (cm) E x B x Y W x L x H	g	TL/Ad.
14000 006059	37x53x24	2580	5.720,00

 YENİ  
 NEW

14000 004133

### Büyük Boy Bez Takım Çantası

#### Large Tool Bag



#### Özellikler

- Su geçirmez, sağlam, dayanıklı ve uzun ömürlü, 690 denye imperteks kumaş, 600 denye imperteks astar.
- Koruma sağlayıcı güçlendirilmiş sağlam plastik taban
- Maksimum düzeni sağlayan reflektörlü ön cepler, çoklu arka ve iç cepler
- Özel el aleti bölmeli, geniş iç alan
- Ayarlanabilir omuz askısı ile kolay taşıma

#### Features

- Waterproof, solid, resistant and long-lasting, 690 denier impertex fabric, 600 denier impertex undercoat
- Protection provider, reinforced, solid plastic base
- Reflective front pockets with multiple back and interior pockets for maximum organization
- Wide interior space with special tool compartment
- Easy carrying with adjustable shoulder strap



Bu çanta boş olarak satılmaktadır  
This toolbag is sold empty

KOD/CODE	ÖLÇÜ / SIZE (cm) E x B x Y W x L x H	g	TL/Ad.
14000 004133	27x49x37	1220	1 2.834,75

14000 004135

### Orta Boy Bez Takım Çantası

#### Medium Tool Bag



#### Özellikler

- Su geçirmez, sağlam, dayanıklı ve uzun ömürlü, 690 denye imperteks kumaş, 600 denye imperteks astar.
- Koruma sağlayıcı güçlendirilmiş sağlam plastik taban
- Maksimum düzeni sağlayan reflektörlü ön cepler, çoklu arka ve iç cepler
- Özel el aleti bölmeli, geniş iç alan
- Ayarlanabilir omuz askısı ile kolay taşıma

#### Features

- Waterproof, solid, resistant and long-lasting, 690 denier impertex fabric, 600 denier impertex undercoat
- Protection provider, reinforced, solid plastic base
- Reflective front pockets with multiple back and interior pockets for maximum organization
- Wide interior space with special tool compartment
- Easy carrying with adjustable shoulder strap



Bu çanta boş olarak satılmaktadır  
This toolbag is sold empty

KOD/CODE	ÖLÇÜ / SIZE (cm) E x B x Y W x L x H	g	TL/Ad.
14000 004135	38x32x26	960	1 2.702,00

14000 004134

### Küçük Boy Bez Takım Çantası Small Tool Bag



#### Özellikler

- Su geçirmez, sağlam, dayanıklı ve uzun ömürlü, 690 denye imperteks kumaş, 600 denye imperteks astar.
- Kuvvetlendirilmiş taban
- Fermuarlı fileli ön cep
- Düğmeli arka cep
- Özel el aleti bölmeli, geniş iç alan
- Rahat taşıma için deri elcik
- Yan reflektörler
- Özel metal fermuar başlığı

#### Features

- Waterproof, solid, resistant and long-lasting, 690 denier impertex fabric, 600 denier impertex undercoat
- Reinforced base
- Zippered front pocket
- Buttoned back pocket
- Wide interior space with special tool compartment
- Leather grips for comfortable carrying
- Side reflectors
- Special metal zipper head

Bu çanta boş olarak satılmaktadır  
This toolbag is sold empty

KOD/CODE	ÖLÇÜ / SIZE (cm) E x B x Y W x L x H	g	TL/Ad.
14000 004134	33x24x16	520	1 1.752,50

14000 004137

### Bel Takım Çantası Handyman Tool Belt



#### Özellikler

- Su geçirmez, sağlam, dayanıklı ve uzun ömürlü, 690 denye imperteks kumaş, 600 denye imperteks astar.
- 3 farklı boyda cebi ve 8 el aleti askısı ile maksimum düzeni sağlayan kullanışlı model
- Reflektörlü ön cep
- Ayarlanabilir ve kullanışlı sağlam kemer

#### Features

- Waterproof, solid, resistant and long-lasting, 690 denier impertex fabric, 600 denier impertex undercoat
- Maximum organization providing functional model with 3 different sized pockets and 8 tool hangers
- Reflective front pocket
- Adjustable and functional solid belt

Bu çanta boş olarak satılmaktadır  
This tool belt is sold empty

KOD/CODE	ÖLÇÜ / SIZE (cm) E x B x Y W x L x H	g	TL/Ad.
14000 004137	38x32x26	320	1 1.060,25

**ŞABLON  
BILLET****FİNAL ÜRÜN  
FINAL PRODUCT**

# ANAHTARLAR

## WRENCHES

- İki Ağız Anahtarlar  
Open Jaw Wrenches
- Kombine Anahtarlar  
Combination Wrenches
- Yıldız Anahtarlar  
Ring Wrenches
- Çakma Anahtarlar  
Slugging Wrenches
- Kurbağacık Anahtarlar  
Adjustable Wrenches

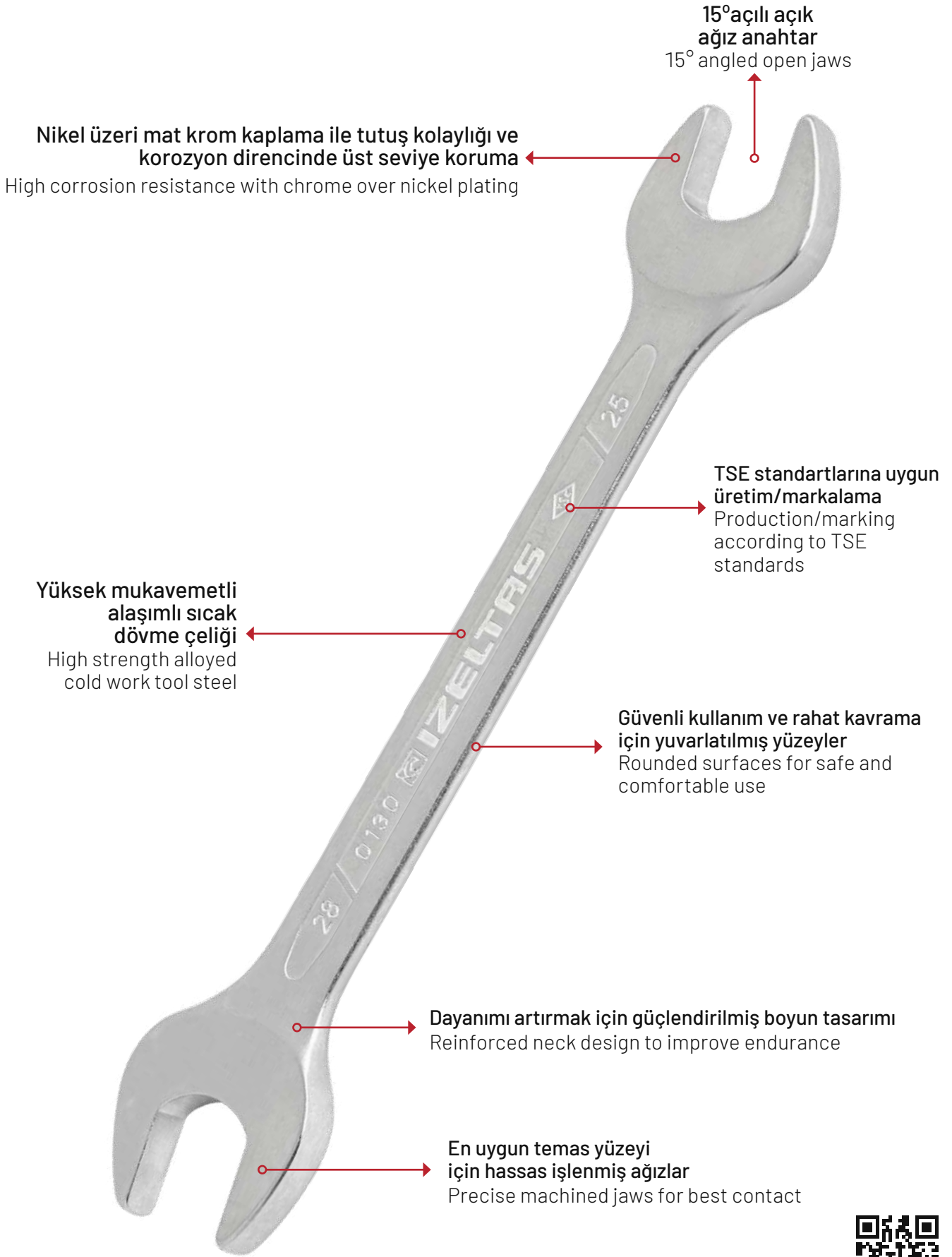

**İKİ AĞIZ ANAHTAR / DOUBLE ENDED OPEN JAW WRENCH**

0100

**İki Ağız Anahtar Kısa Boy (mm)**

Double Ended Open Jaw Wrench Short Pattern (mm)

 TS 81  
DIN 895

İZELTAS YOUTUBE

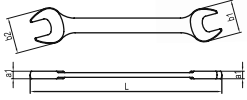
 Krom vanadyum, Krom kaplı  
Chrom vanadium, Chrom plated

KOD CODE	Ø mm	L mm	a1 mm	b1 mm	b2 mm	g	□	TL/ Ad.
0100 01 0405	4x5	97	3.5	11	12.5	15	10	102,75
0100 01 0607	6x7	97	3.5	14	16	20	10	105,50
0100 01 0809	8x9	108	4	18	20	25	10	108,50
0100 01 0810	8x10	117	4.5	18	22	30	10	119,25
0100 01 1011	10x11	120	4.6	22	24	40	10	117,75
0100 01 1012	10x12	120	4.6	22	26	40	10	117,75
0100 01 1013	10x13	120	4.6	22	28	45	10	126,00
0100 01 1213	12x13	133	5.2	26	28	60	10	130,00
0100 01 1214	12x14	147	5.2	26	30	65	10	130,00
0100 01 1314	13x14	147	5.2	28	30	70	10	130,00
0100 01 1415	14x15	147	5.8	30	32	80	10	149,50
0100 01 1317	13x17	162	6.2	28	36	90	10	170,00
0100 01 1417	14x17	162	6.2	30	36	90	10	174,00
0100 01 1617	16x17	162	6.2	34	36	105	10	174,00
0100 01 1719	17x19	178	7	36	40	135	10	187,75
0100 01 1819	18x19	178	7	38	40	135	10	187,75
0100 01 1922	19x22	195	7.4	40	46	180	10	211,00
0100 01 2022	20x22	195	7.4	42	46	180	10	217,75
0100 01 2123	21x23	213	7.7	44	48	225	10	228,75
0100 01 2224	22x24	213	8	46	50	245	10	238,50
0100 01 2426	24x26	232	8.2	50	54	295	10	245,25
0100 01 2427	24x27	232	8.2	50	56	290	10	245,25
0100 01 2528	25x28	248	8.6	52	57.5	355	10	304,00
0100 01 2732	27x32	265	9	56	66	430	10	362,75
0100 01 3032	30x32	265	9	62	66	475	10	362,75

**ÖZEL SERİLER (adet ve termin süresi isteyiniz)  
SPECIAL SERIES (ask for quantity and delivery terms)**

0100 01 0608	6x8	97	3.5	14	18	20	10	-
0100 01 0708	7x8	108	3.5	16	18	20	10	-
0100 01 0709	7x9	108	4	16	20	25	10	-
0100 01 0910	9x10	117	4.6	20	22	30	10	-
0100 01 0911	9x11	120	4.6	20	24	30	10	-
0100 01 1014	10x14	120	5.2	22	30	50	10	-
0100 01 1113	11x13	133	5.2	26	28	50	10	-
0100 01 1114	11x14	133	5.2	26	28	50	10	-
0100 01 1315	13x15	147	5.2	28	30	65	10	-
0100 01 1722	17x22	195	7.4	36	46	175	10	-
0100 01 1820	18x20	178	7	38	40	140	10	-
0100 01 1822	18x22	195	7.4	40	46	180	10	-
0100 01 1924	19x24	213	7.7	40	50	200	10	-
0100 01 2226	22x26	232	8	46	54	280	10	-
0100 01 2227	22x27	232	8.2	46	56	285	10	-
0100 01 2430	24x30	265	9	50	62	370	10	-
0100 01 2730	27x30	265	9	56	62	410	10	-

0100

**İki Ağız Anahtar Takımı Kısa Boy (mm)  
Double Ended Open Jaw Wrench  
Short Pattern Set (mm)**

KOD CODE	İÇERİK CONTENTS	g	□	TL/Ad.
0100 00 2108	6x7 - 8x9 - 10x11 12x13 - 14x15 - 16x17 18x19 - 20x22	735	8	1.190,00
0100 00 2112	6x7 - 8x9 - 10x11 12x13 - 14x15 - 16x17 18x19 - 20x22 - 21x23 24x26 - 25x28 - 30x32	2110	12	2.330,00

0130

## İki Ağız Anahtar Uzun Boy (mm)

Double Ended Open Jaw Wrench Long Pattern (mm)

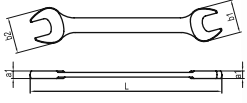
  
TS ISO 10102  
DIN 3110
Krom vanadyum, Krom kaplı  
Chrom vanadium, Chrom plated

KOD CODE	mm	L mm	a1 mm	b1 mm	b2 mm	g	TL/ Ad.
0130 01 0607	6x7	125	3.5	14	16	20	134,25
0130 01 0608	6x8	125	3.5	14	18	20	138,25
0130 01 0809	8x9	140	4	18	20	30	138,25
0130 01 0810	8x10	140	4	18	22	35	138,25
0130 01 1011	10x11	155	4.5	22	24	50	153,50
0130 01 1012	10x12	162	4.7	22	26	55	153,50
0130 01 1013	10x13	162	4.7	22	28	55	153,50
0130 01 1014	10x14	162	4.7	22	28	55	153,50
0130 01 1113	11x13	172	5	26	28	65	153,50
0130 01 1114	11x14	172	5	26	30	65	153,50
0130 01 1213	12x13	172	5	26	28	65	161,75
0130 01 1214	12x14	172	5	26	30	65	161,75
0130 01 1314	13x14	188	5.5	28	30	75	161,75
0130 01 1315	13x15	188	5.5	30	32	90	161,75
0130 01 1415	14x15	188	5.5	30	32	90	187,75
0130 01 1317	13x17	205	6.2	28	36	100	204,25
0130 01 1417	14x17	205	6.2	30	36	105	204,25
0130 01 1617	16x17	205	6.2	34	36	150	206,75
0130 01 1618	16x18	220	7	36	40	150	220,50
0130 01 1719	17x19	220	7	36	40	150	220,50
0130 01 1819	18x19	220	7	38	40	155	220,50
0130 01 1921	19x21	235	7.5	40	46	210	256,00
0130 01 1922	19x22	235	7.5	40	46	190	256,00
0130 01 2022	20x22	235	7.5	42	46	250	256,00
0130 01 1924	19x24	248	8.3	40	50	250	257,50
0130 01 2123	21x23	248	8.3	44	48	275	261,50
0130 01 2224	22x24	248	8.3	46	50	255	278,00
0130 01 2426	24x26	265	8.8	50	54	315	317,50
0130 01 2427	24x27	265	8.8	50	56	380	317,50
0130 01 2430	24x30	282	9.3	50	61.5	400	354,75
0130 01 2528	25x28	282	9.3	52	57.5	385	354,75
0130 01 2729	27x29	300	9.8	56	59	465	442,25
0130 01 2730	27x30	300	9.8	56	59	460	442,25
0130 01 2732	27x32	300	9.8	56	65.5	480	442,25
0130 01 3032	30x32	300	9.8	61.5	65.5	500	442,25
0130 01 3036	30x36	325	10.4	61.5	76	665	837,50
0130 01 3236	32x36	325	10.4	65.5	76	960	837,50
0130 01 3436	34x36	330	10.4	71	76	730	837,50
0130 01 3641	36x41	360	12	76	87	1030	1.301,25
0130 01 4146	41x46	400	12.5	87	98	1365	2.004,25
0130 01 4650	46x50	450	13	98	107	1840	2.223,00

## ÖZEL SERİLER (adet ve termin süresi isteyiniz)

## SPECIAL SERIES (ask for quantity and delivery terms)

0130 01 0555	5x5.5	125	3.5	14	16	20	10	-
0130 01 0708	7x8	135	3.5	16	18	20	10	-
0130 01 0709	7x9	140	4	16	20	30	10	-
0130 01 0910	9x10	140	4	18	22	45	10	-
0130 01 0911	9x11	155	4.5	22	24	45	10	-
0130 01 1722	17x22	235	7.5	36	46	190	5	-
0130 01 1724	17x24	248	8.3	36	50	240	5	-
0130 01 2227	22x27	265	8.8	46	56	300	5	-

0130

## İki Ağız Anahtar Takımı Uzun Boy (mm)

Double Ended Open Jaw Wrench  
Long Pattern Set (mm)



KOD CODE	İÇERİK CONTENTS	g	TL/ Ad.
0130 00 2108	6x7 - 8x9 - 10x11 - 12x13 14x15 - 16x17 - 18x19 20x22	815	8
0130 00 2112	6x7 - 8x9 - 10x11 12x13 - 14x15 - 16x17 18x19 20x22 - 21x23 24x26 - 25x28 - 27x32	2315	12

0161

## İki Ağız Anahtar Uzun Boy (SAE)

Double Ended Open Jaw Wrench Long Pattern (SAE)

TSEK

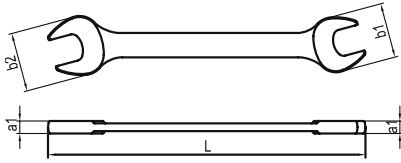

Krom vanadyum, Krom kaplı  
Chrom vanadium, Chrom plated

0161

## İki Ağız Anahtar Takımı Uzun Boy (SAE)

Double Ended Open Jaw Wrench  
Long Pattern Set (SAE)

TSEK

KOD CODE	inch	L mm	a1 mm	b1 mm	b2 mm	g	TL/ Ad.	
0161 01 0608	1/4"x5/16"	125	3.5	14	18	25	10	165,75
0161 01 0809	5/16"x3/8"	140	4	18	20	35	10	165,75
0161 01 0810	5/16"x11/32"	140	4	18	20	35	10	165,75
0161 01 0811	5/16"x7/16"	140	4	18	22	35	10	165,75
0161 01 0911	3/8"x7/16"	155	4.5	22	24	45	10	183,75
0161 01 1112	7/16"x1/2"	172	5	26	28	65	10	183,75
0161 01 1214	1/2"x9/16"	172	5	26	30	65	10	193,00
0161 01 1416	9/16"x5/8"	188	5.5	30	32	85	10	224,75
0161 01 1417	9/16"x11/16"	205	6.2	30	36	105	10	243,75
0161 01 1517	19/32"x11/16"	205	6.2	34	36	115	10	246,25
0161 01 1619	5/8"x3/4"	220	7	36	40	150	10	264,25
0161 01 1920	3/4"x25/32"	220	7	38	40	150	10	264,25
0161 01 2021	25/32"x13/16"	235	7.5	40	46	215	10	306,75
0161 01 1922	3/4"x7/8"	235	7.5	40	46	190	10	306,75
0161 01 2122	13/16"x7/8"	248	8.3	44	48	245	10	312,25
0161 01 2325	15/16"x1"	265	8.8	50	54	315	10	368,25
0161 01 2328	15/16"x1 1/8"	265	8.8	50	56	315	10	372,25
0161 01 2628	1 1/16"x1 1/8"	300	9.8	56	59.5	455	10	533,75
0161 01 2631	1 1/16"x1 1/4"	300	9.8	56	65.5	475	10	563,75
0161 01 2833	1 1/8"x1 5/16"	300	9.8	56	65.5	470	10	563,75



KOD CODE	İÇERİK CONTENTS	g	TL/ Ad.	
0161 00 2108	1/4"x5/16" - 5/16"x3/8" 7/16"x1/2" - 9/16"x5/8"-19/32"x11/16" 3/4"x25/32" - 13/16"x7/8"-15/16"x1"	1090	8	1.930,25
0161 00 2112	1/4"x5/16" - 5/16"x3/8" - 3/8"x7/16" 7/16"x1/2" - 1/2"x9/16" - 9/16"x5/8" 19/32"x11/16" - 3/4"x25/32" - 13/16"x7/8" 15/16"x1" - 1 1/16"x1 1/4" 1 1/8"x1 5/16"	2165	12	3.434,00

0250

Bir Ağız Taçlı Anahtar (mm)  
Single Ended Open Jaw Wrench (mm)

TS 81

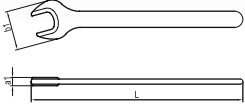

Krom vanadyum  
Chrom vanadium

KOD CODE	mm	L mm	a1 mm	b1 mm	g	TL/Ad.
0250 01 0030	30	260	10.5	60	300	1 611,75
0250 01 0036	36	300	10.5	74.5	365	1 772,00
0250 01 0041	41	345	12.2	85.5	560	1 1.005,50
0250 01 0046	46	390	14	96.5	790	1 1.082,25
0250 01 0050	50	423	15.2	105	1060	1 1.352,00
0250 01 0055	55	455	16.5	113.5	1290	1 1.810,25
0250 01 0060	60	490	17.6	121	1710	1 2.317,75
0250 01 0065	65	524	19	130	2160	1 2.824,00

ÖZEL SERİLER (adet ve termin süresi isteyiniz)  
SPECIAL SERIES (ask for quantity and delivery terms)

0250 01 0021	21	185	8	42.4	95	1	-
0250 01 0022	22	195	8	44.4	110	1	-
0250 01 0023	23	195	8	46.3	115	1	-
0250 01 0024	24	215	9	48.3	150	1	-
0250 01 0025	25	215	9	50.3	155	1	-
0250 01 0027	27	240	9.5	54.3	200	1	-
0250 01 0032	32	274	11	63	300	1	-
0250 01 0034	34	274	11	68	320	1	-
0250 01 0038	38	300	10.5	76.8	400	1	-
0250 01 0070	70	564	20.8	140	2480	1	-
0250 01 0075	75	608	21.8	151	3100	1	-

0255

Süper İzole Çatal Bir Ağız Anahtar (mm)  
Single Ended Open Jaw Wrench Super Insulated (mm)

△ 1000 V  
IEC 60900



Krom vanadyum, Krom kaplı, Kalın PVC izoleli  
Chrom vanadium, Chrom plated, Triple PVC insulated

KOD CODE	mm	L mm	g	TL/Ad.
0255 01 0010	10	110	40	10 373,00
0255 01 0011	11	120	50	10 394,25
0255 01 0012	12	130	65	10 413,00
0255 01 0013	13	140	0	10 444,25
0255 01 0014	14	155	95	10 460,00
0255 01 0017	17	170	135	10 564,25
0255 01 0019	19	185	170	10 661,50
0255 01 0022	22	200	240	10 890,00
0255 01 0024	24	220	310	10 1.088,50

0325

Montaj Anahtar (mm)  
Speed Wrench (mm)

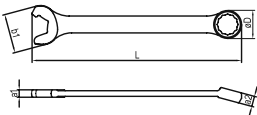

Krom vanadyum, Krom kaplı  
Chrom vanadium, Chrom plated

KOD CODE	mm	L mm	a1 mm	a2 mm	b1 mm	øD mm	g	TL/Ad.
0325 02 0010	10	135	4.3	6.9	22	15.5	35	10 235,50
0325 02 0013	13	165	5.2	7.9	28	19.5	45	10 263,00
0325 02 0017	17	205	6.4	9.8	36	25.5	110	10 347,75
0325 02 0019	19	225	7	11	40	28.5	155	10 406,50
0325 02 0020	20	230	7.2	11.4	42	30	180	10 413,25
0325 02 0021	21	242	7.4	12	44	31.5	180	10 480,25
0325 02 0022	22	250	8.2	12.6	46	33	235	10 550,25

**%100 Daha Hızlı**

Yeni tasarlanan montaj anahtarı, 2 kat hızlı cıvır mekanizması mantığına dayanan çalışma prensibinden alır. Kullanım sırasında, montaj anahtarını cıvattan ayırmadan döndürme kolaylığı kullanım hızını artırırken, cıvata köşelerine sağlam tutunan anahtar profili güvenli ve kaydırmaz kullanım sağlar.

**Uzun Ömür**

Bu yeni montaj anahtar profili, cıvata ve somunlar ile köşelerinden değil düz yüzeyleri üzerinden temas ederek düzenli tork iletimini sağlarken, gerilimin artmasını da engelleyerek anahtar ömrünün uzamasını sağlar.

- Anahtarı cıvattan ayırmadan hızlı kullanım.
- Güvenli tork iletimi ve uzun ömür.

**100% Faster**

The 100% new design speed wrench takes the 2-fold speed from the operating principle based on the ratchet mechanism logic. While in use, the ease of rotation without detaching the mounting wrench from the bolt increases the speed of use and the profile that firmly secured to the corners ensures safe and non-slip use

**Long Life**

This new mounting wrench profile by contacting bolts and nuts, not on corners, but on their flat surfaces, allows regular torque transmission, prevents the increase in surface tension and provides longer life.

- Quick use without detaching the wrench from the bolt.
- Safe torque transmission and long



İZELTAS YOUTUBE

0320

**Kombine Anahtar Kısa Boy (mm)**  
 Combination Wrench Short Pattern (mm)

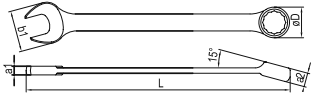
 TS 3794  
 TS ISO 7738 Form A  
 DIN 3113

 Krom vanadyum, Krom kaplı  
 Chrom vanadium, Chrom plated

0320

**Kombine Anahtar Takımı Kısa Boy (mm)**  
 Combination Wrench Short Pattern Set (mm)



KOD CODE	mm	L mm	a1 mm	a2 mm	b1 mm	øD mm	g	TL/ Ad.	
0320 02 0005	5	90	3.4	5.1	14	10	15	10	134,25
0320 02 0055	5.5	90	3.4	5.1	14	10	15	10	134,25
0320 02 0006	6	100	3.4	5.1	14	10	15	10	138,25
0320 02 0007	7	110	3.6	5.5	16	11	20	10	148,00
0320 02 0008	8	120	3.8	5.9	18	13	25	10	160,25
0320 02 0009	9	130	4	6.3	20	14	30	10	164,25
0320 02 0010	10	140	4.3	6.9	22	15.5	40	10	184,75
0320 02 0011	11	150	4.5	7.3	24	17	55	10	189,00
0320 02 0012	12	160	4.9	7.7	26	18.5	64	10	202,75
0320 02 0013	13	170	5.2	7.9	28	19.5	75	10	206,75
0320 02 0014	14	180	5.5	8.7	30	21.5	95	10	223,25
0320 02 0015	15	190	5.8	9.1	32	22.5	110	10	238,50
0320 02 0016	16	200	6.1	9.6	34	24	130	10	256,00
0320 02 0017	17	210	6.4	9.8	36	25.5	160	10	273,75
0320 02 0018	18	220	6.8	10.4	38	27	160	10	304,00
0320 02 0019	19	232	7	11	40	28.5	195	10	320,50
0320 02 0020	20	240	7.2	11.4	42	30	220	10	326,00
0320 02 0021	21	250	7.4	12	44	31.5	265	10	377,75
0320 02 0022	22	260	8.2	12.6	46	33	280	10	431,00
0320 02 0023	23	270	8.3	13	48	35	330	5	431,00
0320 02 0024	24	280	8.5	13.6	50	36.5	350	5	528,25
0320 02 0025	25	290	8.8	14	52	39	360	5	528,25
0320 02 0026	26	300	9	14.8	54	41	415	5	621,50
0320 02 0027	27	310	9.3	15	56	41.5	465	5	621,50
0320 02 0028	28	320	9.4	15.4	57.5	42.5	525	5	621,50
0320 02 0029	29	330	10	15.6	59	43.5	500	5	711,50
0320 02 0030	30	340	10.3	16	61.5	44	500	5	711,50
0320 02 0032	32	370	10.5	16.2	65.5	47	600	5	747,00
0320 02 0034	34	400	10.7	16.8	71	50	700	5	781,25

KOD CODE	İÇERİK CONTENTS	g	TL/ Ad.	
0320 00 2108	6 - 7 - 8 - 9 - 10 - 13 - 17 - 19	415	8	1.595,75
0320 00 2112	8 - 9 - 10 - 11 - 12 - 13 - 14 15 - 16 - 17 - 19 - 22	1190	12	2.849,50
0320 00 2117	6 - 7 - 8 - 9 - 10 - 11 - 12 - 13 - 14 15 - 16 - 17 - 18 - 19 - 20 - 21 - 22	1760	17	4.143,00
0320 00 2121	6 - 7 - 8 - 9 - 10 - 11 - 12 - 13 - 14 15 - 16 - 17 - 18 - 19 - 20 - 21 - 22 24 - 27 - 30 - 32	3650	21	6.750,75

### Kombine Anahtar Uzun Boy (mm) Combination Wrench Long Pattern (mm)

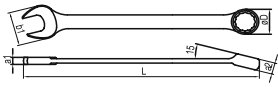

TS 3794  
TS ISO 7738 Form A  
DIN 3113



Krom vanadyum, Krom kaplı  
Chrom vanadium, Chrom plated

KOD CODE	mm	L	a1 mm	a2 mm	b1 mm	øD mm	g	TL/Ad.
0330 02 0005	5	95	3.2	5.2	12.5	9	15	10 155,00
0330 02 0055	5.5	95	3.2	5.2	12.5	9	15	10 155,00
0330 02 0006	6	105	3.8	5.6	14	10.5	20	10 155,00
0330 02 0007	7	117	4	6.1	16	12	20	10 155,00
0330 02 0008	8	130	4.2	6.6	18	13.5	30	10 180,75
0330 02 0009	9	141	4.5	7	20	15	40	10 183,75
0330 02 0010	10	154	4.7	7.6	22	16	45	10 202,75
0330 02 0011	11	166	5	8.2	24	17.5	60	10 213,50
0330 02 0012	12	178	5.2	8.7	26	19	70	10 213,50
0330 02 0013	13	190	5.6	9.2	28	20.5	80	10 239,50
0330 02 0014	14	203	5.8	9.7	30	22	95	10 249,25
0330 02 0015	15	215	6.4	10.1	32	23.5	110	10 265,75
0330 02 0016	16	227	6.4	10.8	34	25	130	10 268,25
0330 02 0017	17	239	6.6	11.4	36	26.5	150	10 304,00
0330 02 0018	18	250	7	12	38	28	155	10 328,50
0330 02 0019	19	263	7.3	12.7	40	29.5	200	10 357,25
0330 02 0020	20	275	7.7	13.2	42	31	230	10 379,25
0330 02 0021	21	288	8.1	13.3	44	31.5	260	10 403,75
0330 02 0022	22	300	8.5	13.7	46	34	290	10 480,25
0330 02 0023	23	315	8.8	14.2	48	35.5	320	5 584,25
0330 02 0024	24	330	9	14.2	50	37	350	5 584,25
0330 02 0025	25	340	9.3	14.7	52	38.5	390	5 584,25
0330 02 0026	26	350	9.7	14.7	54	40	430	5 688,50
0330 02 0027	27	360	10	15.2	56	41	465	5 688,50
0330 02 0028	28	370	10.4	15.7	57.5	43	515	5 688,50
0330 02 0029	29	390	10.8	16.2	59	44	565	5 688,50
0330 02 0030	30	410	11.2	16.6	61.5	45	625	5 791,00
0330 02 0032	32	420	11.5	17.1	65.5	48	690	5 829,25
0330 02 0034	34	430	11.8	17.4	71	50.5	775	5 845,75
0330 02 0036	36	440	12.2	17.7	76	53	895	5 957,75
0330 02 0038	38	450	12.5	18.7	80	56	980	5 979,75
0330 02 0041	41	480	13.5	19.7	87	61	1265	5 1.115,00
0330 02 0046	46	505	14.7	20.7	95	67.5	1680	1 1.514,50
0330 02 0050	50	540	15.9	22.7	104	73.5	2120	1 2.052,00

## 0330

### Kombine Anahtar Takımı Uzun Boy (mm) Combination Wrench Long Pattern Set (mm)



KOD CODE	İÇERİK CONTENTS	g	TL/Ad.
0330 00 2108	6 - 7 - 8 - 9 - 10 - 13 17 - 19	665	8 1.776,75
0330 00 2112	8 - 9 - 10 - 11 - 12 13 - 14 - 15 - 16 17 - 19 - 22	1780	12 3.157,25
0330 00 2117	6 - 7 - 8 - 9 - 10 11 - 12 - 13 - 14 - 15 16 - 17 - 18 - 19 20 - 21 - 22	2170	17 4.577,75
0330 00 2121	6 - 7 - 8 - 9 - 10 - 11 12 - 13 - 14 - 15 - 16 17 - 18 - 19 - 20 - 21 22 - 24 - 27 - 30 - 32	4465	21 7.470,25

0331

**Kombine Anahtar Uzun Boy (SAE)**  
 Combination Wrench Long Pattern (SAE)

TSEK

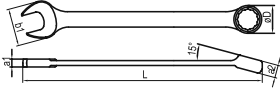
 Krom vanadyum, Krom kaplı  
 Chrom vanadium, Chrom plated

KOD CODE	inch	L mm	a1 mm	a2	b1 mm	ϕD mm	g	TL/ Ad.	
0331 02 0005	3/16"	95	3.2	5.2	12.5	9	15	10	184,75
0331 02 0006	1/4"	105	3.8	5.6	14	10.5	15	10	193,00
0331 02 0008	5/16"	130	4.2	6.6	18	13.5	30	10	223,25
0331 02 0010	3/8"	154	4.7	7.6	22	16	45	10	254,75
0331 02 0011	7/16"	166	5	8.2	24	17.5	55	10	268,25
0331 02 0013	1/2"	190	5.6	9.2	28	20.5	80	10	301,00
0331 02 0014	9/16"	203	5.8	9.7	30	22	95	10	316,25
0331 02 0015	19/32"	215	6.4	10.1	32	23.5	110	10	335,25
0331 02 0016	5/8"	227	6.4	10.8	34	25	130	10	360,00
0331 02 0017	11/16"	239	6.6	11.4	36	26.5	150	10	384,50
0331 02 0019	3/4"	263	7.3	12.7	40	29.5	195	10	447,50
0331 02 0020	25/32"	275	7.7	13.2	42	31	225	10	477,75
0331 02 0021	13/16"	288	8.1	13.3	44	31.5	255	5	528,25
0331 02 0022	7/8"	300	8.5	13.7	46	34	290	5	607,75
0331 02 0024	15/16"	330	9	14.2	50	37	350	5	743,00
0331 02 0025	1"	340	9.3	14.7	52	38.5	380	5	743,00
0331 02 0027	1 1/16"	360	10	15.2	56	41	490	5	870,25
0331 02 0028	1 1/8"	370	10.4	15.7	57.5	43	505	5	870,25
0331 02 0030	1 3/16"	410	11.2	16.6	61.5	45	620	5	996,25
0331 02 0032	1 1/4"	420	11.5	17.1	65.5	48	710	5	1.044,00
0331 02 0033	1 5/16"	430	11.8	17.4	71	50.5	790	5	1.044,00
0331 02 0038	1 1/2"	450	12.5	18.7	80	56	985	5	1.261,50

**ÖZEL SERİLER (adet ve termin süresi isteyiniz)**  
**SPECIAL SERIES (ask for quantity and delivery terms)**

0331 02 0035	1 3/8"	440	12.2	17.7	76	53	1015	5	-
0331 02 0036	1 7/16"	440	12.2	17.7	76	53	1015	5	-
0331 02 0041	1 5/8"	480	13.5	19.7	87	61	1325	5	-
0331 02 0046	1 13/16"	505	14.7	20.7	95	67.5	1750	5	-
0331 02 0050	2"	540	15.9	22.7	104	73.5	2200	5	-

0331

**Kombine Anahtar Takımı Uzun Boy (SAE)**  
 Combination Wrench Long Pattern Set (SAE)

KOD CODE	İÇERİK CONTENTS	g	TL/ Ad.	
0331 00 2108	5/16" - 3/8" - 7/16" - 1/2" - 9/16" - 5/8" 11/16" - 3/4"	925	8	2.554,75
0331 00 2112	5/16" - 3/8" - 7/16" - 1/2" - 9/16" - 5/8" 11/16" - 3/4" - 13/16" - 7/8" - 15/16" - 1"	2320	12	5.176,50
0331 00 2117	1/4" - 5/16" - 3/8" - 7/16" - 1/2" - 9/16" 19/32" - 5/8" - 11/16" - 3/4" - 25/32" 13/16" - 7/8" - 15/16" - 1" - 1 1/16" - 1 3/16"	3875	17	8.048,50
0331 00 2120	1/4" - 5/16" - 3/8" - 7/16" - 1/2" - 9/16" 19/32" - 5/8" - 11/16" - 3/4" - 25/32" 13/16" - 7/8" - 15/16" - 1" - 1 1/16" 1 1/8" - 1 3/16" - 1 1/4" - 1 5/16"	5880	20	11.006,50

### Circir Kombine Anahtar (mm) Combination Wrench With Ratchet (mm)

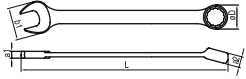

Krom vanadyum, Krom kaplı  
Chrom vanadium, Chrom plated

KOD CODE	mm	L mm	a1 mm	a2 mm	b1 mm	øD mm	g	TL/Ad.
0340 02 0008	8	136	3.2	7	18	17.5	35	666,50
0340 02 0009	9	143	3.5	7.6	20	19.3	40	665,00
0340 02 0010	10	160	3.8	7.7	22	21	50	696,75
0340 02 0011	11	169	4.1	8.3	24.5	22.7	65	700,75
0340 02 0012	12	174	4.3	8.7	26.5	24	75	759,25
0340 02 0013	13	180	4.6	9.3	27.6	26	85	813,00
0340 02 0014	14	193	5	9.4	31.4	27.7	105	837,50
0340 02 0015	15	200	5.2	10	33.4	29	125	888,25
0340 02 0016	16	216	5.4	10.6	34.6	30.7	155	1.016,75
0340 02 0017	17	233	5.6	10.9	38.4	33	195	1.076,75
0340 02 0018	18	239	5.7	11.2	39.9	33.7	205	1.167,25
0340 02 0019	19	250	6	11.5	41.5	34.8	225	1.239,50
0340 02 0021	21	285	6.4	13	45.8	42	340	1.723,75
0340 02 0022	22	285	6.4	13	45.8	42	350	1.890,75
0340 02 0024	24	325	7	14.5	51.5	47.5	475	2.135,75

## 0340

### Circir Kombine Anahtar Takımı (mm) Combination Wrench With Ratchet, Set (mm)



KOD CODE	İÇERİK CONTENTS	g	TL/Ad.
0340 00 2110	8 - 9 - 10 - 11 12 - 13 - 14 - 15 - 17 - 19	1010	10 8.342,00
0340 00 2115	8 - 9 - 10 - 11 - 12 - 13 14 - 15 - 16 - 17 - 18 - 19 - 21 - 22 - 24	2575	15 16.275,50

## 13000 005343

### Circir Kombine Anahtar Takımı (4 parça, mm) Combination Wrench With Ratchet Set (4 pcs, mm)



KOD CODE	İÇERİK CONTENTS	g	TL/Ad.
13000 005343	10 - 13 - 17 - 19	600	4 3.825,75

0345

ISO 21982

### Mafsallı Cırcır Kombine Anahtar (mm) Flexible Head Combination Wrench With Ratchet (mm)

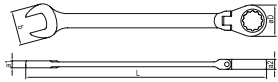

Krom vanadyum, Krom kaplı  
Chrom vanadium, Chrom plated

KOD CODE	mm	L mm	a1 mm	a2 mm	b mm	σD mm	g		TL/Ad.
0345 02 0008	8	136	5.5	7	17	17.5	40	10	1.101,25
0345 02 0009	9	140	6.1	7.7	21.5	21	55	10	1.123,25
0345 02 0010	10	140	6.1	7.7	21.5	21	60	10	1.168,50
0345 02 0011	11	142	6.4	8.3	23.5	22.5	75	10	1.204,00
0345 02 0012	12	143	6.7	8.7	26	24	80	10	1.273,75
0345 02 0013	13	156	7	9.3	27	26	100	10	1.328,50
0345 02 0014	14	164	7.3	9.4	30.5	27.5	115	10	1.397,00
0345 02 0015	15	174	7.7	10	32	29	140	10	1.465,25
0345 02 0016	16	176	8	10.6	34	30.5	155	10	1.595,25
0345 02 0017	17	195	8.3	10.9	37	32.5	185	10	1.615,75
0345 02 0018	18	213	8.6	11.2	38.5	33.5	215	10	1.739,00
0345 02 0019	19	214	9	11.5	40	35	235	10	1.817,00

0345 00 2112

### Mafsallı Cırcır Kombine Anahtar Takımı (mm) Flexible Head Combination Wrench With Ratchet, Set (mm)



KOD CODE	İÇERİK CONTENTS	g		TL/Ad.
0345 00 2112	8 - 9 - 10 - 11 - 12 - 13 14 - 15 - 16 - 17 - 18 - 19	1510	12	16.827,50

0335 02 0010

### Çoklu Yıldız Cırcır Anahtar (mm) Multi-Ring Wrench (mm)



Krom vanadyum, Krom kaplı  
Chrom vanadium, Chrom plated

KOD CODE	ÖLÇÜ SIZE	L mm	g		TL/Ad.
0335 02 0010	10x13x17x19	330	215	5	2.465,25

0370

### Boyunlu Kombine Anahtar (mm) Offset Combination Wrench (mm)



TS 3794  
TS ISO 7738 Form B  
DIN 3113

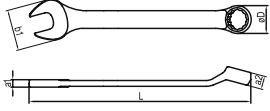

Krom vanadyum, Krom kaplı  
Chrom vanadium, Chrom plated

0370

### Boyunlu Kombine Anahtar Takımı (mm) Offset Combination Wrench, Set (mm)



KOD CODE	mm	L mm	a1 mm	a2 mm	b1 mm	σD mm	g	TL/ Ad.	
0370 02 0006	6	110	3.8	5.6	16	10.5	20	10	160,25
0370 02 0007	7	120	4	6.2	18	12	25	10	170,00
0370 02 0008	8	130	4.2	6.7	20	13	30	10	183,75
0370 02 0009	9	140	4.4	7.3	22	14.5	35	10	187,75
0370 02 0010	10	150	4.6	7.8	24	16	40	10	212,25
0370 02 0011	11	160	4.8	8.4	26	17	55	10	219,00
0370 02 0012	12	167	5	9	28	18.5	65	10	234,00
0370 02 0013	13	175	5.4	9.6	30	20	70	10	239,50
0370 02 0014	14	185	5.8	10.2	32	21.5	85	10	257,50
0370 02 0015	15	195	6.2	10.8	34	23	100	10	273,75
0370 02 0016	16	210	6.6	11.4	36	24.5	120	10	294,25
0370 02 0017	17	225	7	12	38	26	145	10	314,75
0370 02 0018	18	237	7.4	12.4	40	27.5	170	10	349,00
0370 02 0019	19	250	7.8	13	42	29	195	10	368,25
0370 02 0020	20	267	8.2	13.2	44	30.5	230	10	386,00
0370 02 0021	21	283	8.6	13.8	46	32	260	10	434,00
0370 02 0022	22	295	9.1	14.6	48	34.5	300	10	497,00
0370 02 0023	23	295	9.1	14.6	48	34.5	300	5	606,25
0370 02 0024	24	329	9.4	15.4	52	37	380	5	606,25
0370 02 0025	25	329	9.4	15.4	52	37	375	5	606,25
0370 02 0026	26	360	10.2	16.8	58	41	480	5	714,25
0370 02 0027	27	360	10.2	16.8	58	41	485	5	714,25
0370 02 0028	28	360	10.2	16.8	58	41	470	5	714,25
0370 02 0029	29	394	11	18.2	64	44.5	615	5	795,00
0370 02 0030	30	394	11	18.2	64	44.5	610	5	819,75
0370 02 0032	32	435	11.8	19.7	66	47.5	760	5	859,50
0370 02 0036	36	468	12.6	21.2	76	53	1020	5	993,25



KOD CODE	İÇERİK CONTENTS	g	TL/ Ad.	
0370 00 2108	6 - 7 - 8 - 9 - 10 - 13 - 17 - 19	665	8	1.835,50
0370 00 2112	8 - 9 - 10 - 11 - 12 - 13 - 14 15 - 16 - 17 - 19 - 22	1375	12	3.280,25
0370 00 2117	6 - 7 - 8 - 9 - 10 - 11 - 12 - 13 - 14 15 - 16 - 17 - 18 - 19 - 20 - 21 - 22	2100	17	4.778,75
0370 00 2121	6 - 7 - 8 - 9 - 10 - 11 - 12 - 13 - 14 - 15 16 - 17 - 18 - 19 - 20 - 21 - 22 - 24 - 27 30 - 32	4425	21	7.778,00

0380

**Torx® - mm Kombine Anahtar**  
**Torx® - mm Combination Wrench**

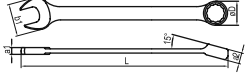
 Krom vanadyum, Krom kaplı  
 Chrom vanadium, Chrom plated

KOD CODE	mm	*	L mm	a1 mm	a2 mm	b1 mm	øD mm	g	TL/ Ad.	
0380 02 0008	8	E10	170	4.5	7.5	20.5	13	40	10	319,00
0380 02 0009	9	E12	180	4.5	8	22.5	14.5	50	10	324,50
0380 02 0010	10	E14	190	5	8.5	24.5	16	60	10	358,75
0380 02 0011	11	E14	200	5.5	9	26.5	17	70	10	379,25
0380 02 0012	12	E16	210	6	9.5	28.5	19	90	10	388,75
0380 02 0013	13	E18	225	6.5	10	30.5	20	100	10	425,75
0380 02 0014	14	E18	235	7	11	32.5	22	120	10	472,00
0380 02 0015	15	E20	250	7.5	12	34.5	23	145	10	498,25
0380 02 0017	17	E22	280	8.5	14	38.5	26.5	195	10	540,50
0380 02 0018	18	E24	295	9	15	40.5	28	210	10	588,25
0380 02 0019	19	E24	310	9.5	16	42.5	29.5	265	10	635,00
0380 02 0022	22	E26	350	11	18	48.5	34.5	400	10	855,00

0380

**Torx® - mm Kombine Anahtar Takımı**  
**Torx® - mm Combination Wrench Set**

**Torx® - mm Kombine Anahtar:** Bir çatal ağız ve bir yıldız ağızdan oluşan anahtarlarımız 8-22 mm arasında boyları bulunmaktadır. Çatal ağız kısmı mevcut çatal anahtarlardan farklı olarak 6 köşe civatanın yanısıra farklı geometrilere sahip civataları açabilmekte ve sıkabilmektedir.

**Torx® - mm combination wrench:** Our wrenches consisting of an open end and a ring end are available in sizes from 8 to 22 mm. Unlike the existing open end wrenches, its open end can unbolt and tighten bolts with different geometries as well as the hexagon bolts.

KOD CODE	İÇERİK CONTENTS	g	TL/ Ad.	
	8 - 9 - 10 - 11 - 12 - 13 - 17 - 19			
0380 00 2108	E10 - E12 - E14 - E14 E16 - E18 - E22 - E24	790	8	3.371,50
	8 - 9 - 10 - 11 - 12 - 13 14 - 15 - 17 - 18 - 19 - 22			
0380 00 2112	E10 - E12 - E14 - E14 - E16 - E18 E18 - E20 - E22 - E24 - E24 - E26	1590	12	5.785,00

0430

### Yıldız İki Ağız Anahtar (mm) Double Ended Ring Wrench (mm)



TS 3794  
TS ISO 10104 Form B  
DIN 838

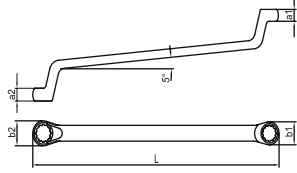

Krom vanadyum, Krom kaplı  
Chrom vanadium, Chrom plated

KOD CODE	mm	L mm	a1 mm	a2 mm	b1 mm	b2 mm	g	TL/Ad.
0430 03 0607	6x7	176	5.6	6	10	11.5	45	10 239,50
0430 03 0809	8x9	190	6.4	6.8	13	14.5	65	10 242,25
0430 03 0810	8x10	190	6.4	7.3	13	15.5	70	10 242,25
0430 03 1011	10x11	206	7.3	7.6	15.5	17	90	10 268,25
0430 03 1012	10x12	206	7.3	8.5	15.5	18.5	100	10 268,25
0430 03 1013	10x13	220	7.3	9	15.5	20	105	10 304,00
0430 03 1113	11x13	220	8.5	9	18.5	20	115	10 304,00
0430 03 1213	12x13	220	8.5	9	18.5	20	115	10 304,00
0430 03 1214	12x14	220	8.5	9.5	18.5	23	120	10 304,00
0430 03 1415	14x15	236	9.5	10	21.5	23	140	10 320,50
0430 03 1317	13x17	250	9	11.5	20	26.5	165	10 362,75
0430 03 1417	14x17	250	9.5	11.5	21.5	26.5	175	10 362,75
0430 03 1617	16x17	250	10.8	11.5	25	26.5	120	10 362,75
0430 03 1618	16x18	260	10.8	12	25	27.5	200	10 430,00
0430 03 1719	17x19	271	11.5	12.5	26.5	29	235	10 430,00
0430 03 1819	18x19	271	12	12.5	27.5	29	240	10 430,00
0430 03 1922	19x22	291	12.5	13.5	29	33	295	5 472,00
0430 03 1924	19x24	311	12.5	14.2	29	36.5	330	5 472,00
0430 03 2022	20x22	291	12.9	13.5	30.5	33	280	5 472,00
0430 03 2123	21x23	311	13.1	14	32	35	360	5 540,50
0430 03 2224	22x24	321	13.5	14.2	33	36.5	360	5 540,50
0430 03 2426	24x26	331	14.2	14.6	36.5	39.5	450	5 629,50
0430 03 2427	24x27	331	14.2	15	36.5	40.5	455	5 629,50
0430 03 2430	24x30	352	14.2	16.7	36.5	45	565	5 688,50
0430 03 2528	25x28	352	14.5	15.5	38	42.5	490	5 688,50
0430 03 2729	27x29	371	15	16.7	40.5	45	610	5 758,25
0430 03 2730	27x30	371	15	16.7	40.5	45	600	5 758,25
0430 03 2732	27x32	371	15	16.7	40.5	47.5	535	5 758,25
0430 03 3032	30x32	371	16.4	16.7	45	47.5	650	5 758,25
0430 03 3036	30x36	402	16.4	17.5	45	53	770	5 1.167,25
0430 03 3236	32x36	402	16.7	17.5	47.5	53	760	5 1.167,25
0430 03 3436	34x36	420	17.1	17.5	50	53	900	5 1.427,00
0430 03 3641	36x41	438	17.5	19.5	53	61	1125	5 1.585,75
0430 03 4146	41x46	485	19.5	20.5	61	67.5	1490	5 2.171,25
0430 03 4650	46x50	535	20.5	22.4	67.5	73.5	1900	5 3.454,25

#### ÖZEL SERİLER (adet ve termin süresi isteyiniz) SPECIAL SERIES (ask for quantity and delivery terms)

0430 03 1014	10x14	220	7.3	9	15.5	21.5	120	10 -
0430 03 1315	13x15	236	9	10	20	23	170	10 -
0430 03 2227	22x27	331	14.2	15	36.5	40.5	500	5 -
0430 03 3034	30x34	379	16.4	16.9	45	50	690	5 -

0430

### Yıldız İki Ağız Anahtar Takımı (mm) Double Ended Ring Wrench Set (mm)



KOD CODE	İÇERİK CONTENTS	g	TL/ Ad.
0430 00 2108	6x7 - 8x9 - 10x11 - 12x13 - 14x15 16x17 - 18x19 - 20x22	1450	8 2.639,25
0430 00 2112	6x7 - 8x9 - 10x11 - 12x13 - 14x15 16x17 - 18x19 - 20x22 - 21x23 24x26 - 25x28 - 27x32	3610	12 5.256,00

0431

 Yıldız İki Ağz Anahtar (SAE)  
 Double Ended Ring Wrench (SAE)

TSEK

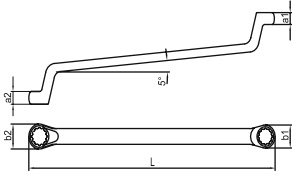
 Krom vanadyum, Krom kaplı  
 Chrom vanadium, Chrom plated

0431

 Yıldız İki Ağz Anahtar Takımı (SAE)  
 Double Ended Ring Wrench, Set (SAE)

TSEK

KOD CODE	inch	L mm	a1 mm	a2 mm	b1 mm	b2 mm	g	TL/ Ad.
0431 03 0608	1/4"x5/16"	176	5.6	6	10	11.5	45	10 295,75
0431 03 0809	5/16"x3/8"	190	6.4	6.8	13	14.5	60	10 306,75
0431 03 0811	5/16"x7/16"	190	6.4	7.3	13	15.5	70	10 320,50
0431 03 0911	3/8"x7/16"	206	7.3	7.6	15.5	17	85	10 338,25
0431 03 1112	7/16"x1/2"	220	8.5	9	18.5	20	120	10 364,00
0431 03 1214	1/2"x9/16"	236	9	10	20	23	135	10 384,50
0431 03 1415	9/16"x19/32"	236	9.5	10	21.5	23	140	10 384,50
0431 03 1416	9/16"x5/8"	236	9.5	10	21.5	24	140	10 388,75
0431 03 1517	19/32"x11/16"	250	10.8	11.5	25	26.5	185	10 434,00
0431 03 1920	3/4"x25/32"	271	12	12.5	27.5	29	230	10 539,25
0431 03 2122	13/16"x7/8"	311	13.1	14	32	35	355	5 647,25
0431 03 2325	15/16"x1"	331	14.2	14.6	36.5	39.5	455	5 755,25
0431 03 2631	11/16"x1 1/4"	371	15	16.7	40.5	48	630	5 908,75
0431 03 2833	11/8"x1 5/16"	371	15	16.7	40.5	48	610	5 908,75
0431 03 3033	1 3/16"x1 5/16"	371	16.4	16.7	45	48	630	5 968,75

 ÖZEL SERİLER (adet ve termin süresi isteyiniz)  
 SPECIAL SERIES (ask for quantity and delivery terms)

0431 03 1217	1/2"x11/16"	250	9	10	20	26.5	185	10 -
0431 03 1417	9/16"x11/16"	250	9.5	11.5	21.5	26.5	185	10 -
0431 03 1617	5/8"x11/16"	250	10.8	11.5	25	26.5	210	10 -
0431 03 1619	5/8"x3/4"	271	11.5	12.5	26.5	29	270	10 -
0431 03 2021	25/32"x13/16"	291	12.9	13.5	30.5	33	270	5 -
0431 03 1922	3/4"x7/8"	291	12.9	13.5	30.5	33	400	5 -
0431 03 2223	7/8"x15/16"	321	13.5	14.2	33	36.5	400	5 -
0431 03 2328	15/16"x1 1/8"	331	14.2	15	36.5	40.5	500	5 -
0431 03 2528	1"x1 1/8"	352	14.5	15.5	38	42.5	570	5 -
0431 03 3036	1 3/16"x1 3/8"	402	16.4	17.5	45	53	880	5 -
0431 03 3236	1 1/4"x1 7/16"	402	16.7	17.5	48	53	890	5 -
0431 03 3641	1 7/16"x1 5/8"	438	17.5	19.5	53	61	1100	5 -
0431 03 4146	1 11/16"x1 7/8"	485	19.5		61	67.5		5 -
0431 03 4650	1 13/16"x2"	535		22.5	67.5	73.5	1955	5 -

KOD CODE	İÇERİK CONTENTS	g	TL/ Ad.
0431 00 2108	1/4"x5/16" - 5/16"x3/8" 7/16"x1/2" - 9/16"x5/8" 19/32"x11/16" 3/4"x25/32" - 13/16"x7/8" 15/16"x1"	1915	8 3.731,00
0431 00 2112	1/4"x5/16" - 5/16"x3/8" 3/8"x7/16" - 7/16"x1/2" 9/16"x5/8" - 19/32"x11/16" 3/4"x25/32" - 13/16"x7/8" 15/16"x1" - 11/16"x1 1/4" 11/8"x1 5/16" 1 3/16"x1 5/16"	3985	12 6.855,50

0440

Düz Yıldız Anahtar (mm)  
Flat Ring Wrench (mm)



TS 3794  
TS ISO 10103  
DIN 837-B

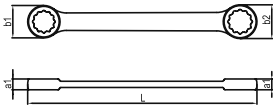

Krom vanadyum, Krom kaplı  
Chrom vanadium, Chrom plated

KOD CODE	mm	L mm	a1 mm	b1 mm	b2 mm	g	TL/ Ad.
0440 03 0607	6x7	99	4.4	9.5	11	15	220,50
0440 03 0809	8x9	113	5.2	12.5	14	20	230,00
0440 03 1011	10x11	125	6	15.5	16.5	25	254,75
0440 03 1213	12x13	140	6.8	18.5	20	40	275,25
0440 03 1415	14x15	156	7.2	21	22.5	55	320,50
0440 03 1617	16x17	170	8	24	25	70	379,25
0440 03 1819	18x19	188	8.8	26.5	27.5	100	395,75
0440 03 2022	20x22	208	9.6	29	32	130	459,75
0440 03 2123	21x23	230	10.6	30	33	160	544,75
0440 03 2426	24x26	256	10.8	35	37.5	220	551,50
0440 03 2528	25x28	280	11.8	36	40.5	265	643,00
0440 03 2732	27x32	310	12.8	38.5	45.5	360	795,00

ÖZEL SERİLER (adet ve termin süresi isteyiniz)  
SPECIAL SERIES (ask for quantity and delivery terms)

0440 03 0810	8x10	120	5.6	12.5	15.5	30	10	-
0440 03 1013	10x13	140	6.8	18.5	20	45	10	-
0440 03 1315	13x15	156	7.2	20	22.5	55	10	-
0440 03 1317	13x17	165	7.8	20.2	25.2	85	10	-
0440 03 1618	16x18	188	8.8	26.5	27.5	90	10	-
0440 03 1719	17x19	188	8.8	26.5	27.5	105	10	-
0440 03 2224	22x24	230	10.8	32	35	170	10	-
0440 03 2427	24x27	256	10.8	35	38.5	225	10	-
0440 03 2729	27x29	290	12.8	38.5	42.5	285	10	-
0440 03 3032	30x32	310	12.8	43	45.5	360	10	-

0440

Düz Yıldız Anahtar Takımı (mm)  
Flat Ring Wrench, Set (mm)



KOD CODE	İÇERİK CONTENTS	g	TL/ Ad.
0440 00 2108	6x7 - 8x9 - 10x11 - 12x13 - 14x15 16x17 - 18x19 - 20x22	560	8 2.535,75
0440 00 2112	6x7 - 8x9 - 10x11 - 12x13 - 14x15 16x17 - 18x19 - 20x22 - 21x23 24x26 - 25x28 - 27x32	1540	12 5.070,00

**0435**

**Süper İzoleli Bir Ağız Yıldız Anahtar (mm)**  
Single Ended Ring Wrench Super Insulated (mm)

± 1000 V  
IEC 60900



**Krom vanadyum, Krom kaplı, Kalın PVC izoleli**  
Chrom vanadium, Chrom plated, Triple PVC insulated

KOD CODE	mm	L mm	g		TL/Ad.
0435 03 0010	10	170	80	10	497,25
0435 03 0011	11	175	85	10	497,25
0435 03 0012	12	180	115	10	564,25
0435 03 0013	13	185	120	10	564,25
0435 03 0014	14	190	135	10	592,75
0435 03 0017	17	205	180	10	671,25
0435 03 0019	19	220	215	10	799,75
0435 03 0022	22	245	310	10	877,25
0435 03 0024	24	270	380	10	1.171,00

**0540**

**Rakor Anahtar (mm)**  
Flare Nut Wrench (mm)

DIN 3118

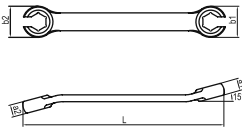

**Krom vanadyum, Krom kaplı**  
Chrom vanadium, Chrom plated

KOD CODE	mm	L mm	a1 mm	a2 mm	b1 mm	b2 mm	g		TL/Ad.
0540 01 0810	8x10	130	7	8.5	18	20	60	10	438,00
0540 01 1011	10x11	150	8.5	9.3	20	22	80	10	455,75
0540 01 1012	10x12	150	8.5	9.3	20	22	75	10	455,75
0540 01 1113	11x13	170	9.3	10.8	22	25.5	105	10	487,25
0540 01 1214	12x14	170	9.3	10.8	22	25.5	100	10	487,25
0540 01 1719	17x19	210	11.8	13	30.5	33.5	190	10	868,75
0540 01 1922	19x22	230	12.8	14.9	33.5	39.5	245	10	1.039,75

**0530**

**Yarım Ay Anahtar Yıldız İki Ağız (mm)**  
Double - Hex Starter and Block Wrench (mm)

TSEK

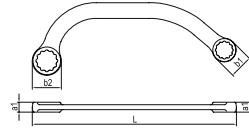

**Krom vanadyum, Krom kaplı**  
Chrom vanadium, Chrom plated

KOD CODE	mm	L mm	a1 mm	b1 mm	b2 mm	g		TL/Ad.
0530 04 0810	8x10	120	6	12.5	15.5	35	10	283,50
0530 04 1011	10x11	150	7	17	20	60	10	332,75
0530 04 1012	10x12	150	7	17	20	60	10	332,75
0530 04 1113	11x13	150	7	17	20	60	10	332,75
0530 04 1315	13x15	185	9	21.5	26	110	10	395,75
0530 04 1317	13x17	185	9	21.5	26	105	10	395,75
0530 04 1417	14x17	185	9	21.5	26	115	10	395,75
0530 04 1517	15x17	185	9	21.5	26	115	10	395,75
0530 04 1922	19x22	230	11	29	33	195	10	513,00

**0531**

**Yarım Ay Anahtar Yıldız İki Ağız (SAE)**  
Double - Hex Starter and Block Wrench (SAE)

TSEK

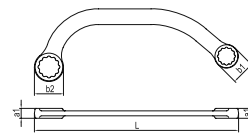

**Krom vanadyum, Krom kaplı**  
Chrom vanadium, Chrom plated

KOD CODE	inch	L mm	a1 mm	b1 mm	b2 mm	g		TL/Ad.
0531 04 1112	7/16"x1/2"	150	7	17	20	60	10	409,50
0531 04 1214	1/2"x9/16"	185	9	21.5	26	110	10	476,25
0531 04 1416	9/16"x5/8"	185	9	21.5	26	110	10	490,00
0531 04 1922	3/4"x7/8"	230	11	29	33	195	10	617,25

**ÖZEL SERİLER (adet ve termin süresi isteyiniz)**  
**SPECIAL SERIES (ask for quantity and delivery terms)**

0531 04 0809	5/16"x3/8"	120	6	12.5	15.5	30	10	-
0531 04 0911	3/8"x7/16"	150	7	17	20	50	10	-
0531 04 1417	9/16"x11/16"	185	9	21.5	26	110	10	-

0700

### Çatal Çakma Anahtar (mm) Slugging Open Jaw Wrench (mm)

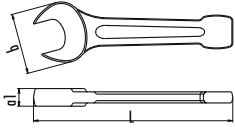
TS 81  
DIN 133Krom vanadyum  
Chrom vanadium

KOD CODE	mm	L mm	a1 mm	b mm	g		TL/Ad.
0700 05 0024	24	160	14	50	280	1	569,25
0700 05 0027	27	180	15	55	385	1	706,00
0700 05 0030	30	190	16	64	525	1	867,75
0700 05 0032	32	190	16	64	530	1	972,75
0700 05 0036	36	210	18	75	755	1	1.092,00
0700 05 0038	38	210	18	75	760	1	1.314,75
0700 05 0041	41	230	18	85	920	1	1.428,50
0700 05 0042	42	230	18	85	930	1	1.650,00
0700 05 0046	46	255	20	95	1350	1	1.815,50
0700 05 0047	47	255	20	95	1320	1	2.120,50
0700 05 0050	50	275	20	105	1550	1	2.268,50
0700 05 0055	55	310	23	119	2305	1	3.040,00
0700 05 0060	60	310	23	119	2210	1	3.299,75
0700 05 0065	65	340	28	135	3300	1	4.746,00
0700 05 0070	70	375	31	154	4555	1	6.074,00
0700 05 0075	75	375	31	154	4460	1	6.436,50
0700 05 0080	80	405	34	169	6115	1	8.183,50
0700 05 0085	85	405	34	169	5740	1	10.848,25
0700 05 0090	90	445	38	189	8040	1	11.163,00
0700 05 0095	95	445	38	189	8160	1	11.904,50
0700 05 0100	100	485	44	214	11850	1	16.871,75
0700 05 0105	105	485	44	214	11785	1	17.397,00
0700 05 0110	110	510	50	234	15000	1	19.849,75
0700 05 0115	115	510	50	234	14830	1	22.802,00
0700 05 0120	120	543	54	254	18865	1	24.069,00

#### ÖZEL SERİLER (adet ve termin süresi isteyiniz) SPECIAL SERIES (ask for quantity and delivery terms)

0700 05 0125	125	543	54	254	17250	1	-
0700 05 0130	130	560	56	275	20000	1	-
0700 05 0135	135	560	56	275	19700	1	-
0700 05 0140	140	630	58.5	310	19400	1	-
0700 05 0145	145	630	58.5	310	28000	1	-
0700 05 0150	150	630	58.5	310	27600	1	-

0750

### Yıldız Çakma Anahtar (mm) Slugging Ring Wrench (mm)

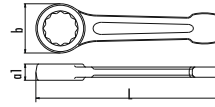
TS 3794  
DIN 7444Krom vanadyum  
Chrom vanadium

KOD CODE	mm	L mm	a1 mm	b mm	g		TL/Ad.
0750 05 0024	24	160	15	41.5	230	1	797,75
0750 05 0027	27	180	16	45.5	300	1	952,25
0750 05 0030	30	190	17	51	435	1	1.134,50
0750 05 0032	32	190	17	51	410	1	1.304,00
0750 05 0036	36	205	19	58	550	1	1.476,50
0750 05 0038	38	205	19	58	530	1	1.767,75
0750 05 0041	41	225	20	63	730	1	1.929,00
0750 05 0042	42	225	20	63	700	1	2.205,50
0750 05 0046	46	240	22	71	970	1	2.305,25
0750 05 0047	47	240	22	71	930	1	2.544,50
0750 05 0050	50	255	23	77	1160	1	2.722,50
0750 05 0055	55	272	25	88	1520	1	3.829,50
0750 05 0060	60	272	25	88	1460	1	4.153,50
0750 05 0065	65	300	28	98	2025	1	5.430,00
0750 05 0070	70	330	32	108	2890	1	6.216,50
0750 05 0075	75	330	32	108	2755	1	6.654,25
0750 05 0080	80	360	35	126	4000	1	9.450,50
0750 05 0085	85	360	35	126	3620	1	10.632,25
0750 05 0090	90	390	40	140	5465	1	13.078,25
0750 05 0095	95	390	40	140	5250	1	14.746,00
0750 05 0100	100	420	44	148	6755	1	17.046,75
0750 05 0105	105	420	44	148	6445	1	17.597,00
0750 05 0110	110	450	48	166	8500	1	18.811,50
0750 05 0115	115	450	48	166	8460	1	21.085,25
0750 05 0120	120	490	54	178	11425	1	28.980,00

#### ÖZEL SERİLER (adet ve termin süresi isteyiniz) SPECIAL SERIES (ask for quantity and delivery terms)

0750 05 0125	125	490	54	178	9900	1	-
0750 05 0130	130	518	59	196	16000	1	-
0750 05 0135	135	518	59	196	15900	1	-
0750 05 0140	140	518	59	196	15800	1	-
0750 05 0145	145	580	61.8	223	22000	1	-
0750 05 0150	150	580	61.8	223	21900	1	-
0750 05 0155	155	580	61.8	223	21800	1	-
0750 05 0160	160	580	61.8	223	21700	1	-
0750 05 0165	165	648	67	262	30000	1	-
0750 05 0170	170	648	67	262	29800	1	-
0750 05 0180	180	648	67	262	29700	1	-

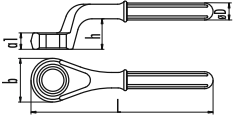
**0550**
**Boru Uzatmalı Yıldız Anahtar (mm)**  
 Offset Ring Wrench (mm)

**Krom vanadyum, Krom kaplı**  
 Chrom vanadium, Chrom plated

KOD CODE	mm	L mm	a1 mm	b mm	σD mm	h mm	g		TL/Ad.
0550 05 0024	24	180	17	37	18.5	30	400	1	833,50
0550 05 0027	27	190	18	42	18.5	33	460	1	993,25
0550 05 0030	30	200	20	46	18.5	34	530	1	1.186,25
0550 05 0032	32	235	21.5	49	21.2	37	740	1	1.361,25
0550 05 0036	36	245	23	53.5	21.2	42	830	1	1.539,00
0550 05 0038	38	270	25	60.5	21.2	43	965	1	1.776,00
0550 05 0041	41	270	25	60.5	21.2	43	950	1	2.012,50
0550 05 0046	46	280	26	68	24.2	45	1270	1	2.406,75
0550 05 0050	50	290	28	74	24.2	47	1420	1	2.841,50
0550 05 0055	55	300	30	79	24.2	50	1590	1	3.994,75
0550 05 0060	60	345	32	89	29	50.5	2390	1	4.335,50
0550 05 0065	65	355	34	98	29	56.5	2790	1	4.695,25

**ÖZEL SERİLER (adet ve termin süresi isteyiniz)**  
**SPECIAL SERIES (ask for quantity and delivery terms)**

0550 05 0022	22	180	17	37	18.5	30	400	1	--
0550 05 0034	34	235	21.5	49	21.2	37	750	1	-
0550 05 0070	70	365	37	104	29	55	2900	1	-
0550 05 0075	75	375	40	109	29	57.5	3100	1	-
0550 05 0080	80	385	43	124	29	59	3900	1	-
0550 05 0085	85	385	43	124	29	59	3750	1	-
0550 05 0090	90	410	46	140	29	63	5100	1	-
0550 05 0095	95	410	46	140	29	63	4950	1	-
0550 05 0100	100	420	46	150	29	65	4800	1	-

**0551**
**Döndürme Kolu Borusu**  
 Tubular Handle

**Dikişsiz Çelik Boru**  
 Seamless Steel Pipe

KOD CODE	mm	L mm	σ mm	g		TL/Ad.
0551 05 0001	22 - 30	460	25	730	1	780,00
0551 05 0002	32 - 41	610	27	935	1	1.056,25
0551 05 0003	46 - 55	760	32.2	1910	1	1.581,50
0551 05 0004	60 - 100	860	38	2865	1	2.134,25

**0600**
**Kurbağacık Anahtar**  
 Adjustable Wrench



 Yedek parça sayfa 255-259  
 Spare parts page 255-259

İZELTAS YOUTUBE

**Krom vanadyum, Krom kaplı, PVC izoleli**  
 Chrom vanadium, Chrom plated, PVC insulated

KOD CODE	L mm	L inch	mm	g		TL/Ad.
0600 01 1006	160	6"	19	140	5	766,25
0600 01 1008	208	8"	24	245	5	957,75
0600 01 1010	260	10"	27	410	5	1.234,25
0600 01 1012	308	12"	34	695	5	1.706,25
0600 01 1015	388	15"	41	1555	1	2.672,00

**0600 01 0010**
**1000V İzoleli Kurbağacık Anahtar**  
 Insulated Electrician Type Adjustable  
 Wrench 1000V

 TS ISO 6787  
 ⚡ 1000 V  
 EC 60900

 Yedek parça sayfa 255-259  
 Spare parts page 255-259

**Krom vanadyum, Krom kaplı, Kalın PVC izoleli**  
 Chrom vanadium, Chrom plated, Triple PVC insulated

KOD CODE	L mm	L inch	mm	g		TL/Ad.
0600 01 0010	260	10"	27	475	5	1.798,00



0860

Kanca Anahtar (dörtgen uçlu)  
Hook Wrench

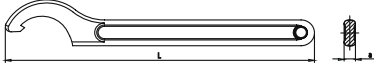
TS 3798  
DIN 1810



Krom vanadyum, Krom kaplı  
Chrom vanadium, Chrom plated

KOD CODE	 mm	L mm	a1 mm	 g		TL/Ad.
0860 05 2528	25/28	136	4	50	10	409,50
0860 05 3032	30/32	136	4	50	10	409,50
0860 05 3436	34/36	171	5	95	10	442,25
0860 05 4042	40/42	171	5	90	10	442,25
0860 05 4550	45/50	210	6	165	10	512,00
0860 05 5255	52/55	210	6	160	10	512,00
0860 05 5862	58/62	242	7	270	5	617,25
0860 05 6875	68/75	242	7	265	5	617,25
0860 05 8090	80/90	281	8	415	5	806,00
0860 05 9510	95/100	281	8	405	5	806,00



# LOKMA VE BİJON ANAHTARLARI

## SOCKET AND RIM WRENCHES

- Lokma Anahtarlar  
Socket Wrenches
- Lokma Takımları  
Socket Wrench Sets
- Kovan Anahtarlar  
Tubular Socket Wrenches
- Bijon Anahtarlar  
Rim Wrenches
- Tork Anahtarları  
Torque Wrenches



## TORK ANAHTARLARI HAKKINDA / ABOUT TORQUE WRENCHES

### Tork (Moment) ve Kuvvet / Torque (Moment) and Force

Kuvvetin bir cisme hareket veren etki olduğunu biliyorsunuz. Tork ise bir cismin kuvvet etkisi altında dönmesidir. Yıldız tornavida, anahtar veya lokma anahtar gibi çeşitli el aletleri, bağlantı elemanlarını sıkma için kullanılır. Bu işlem işlevsel ve doğru görünse de, dişli bağlantının güvenilirliği için uygun bir prosedür değildir. Dişli bir bağlantının gevşemeye karşı en büyük güvenliği, önceden teorik olarak hesaplanmış belirli bir tork seviyesinde sıkılmasıdır. Bu ancak çeşitli modern yöntemlerle sağlanabilir. Örneğin, tork anahtarı ile sıkma, motor tahrikli sıkma veya ultrason destekli sıkma. Çeşitli uygulamalar, tork anahtarı kullanımının daha uygun olduğunu göstermiştir.



As you know, force is the effect which imparts movement to an object. Torque, is rotation of an object under effect of force. Various hand tools like a phillips head screwdriver, for spanner or socket wrench are used to tighten connection elements. While this process appears functional and correct, it is not an appropriate procedure for reliability of the threaded connection. The greatest safety of a threaded connection against loosening is being tightened at a certain torque level theoretically calculated beforehand. This can only be ensured with various modern methods. For example, tightening with a torque wrench, motor-driven tightening or ultrasound supported tightening. Various applications have shown that use of a torque wrench is more appropriate.

### Sıkma Torku Nedir? / What is Tightening Torque?

Sıkma torku, dönen kolun ucunda, kuvvet etkisiyle anahtarın ucunda oluşur ve birimi Nm'dir. Bu sıkma torku, dişli bağlantı üzerinde bir ön gerilme oluşturur. Sıkma torkunun gerekenden düşük olması, zamanla oluşabilecek titreşimler nedeniyle dişli bağlantının gevşemesine veya çözülmesine neden olabilir. Öte yandan, ön gerilme kuvvetinin gerekenden fazla olması, bağlantı parçalarında hasara yol açabileceği gibi, bağlantı parçasındaki dişlerin aşınmasına veya bağlantının ayrılmaz hale gelmesine de neden olabilir.

Tightening torque is generated at the wrench tip at the terminus of the rotating lever under the effect of force, and its unit is Nm. This tightening torque creates a pretension on the threaded connection. Tightening torque being lower than what is necessary can cause the threaded connection to loosen/unravel due to vibrations that might occur over time. On the other hand, pre-tension force being over what is necessary can cause damage on the connection parts, as well as causing the threads on the connection piece to wear off or causing the connection become non-severable.

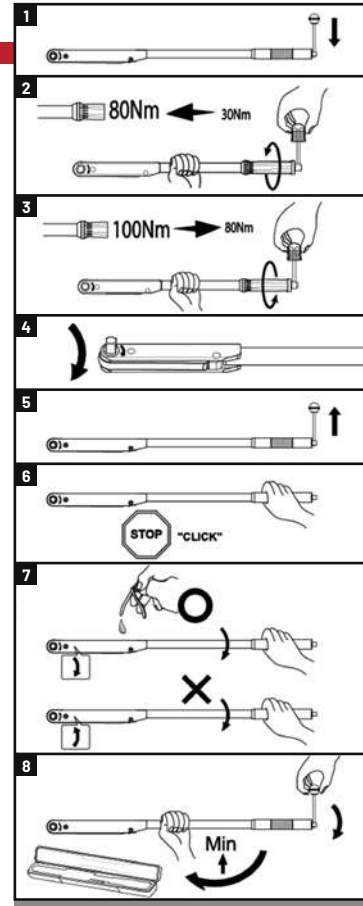

## TORK ANAHTARLARI HAKKINDA / ABOUT TORQUE WRENCHES

### Tork Anahtarlarının Doğru Kullanımı Correct Use Of Torque Wrenches

Hangi tork anahtarı tipi kullanılırsa kullanılsın, dönme yönünün tersine kuvvet uygulanmamalıdır.

- Cırcırlı anahtarlar gibi tork anahtarları, bağlantıları gevşetmek için kullanılmamalıdır.
- "Klik" ses seçeneği olan modellerde, klik sesi ayarlanan tork değerine ulaşıldığını gösterir ve bu andan itibaren daha fazla kuvvet uygulanmamalıdır.
- Gövdesi veya mekanizması hasar görmüş tork anahtarları kullanılmaya devam edilmemelidir.
- Kuvvet, tork anahtarının sap kısmına uygulanmalıdır.
- Nem ve kirden korumak için alet, kullanımdan sonra her zaman kutusunda saklanmalıdır.
- Tork anahtarının yük ayarı, her kullanımdan sonra "0 Nm" konumuna getirilmelidir.
- Lütfen tork anahtarlarını kendi başınıza tamir etmeye çalışmayın.

There are some important points that must be kept in mind when working with a torque wrench. Some of these include the following.

- No matter which type of torque wrench is used, force should not be applied at the opposite of rotating direction.
- Torque wrenches like ratchet wrenches should not be used to loosen connections.
- In models with click sound option, the click indicates the set torque value is achieved and further force should not be applied from then on.
- Do not continue using torque wrenches with a damaged body or mechanism.
- Force should be applied at the handle part of the torque wrench.
- The tool should always be kept in its box after use to protect against moisture and dirt.
- The load set of the torque wrench should be adjusted to "0 Nm" after each use.
- Please do not attempt to repair torque wrenches on your own.



### Tork Anahtarlarının Kalibrasyonu Calibration Of Torque Wrenches

Kalibrasyon süreci, tork anahtarlarının doğru çalışması ve bağlantıları sağlıklı bir şekilde sıkabilmesi için büyük önem taşır. TS EN ISO 6789-1 Standardı, tork anahtarlarının ilk kullanımdan itibaren 12 aylık periyotlarla veya her 5000 kullanımdan sonra kalibre edilmesi gerektiğini şart koşar.

Calibration process carries great importance for torque wrenches to function correctly and be able to tighten connections in a healthy fashion. TS EN ISO 6789-1 Standard stipulates torque wrenches should be calibrated with 12 month periods or after each cycle of 5000 uses starting from the first use.

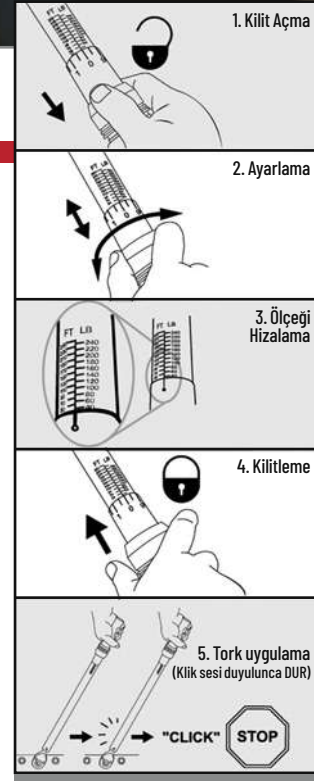



**Nikel üzeri krom kaplama ile korozyon direncinde üst seviye koruma**  
Corrosion protection with nickel over chrome plating

**Yüksek dayanım için üst toleranslarda tasarım**  
Improved durability with upper tolerance thickness

**En uygun temas yüzeyi için hassas dövülmüş altı köşe ağızlar**  
Precise forged hex shape for best contact area



**Bilya stoplama yuvalı hassas işlenmiş kare kanal**  
Precise machined square adapter with ball stopper Groove

**Yüksek mukavemetli alaşımli sıcak dövme çeliği**  
High strength alloyed forged steel

**Extra sürtünme kabiliyeti için tırtıklı tasarım**  
Extra friction capability with knurled design



İZELTAS USTA İŞİ  
SOHBETLER



İZELTAS YOUTUBE

1107

**1/4" Altı Köşe Lokma Anahtar (mm)**  
 Socket Wrench 6 Points (mm)

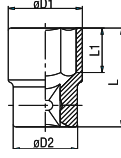
 TS ISO 2725 -1  
 DIN 3124

1/4"

 Krom vanadyum, Krom kaplı  
 Chrom vanadium, Chrom plated

KOD CODE	mm	ø D1 mm	ø D2 mm	L mm	L1 mm	g	TL/ Ad.
1107 06 0004	4	6.8	11.8	25	4	10	45,50
1107 06 0045	4.5	7.4	11.8	25	5	10	45,50
1107 06 0005	5	8	11.8	25	6	10	45,50
1107 06 0055	5.5	8.5	11.8	25	6	10	45,50
1107 06 0006	6	9.2	11.8	25	7	10	45,50
1107 06 0007	7	10.8	11.8	25	7	10	45,50
1107 06 0008	8	11.9	11.8	25	8	10	45,50
1107 06 0009	9	12.9	12.8	25	8	10	48,00
1107 06 0010	10	14.3	14.3	25	9	20	48,00
1107 06 0011	11	15.8	15.8	25	9	25	60,50
1107 06 0012	12	16.8	16.8	25	9	30	60,50
1107 06 0013	13	17.8	17.8	25	9	30	70,00

1107

**1/4" Altı Köşe Derin Lokma Anahtar (mm)**  
 Deep Socket Wrench 6 Points (mm)

TS ISO 2725 -1

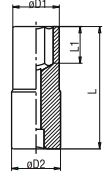

1/4"

 Krom vanadyum, Krom kaplı  
 Chrom vanadium, Chrom Plated

KOD CODE	mm	ø D1 mm	ø D2 mm	L mm	L1 mm	g	TL/ Ad.
1107 06 4004	4	6.8	11.8	50	6	20	85,00
1107 06 4005	5	8	11.8	50	7	20	85,00
1107 06 4055	5.5	8.7	11.8	50	9	20	85,00
1107 06 4006	6	9.2	11.8	50	9	20	96,00
1107 06 4007	7	10.8	11.8	50	15	25	96,00
1107 06 4008	8	11.8	11.8	50	15	25	96,00
1107 06 4009	9	13	13	50	15	30	102,75
1107 06 4010	10	14.5	14.5	50	15	40	102,75
1107 06 4011	11	15.8	15.8	50	21	45	109,50
1107 06 4012	12	16.8	16.8	50	21	50	109,50
1107 06 4013	13	17.8	17.8	50	21	55	109,50

1107 00 6014

**1/4" Altı Köşe Derin Lokma Anahtar Set (14 parça, mm)**  
 Deep Socket Wrench Set Type 6 Points (14 pcs, mm)

1/4"

KOD CODE	LOKMA LAR Sockets	AVADANLIKLAR Accessories	g	TL/Ad.
1107 00 6014	4-5-5,5-6 7-8-9-10 11-12-13 Altı Köşe Derin Lokma Wrench 6 Points	1/4" Cırcır Kol Ratchet Handle  1/4" Ara Kol Extension Bar 50 mm  1/4" Ara Kol Extension Bar 100 mm	805	14 2.099,75



Havalı aletler ile kullanmayınız / Do not use with power-tools

1107

### 1/4" Lokmalı Allen Uç

Hexagonal Bit Socket Wrench



1/4"

Krom vanadyum, Krom Kaplı  
Chrom vanadium, Chrom Plated

KOD CODE	mm	L mm	g	□	TL/ Ad.
1107 06 1125	2.5	37	15	10	75,25
1107 06 1103	3	37	15	10	75,25
1107 06 1104	4	37	15	10	75,25
1107 06 1105	5	37	15	10	75,25
1107 06 1106	6	37	15	10	75,25
1107 06 1107	7	37	20	10	89,00
1107 06 1108	8	37	20	10	89,00
1107 06 1110	10	37	25	10	105,50

1107

### 1/4" Lokmalı Star Delikli (Torx®) Uç

Tamper Resistant Torx® Bit Socket Wrench



1/4"

Krom vanadyum, Krom Kaplı  
Chrom vanadium, Chrom Plated

KOD CODE	mm	L mm	g	□	TL/ Ad.
1107 06 1308	TR8	37	15	10	90,50
1107 06 1309	TR9	37	15	10	90,50
1107 06 1310	TR10	37	15	10	90,50
1107 06 1315	TR15	37	15	10	90,50
1107 06 1320	TR20	37	15	10	90,50
1107 06 1325	TR25	37	15	10	90,50
1107 06 1327	TR27	37	15	10	90,50
1107 06 1330	TR30	37	15	10	90,50
1107 06 1340	TR40	37	15	10	104,25

1107

### 1/4" Lokmalı Star (Torx®) Uç

Torx® Bit Socket Wrench



1/4"

Krom vanadyum, Krom Kaplı  
Chrom vanadium, Chrom Plated

KOD CODE	mm	L mm	g	□	TL/ Ad.
1107 06 1208	T8	37	15	10	78,25
1107 06 1209	T9	37	15	10	78,25
1107 06 1210	T10	37	15	10	78,25
1107 06 1215	T15	37	15	10	78,25
1107 06 1220	T20	37	15	10	78,25
1107 06 1225	T25	37	15	10	78,25
1107 06 1227	T27	37	15	10	78,25
1107 06 1230	T30	37	15	10	78,25
1107 06 1240	T40	37	15	10	78,25

1107

### 1/4" Lokmalı Düz Uç

Slotted Bit Socket Wrench



1/4"

Krom vanadyum, Krom Kaplı  
Chrom vanadium, Chrom Plated

KOD CODE	mm	L mm	g	□	TL/ Ad.
1107 06 1403	3	37	15	10	75,25
1107 06 1435	3.5	37	15	10	75,25
1107 06 1404	4	37	15	10	75,25
1107 06 1445	4.5	37	15	10	75,25
1107 06 1455	5.5	37	15	10	75,25
1107 06 1465	6.5	37	15	10	75,25
1107 06 1407	7	37	15	10	75,25
1107 06 1408	8	37	15	10	97,25
1107 06 1410	10	37	20	10	104,25

Havali aletler ile kullanmayınız / Do not use with power-tools

**1107**
**1/4" Lokmalı Yıldız Uç**  
 Phillips Bit Socket Wrench

**1/4"**

 Krom vanadyum, Krom Kaplı  
 Chrom vanadium, Chrom Plated

KOD CODE	+	L mm	g	□	TL/Ad.
1107 06 1501	Ph 1	37	15	10	75,25
1107 06 1502	Ph 2	37	15	10	75,25
1107 06 1503	Ph 3	37	15	10	75,25
1107 06 1504	Ph 4	37	15	10	75,25

**1107 00 1042**
**1/4" Bits Uçlu Lokma Set (42 Parça)**  
 Bit Socket Wrench Set (42 Pcs)

**1/4"**

KOD CODE	İÇERİK CONTENTS	□	TL/Ad.
1107 00 1042	1/4" Lokmalı Star Torx® Uçlar Torx® Bit Socket T8-T9-T10-T15-T20-T25-T27-T30-T40	42	4.367,25
	1/4" Lokmalı Star Delikli Torx® Uçlar Tamper Resistant Torx® Bit Socket Wrench TR8-TR9-TR10-TR15-TR20-TR25-TR27 TR30-TR40		
	1/4" Lokmalı Allen Uçlar Hexagonal Bit Socket Wrench 2.5-3-4-5-6-7-8-10		
	1/4" Lokmalı Düz Uç Slotted Bit Socket Wrench 3-3.5-4-4.5-5.5 6.5-7-8-10		
	1/4" Lokmalı Yıldız Uç Phillips Bit Socket Wrench Ph1-Ph2-Ph3-Ph4		
	1/4" Cırcir kolu Ratchet Handle		
	1/4" Ara Kol Extension Bar 100 mm		
1/4" Lokma Tornavida Adaptörü Spindle Handle			

**1507**
**1/4" Ara Kol**  
 Extension Bar

 TS ISO 1174-1  
 TS ISO 3316  
 DIN 3123

**1/4"**

 Krom vanadyum, Krom kaplı  
 Chrom vanadium, Chrom plated

KOD CODE	L mm	g	□	TL/Ad.
1507 06 0050	50	20	5	112,50
1507 06 0100	100	40	5	120,75

**1507 06 3150**
**1/4" Ara Kol Flexible**  
 Flexible Extension

**1/4"**

 Krom vanadyum, Krom kaplı  
 Chrom vanadium, Chrom plated

KOD CODE	L mm	g	□	TL/Ad.
1507 06 3150	150	20	5	488,50

**1507 06 0038**
**1/4" Mafsal**  
 Universal Joint

 TS ISO 1174-1  
 DIN 3123

**1/4"**

 Krom vanadyum, Krom kaplı  
 Chrom vanadium, Chrom plated

KOD CODE	L mm	g	□	TL/Ad.
1507 06 0038	38	38	5	204,25

**1507 06 4115**
**1/4" T Kol**  
 Sliding T - Handle

 TS ISO 3315  
 DIN 3122

**1/4"**

 Krom vanadyum, Krom kaplı  
 Chrom vanadium, Chrom plated

KOD CODE	L mm	g	□	TL/Ad.
1507 06 4115	115	110	5	200,00

1507 06 2140

1/4" Cırcır Kolu (45 Diş)  
Ratchet Handle (45 Teeth)

TS ISO 3315



1/4"

Krom vanadyum, Krom kaplı  
Chrom vanadium, Chrom plated

KOD CODE	L mm	g		TL/Ad.
1507 06 2140	140	115	5	789,50

1507 06 6140

1/4" Mandallı Cırcır Kolu (24 Diş)  
Ratchet With Latch (24 Teeth)

TS ISO 3315



1/4"

Krom vanadyum, Krom kaplı  
Chrom vanadium, Chrom plated

KOD CODE	L mm	g		TL/Ad.
1507 06 6140	140	115	5	1.130,25

1507 06 7115

1/4" Mafsallı T Kol Cırcır Kolu (72 Diş)  
Swivel Head, T Handle Ratchet (72 Teeth)

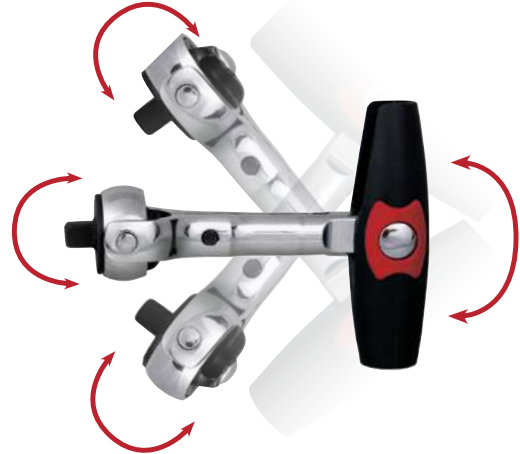

1/4"

Krom vanadyum, Krom kaplı  
Chrom vanadium, Chrom plated

KOD CODE	L mm	g		TL/Ad.
★ 1507 06 7115	115	120	5	2.514,75

★ Stoklarla sınırlıdır / It is limited by stocks

Havallı aletler ile kullanmayınız / Do not use with power-tools

**1507 06 0004**
**1/4" Lokma Adaptörü**  
 Adapter

 TS ISO 3316  
 DIN 3123

**1/4"**

 Krom vanadyum, Krom kaplı  
 Chrom vanadium, Chrom plated

KOD CODE	inch	g		TL/Ad.
1507 06 0004	1/4"Fx3/8"M	15	5	102,75

**1507 06 4080**
**1/4" Derin Lokma Tornavida Adaptörü**  
 Spindle Handle

 TS ISO 3315  
 DIN 3122

**1/4"**

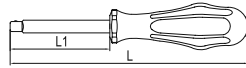
 Krom vanadyum, Krom kaplı, Selüloz Asetat Saplı  
 Chrom vanadium, Chrom plated, Cellulose Acetate Handle

KOD CODE	L mm	L1 mm	g		TL/Ad.
1507 06 4080	150	65	100	10	235,50

**1107 06 5010**
**1/4" Bits Tutucu Lokma (Mıknatıslı)**  
 Bit Holder Socket

**1/4"**

 Krom vanadyum  
 Chrom vanadium

KOD CODE	Inch	g		TL/Ad.
1107 06 5010	1/4" F - 1/4" F	60	5	164,25

**1107 00 6015**
**1/4" Altı Köşe Lokma Anahtar Takımı (15 parça, mm)**  
 Socket Wrench Set 6 Points (15 pcs, mm)

**1/4"**

KOD CODE	LOKMALAR Sockets	AVADANLIKLAR Accessories	g		TL/Ad.
1107 00 6015		1/4" Cırcır kolu Ratchet Handle	685	15	1.941,50
	4 - 5 - 6	1/4" Mafsal Universal Joint			
	7 - 8 - 9 - 10	1/4" T Kol Sliding T Handle			
	11 - 12 - 13	1/4" Ara Kol Extension Bar 50 mm			
	Altı Köşe Six Points	1/4" Ara Kol Extension Bar 100 mm			



Havalı aletler ile kullanmayınız / Do not use with power-tools

14000 005131

### 1/4" Altı Köşe Lokma Anahtar ve Bits Set (48 parça, mm)

Socket Wrench 6 Points and Bits Set (48 Pcs, mm)



1/4"

KOD CODE	LOKMALAR Sockets	AVADANLIKLAR Accessories	g	TL/Ad.
14000 005131	4 - 4.5 - 5 5.5 - 6 - 7 - 8 9 - 10 - 11 - 12 13 - 14 Altı Köşe Lokma Anahtar Six Points	1/4" Cırcır kolu Ratchet Handle 1/4" Mafsal Universal Joint 1/4" Ara Kol Extension Bar 50 -100 mm 1/4" Bits Tutucu Lokma Bits Holder Socket 1/4" Derin Lokma Tornavida Adaptörü Spindle Handle	1450 48	5.120,75
	4 - 4.5 - 5 5.5 - 6 - 7 - 8 9 - 10 - 11 - 12 13 - 14 Altı Köşe Derin Lokma Anahtar Six Points Deep	SL3 - SL4,5 - SL5 SL6.5 - SL8 PH0 - PH1 - PH2 PH3 H3 - H4 - H5 - H6 H7 - H8 - H10		

14000 005132

### 1/4" Altı Köşe Lokma Anahtar ve Bits Set (27 parça, mm)

Socket Wrench 6 Points and Bits Set (27 Pcs, mm)



1/4"

KOD CODE	LOKMALAR Sockets	AVADANLIKLAR Accessories	g	TL/Ad.
14000 005132	4 - 4.5 - 5 5.5 - 6 - 7 - 8 9 - 10 - 12 13 - 14 Altı Köşe Lokma Anahtar Six Points	1/4" Cırcır Kolu Ratchet Handle 1/4" Mafsal Universal Joint 1/4" Ara Kol Extension Bar 100 mm 1/4" Bits Tutucu Lokma Bits Holder Socket	575 27	2.231,50
		PH1 - PH2 H3 - H4 - H5 T10 - T15 - T20 T25 - T30 - T40		

14000 005133

### 1/4" Altı Köşe Lokma Anahtar ve Bits Set (45 parça, mm)

Socket Wrench 6 Points and Bits Set (45 Pcs, mm)



1/4"

KOD CODE	LOKMALAR Sockets	AVADANLIKLAR Accessories	g	TL/Ad.
14000 005133	4 - 5 5.5 - 6 - 7 - 8 9 - 10 - 11 - 12 13 - 14 Altı Köşe Lokma Anahtar Six Points	1/4" Cırcır kolu Ratchet Handle 1/4" Mafsal Universal Joint 1/4" Ara Kol Extension Bar 50 mm 1/4" Bits Tutucu Lokma Bits Holder Socket 1/4" Derin Lokma Tornavida Adaptörü Spindle Handle 1/4" Arakol Flexible Flexible Extension	1020 45	3.275,25
		SL4.5 - SL6.5 SL7 - SL8 PH1 - PH2 - PH3 PZ1 - PZ2 - PZ3 H2.5 - H3 - H4 - H5 H6 - H7 - H8 - H10 T8U - T9U - T10U T15U - T20U - T25U T27U - T30U - T40U		

Havali aletler ile kullanmayınız / Do not use with power-tools

1110

**3/8" Altı Köşe Lokma Anahtar (mm)**  
 Socket Wrench 6 Points (mm)

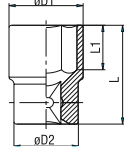
 TS ISO 2725 - 1  
 DIN 3124

**3/8"**

 Krom vanadyum, Krom kaplı  
 Chrom vanadium, Chrom plated

KOD CODE	mm	ø D1 mm	ø D2 mm	L mm	L1 mm	g	TL/Ad.
1110 06 0006	6	9.8	17.8	27	9	20	113,75
1110 06 0007	7	10.8	17.8	27	9	20	113,75
1110 06 0008	8	12	17.8	27	9	25	113,75
1110 06 0009	9	13.2	17.8	27	9	25	113,75
1110 06 0010	10	14.5	17.8	27	9	25	113,75
1110 06 0011	11	15.8	17.8	27	9	25	113,75
1110 06 0012	12	16.8	17.8	27	9	25	113,75
1110 06 0013	13	17.8	16.8	27	9	25	120,75
1110 06 0014	14	19.6	17.5	29	11	30	120,75
1110 06 0015	15	20.8	18	29	11	35	120,75
1110 06 0016	16	21.8	19	29	11	35	126,00
1110 06 0017	17	23.4	20	29	11	50	126,00
1110 06 0018	18	24.7	21	29	13	50	131,50
1110 06 0019	19	25.8	22	29	13	60	150,50
1110 06 0021	21	27.8	24	32	13	70	170,00
1110 06 0022	22	29.7	26	32	15	85	182,25
1110 06 0023	23	29.7	26	32	15	85	182,25

1110 06 9208

**3/8" Buji Lokma Anahtar (Lastikli)**  
 Spark Plug Socket with Rubber

**3/8"**

 Krom vanadyum, Krom kaplı  
 Chrom vanadium, Chrom plated

KOD CODE	mm	L mm	g	TL/Ad.
1110 06 9208	20.8	65	155	10 241,00

Havali aletler ile kullanmayınız / Do not use with power-tools

**3/8" Altı Köşe Derin Lokma Anahtar (mm)**  
 Deep Socket Wrench 6 Points (mm)

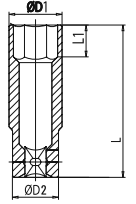
 TS ISO 2725 - 1  
 DIN 3124

**3/8"**

 Krom vanadyum, Krom kaplı  
 Chrom vanadium, Chrom plated

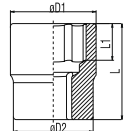
KOD CODE	mm	ø D1 mm	ø D2 mm	L mm	L1 mm	g	TL/Ad.
14000 004965	6	9.9	17.8	63	10	50	211,00
14000 004966	7	10.8	17.8	63	12	55	211,00
14000 004967	8	12	17.8	63	12	55	211,00
14000 004968	9	13.2	17.8	63	12	55	211,00
14000 004969	10	14.5	17.8	63	12	60	211,00
14000 004970	11	15.8	17.8	63	15	60	211,00
14000 004971	12	16.8	17.8	63	15	60	211,00
14000 004972	13	17.8	16.8	63	15	60	217,75
14000 004973	14	19.7	18	63	16	70	217,75
14000 004974	15	20.8	18	63	18	70	217,75
14000 004975	16	21.8	19	63	18	80	217,75
14000 004976	17	23.8	20	63	18	90	291,75
14000 004977	18	24.7	21	63	20	105	291,75
14000 004978	19	25.8	21	63	20	110	298,50
14000 004980	21	27.8	25	63	20	130	341,00
14000 004981	22	29.7	26	63	20	165	402,50

**3/8" Star (Torx®) Lokma Anahtar**  
 Star Torx® Socket Wrench

**3/8"**

 Krom vanadyum, Krom kaplı  
 Chrom vanadium, Chrom plated

KOD CODE	mm	ø D1 mm	ø D2 mm	L mm	L1 mm	g	TL/Ad.
14000 005001	E4	6	16.8	28	3.6	20	160,25
14000 005002	E5	7	16.8	28	4	20	160,25
14000 005003	E6	8	16.8	28	5	20	160,25
14000 005004	E7	9	16.8	28	6	20	160,25
14000 005005	E8	10	16.8	28	6.5	20	160,25
14000 005006	E10	12	16.8	28	7	25	160,25
14000 005007	E11	12.8	16.8	28	8	25	160,25
14000 005008	E12	14.3	16.8	28	9	25	160,25
14000 005009	E14	15.9	17.8	28	9.5	30	160,25
14000 005010	E16	18	19.8	28	10.5	40	165,75
14000 005011	E18	20	21.8	28	11	50	171,00

### 3/8" Lokmalı Allen Uç (mm) Hexagonal Bits Socket Wrench



3/8"

Krom vanadyum, Krom kaplı  
Chrom vanadium, Chrom plated

KOD CODE	mm	L mm	g		TL/ Ad.
14000 004993	3	50	35	10	201,25
14000 004994	4	50	35	10	201,25
14000 004995	5	50	35	10	201,25
14000 004996	6	50	35	10	201,25
14000 004997	7	50	40	10	217,75
14000 004998	8	50	40	10	217,75
14000 004999	9	50	50	10	254,75
14000 005000	10	50	50	10	254,75

### 3/8" Lokmalı Star (Torx®) Uç Star Torx® Bits Socket Wrench



3/8"

Krom vanadyum, Krom kaplı  
Chrom vanadium, Chrom plated

KOD CODE		L mm	g		TL/ Ad.
14000 004983	T8	50	35	10	178,00
14000 004984	T9	50	35	10	178,00
14000 004985	T10	50	35	10	201,25
14000 004986	T15	50	35	10	201,25
14000 004987	T20	50	35	10	201,25
14000 004988	T25	50	35	10	201,25
14000 004989	T27	50	35	10	201,25
14000 004990	T30	50	35	10	201,25
14000 004991	T40	50	35	10	201,25
14000 004992	T45	50	40	10	230,00

Havali aletler ile kullanmayınız / Do not use with power-tools

### 1510 06 0200

### 3/8" Cırcır Kolu (32 Diş) Ratchet Handle (32 Teeth)

TS ISO 3315  
DIN 3122



3/8"

Krom vanadyum, Krom kaplı  
Chrom vanadium, Chrom plated

KOD CODE	L mm	g		TL/ Ad.
1510 06 0200	200	290	5	1.336,75

### 1510

### 3/8" Ara Kol Extension Bar

TS ISO 1174-1  
TS ISO 3316  
DIN 3123



3/8"

Krom vanadyum, Krom kaplı  
Chrom vanadium, Chrom plated

KOD CODE	L mm	g		TL/ Ad.
1510 06 0075	75	75	5	204,25
1510 06 0150	150	145	5	308,00

### 1510 06 0056

### 3/8" Mafsal Universal Joint

TS ISO 3316  
DIN 3123



3/8"

Krom vanadyum, Krom kaplı  
Chrom vanadium, Chrom plated

KOD CODE	L mm	g		TL/ Ad.
1510 06 0056	56.5	65	5	329,75

**1510 06 1200**
**3/8" T Kol**  
Sliding T - Handle

 TS ISO 3315  
DIN 3122

**3/8"**

 Krom vanadyum, Krom kaplı  
Chrom vanadium, Chrom plated

KOD CODE	L mm	g		TL/Ad.
1510 06 1200	200	170	5	475,00

**1510 06 0007**
**3/8" Lokma Adaptörü**  
Adapter

 TS ISO 3316  
DIN 3123

**3/8"**

 Krom vanadyum, Krom kaplı  
Chrom vanadium, Chrom plated

KOD CODE	inch	g		TL/Ad.
1510 06 0007	3/8"Fx1/2"M	50	5	227,25

**1110 00 6019**
**3/8" Altı Köşe Lokma Anahtar Takımı** (19 parça, mm)  
6 Points Socket Wrench Set (19 Pcs, mm)

**3/8"**

KOD CODE	LOKMA LAR Sockets	AVADANLIKLAR Accessories	g		TL/Ad.
1110 00 6019	6 - 7 - 8 - 9 10 - 11 - 12 13 - 14 - 17 19 - 21 - 23 Altı Köşe Six Points 20.8 Buji Lokma Lastikli Altı Köşe Spark Plug Socket With Rubber	3/8" Cırcır Kolu Ratchet Handle 3/8" Mafsal Universal Joint 3/8" T Kol Sliding T Handle 3/8" Ara Kol Extension Bar 75 mm 3/8" Ara Kol Extension Bar 150 mm	1425	19	4.561,25

**14000 005134**
**3/8" Altı Köşe Lokma Anahtar Set** (24 parça, mm)  
Socket Wrench Set 6 Points (24 Pcs, mm)

**3/8"**

KOD CODE	LOKMA LAR Sockets	AVADANLIKLAR Accessories	g		TL/Ad.
14000 005134	7 - 8 - 9 10 - 11 - 12 13 - 14 - 15 16 - 17 - 19 Altı Köşe Six Points 8 - 10 - 11 12 - 13 - 14 16 - 17 - 19 Altı Köşe Derin Six Points Deep	3/8" Cırcır Kolu Ratchet Handle 3/8" Mafsal Universal Joint 3/8" Ara Kol Extension Bar 75 mm	2005	24	5.922,50

**14000 005135**
**3/8" Altı Köşe Lokma Anahtar & Lokmalı Allen Set** (35 parça, mm)  
Socket Wrench Set 6 Points and Hexagonal Bit Socket Wrench Set (35 Pcs, mm)

**3/8"**

KOD CODE	LOKMA LAR Sockets	AVADANLIKLAR Accessories	g		TL/Ad.
14000 005135	6 - 7 - 8 - 9 10 - 11 - 13 14 - 17 - 19 Altı Köşe Six Points E4 - E5 - E6 E7 - E8 - E10 E12 - E14 - E16 E18 Star (Torx®) Lokma Anahtar Torx Socket Wrench	3/8" Cırcır Kolu Ratchet Handle 3/8" Mafsal Universal Joint 3/8" Ara Kol Extension Bar 75 mm - 150 mm 3/8" T Kol Sliding T Handle H3 - H4 - H5 - H6 - H8 Lokma Allen Uç Hexagonal Bit Socket T20 - T25 - T27 T30 - T40 Lokmalı Star (Torx®) Uç	2230	35	5.345,00

Havalı aletler ile kullanmayınız / Do not use with power-tools

1113 00 6145

### 1/2" Lokma Anahtar Sehpası (145 Parça)

Display Frame for Sockets (145 Pcs)



1/2"

KOD CODE	İÇERİK CONTENTS	g	□	TL/Ad.
1113 00 6145	Dolu/Full 10-11-12-13-14-15-16-17-18-19 10 adet / 10 Pcs 21-22-23-24-26-27-28-30-32 5 Adet / 5 Pcs	18235	1	33.731,00

1113

### 1/2" Altı Köşe Lokma Anahtar (mm)

Socket Wrench 6 Points (mm)



TS ISO 2725 -1  
DIN 3124

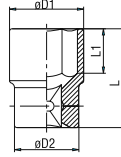

1/2"

Krom vanadyum, Krom kaplı  
Chrom vanadium, Chrom plated

KOD CODE	mm	σ D1 mm	σ D2 mm	L mm	L1 mm	g	□	TL/ Ad.
1113 06 1008	8	14	22	38	7	50	10	145,25
1113 06 1009	9	14.1	22	38	7	50	10	145,25
1113 06 1010	10	15.4	22	38	8	50	10	179,50
1113 06 1011	11	16.6	22	38	8	50	10	179,50
1113 06 1012	12	17.8	22	38	9	50	10	179,50
1113 06 1013	13	19	22	38	10	55	10	193,00
1113 06 1014	14	20.4	22	38	11	55	10	193,00
1113 06 1015	15	21.6	22	38	11	55	10	193,00
1113 06 1016	16	22.9	22	38	11	60	10	202,75
1113 06 1017	17	24	22	38	12	65	10	202,75
1113 06 1018	18	25.4	23	38	13	70	10	202,75
1113 06 1019	19	26.6	23	38	13	70	10	211,00
1113 06 1020	20	28	24	38	13	80	10	211,00
1113 06 1021	21	29.2	24	38	13	80	5	211,00
1113 06 1022	22	30.4	26	38	15	95	5	211,00
1113 06 1023	23	31.2	28	38	15	105	5	220,50
1113 06 1024	24	32.9	28	38	17	115	5	220,50
1113 06 1025	25	33.2	29	42	17	130	5	220,50
1113 06 1026	26	34	30	42	17	135	5	220,50
1113 06 1027	27	36.6	30	42	19	155	5	252,00
1113 06 1028	28	37.5	30	42	20	155	5	252,00
1113 06 1029	29	39.5	32	42	21	185	5	265,75
1113 06 1030	30	40	32	44	21	190	5	265,75
1113 06 1032	32	43	34	44	23	225	5	275,25

Havali aletler ile kullanmayınız / Do not use with power-tools

### 1000V 1/2" Altı Köşe Lokma Anahtar (mm)

Socket Wrench 6 Points 1000V (mm)

TS ISO 2725 -1  
DIN 3124  
△ 1000 V  
IEC 60900

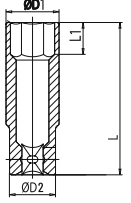

1/2"

Krom vanadyum, Krom kaplı  
Chrom vanadium, Chrom plated

KOD CODE	mm	σ D1 mm	σ D2 mm	L mm	L1 mm	g	□	TL/ Ad.
13000 005148	10	19,5	27	40	7	55	1	751,50
13000 005149	11	20,7	27	40	7	60	1	747,00
13000 005150	12	22	27	40	8	60	1	760,75
13000 005151	13	23,2	27	40	8	60	1	763,75
13000 005152	14	24,5	27	40	9	60	1	769,00
13000 005153	15	25,7	27	40	10	65	1	773,00
13000 005154	16	27	27	40	11	70	1	788,25
13000 005155	17	28,2	27	40	11	70	1	799,25
13000 005156	19	30,7	27	42	11	80	1	815,50
13000 005157	22	34,5	27	44	12	105	1	836,00
13000 005158	24	37	27	46	13	125	1	852,50
13000 005159	27	40,7	27	48	13	170	1	1.005,50

1113

### 1/2" Buji Lokma Anahtar (Lastikli)

Spark Plug Socket with Rubber



1/2"

Krom vanadyum, Krom kaplı  
Chrom vanadium, Chrom plated

KOD CODE	mm	L mm	g	□	TL/ Ad.
1113 06 9160	16	75	125	10	259,00
1113 06 9208	21	85	205	10	334,25

1114

**1/2" Oniki Köşe Lokma Anahtar (mm)**  
 Socket Wrench 12 Points (mm)

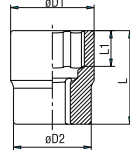
 TS ISO 2725 - 1  
 DIN 3124

1/2"

 Krom vanadyum, Krom kaplı  
 Chrom vanadium, Chrom plated

KOD CODE	Ø mm	σ D1 mm	σ D2 mm	L mm	L1 mm	g	TL/Ad.
1114 06 1010	10	15	23.3	38	8	45	10 180,75
1114 06 1011	11	16.4	23.3	38	8	45	10 180,75
1114 06 1012	12	17.8	23.3	38	9	50	10 180,75
1114 06 1013	13	19	23.3	38	10	50	10 194,50
1114 06 1014	14	20.4	23.3	38	11	50	10 194,50
1114 06 1015	15	21.6	23.3	38	11	50	10 194,50
1114 06 1016	16	22.9	24	38	11	50	10 202,75
1114 06 1017	17	24	22.5	38	12	60	10 202,75
1114 06 1018	18	25.2	23	38	13	65	10 202,75
1114 06 1019	19	26.8	23	38	13	60	10 212,25
1114 06 1020	20	28	23	38	13	65	10 212,25
1114 06 1021	21	29.2	23	38	13	70	5 212,25
1114 06 1022	22	30.2	24	40	15	85	5 212,25
1114 06 1023	23	31.4	25	40	15	105	5 220,50
1114 06 1024	24	32.6	26	42	17	100	5 220,50
1114 06 1026	26	35.3	28	42	17	125	5 249,25
1114 06 1027	27	36.6	28	42	19	140	5 284,75
1114 06 1028	28	37.8	30	42	20	170	5 284,75
1114 06 1030	30	40	30	44	21	190	5 298,50
1114 06 1032	32	42.5	30	44	23	205	5 312,25

1413

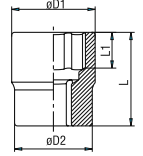
**1/2" Oniki Köşe Lokma Anahtar (SAE)**  
 Socket Wrench 12 Points (SAE)

1/2"

 Krom vanadyum, Krom kaplı  
 Chrom vanadium, Chrom plated

KOD CODE	Ø inch	σ D1 mm	σ D2 mm	L mm	L1 mm	g	TL/Ad.
1413 06 1008	5/16"	13.2	21.8	37	6	50	10 211,00
1413 06 1095	3/8"	15	21.8	37	8	50	10 211,00
1413 06 1010	7/16"	16.4	23.3	37	9	50	10 217,75
1413 06 1011	15/32"	18	23.3	37	9	50	10 217,75
1413 06 1012	1/2"	19	23.3	37	9	55	10 227,25
1413 06 1013	9/16"	20.4	23.3	37	11	55	10 234,00
1413 06 1014	19/32"	21.6	23.3	37	11	50	10 234,00
1413 06 1015	5/8"	23.1	22	38	11	50	10 237,00
1413 06 1016	11/16"	24.5	22.5	38	11	60	10 245,25
1413 06 1017	3/4"	26.8	23	38	13	60	10 247,75
1413 06 1020	25/32"	28	23	38	13	80	10 256,00
1413 06 1021	13/16"	28.6	23	38	13	75	10 256,00
1413 06 1022	7/8"	30.2	24	40	15	85	5 256,00
1413 06 1024	15/16"	32.6	26	42	17	100	5 267,00
1413 06 1025	1"	35	28	42	17	125	5 267,00
1413 06 1027	1 1/16"	36.6	28	42	19	140	5 349,00
1413 06 1029	1 1/8"	38.8	30	42	19	160	5 349,00
1413 06 1030	1 3/16"	40	29.5	44	20	185	5 349,00
1413 06 1032	1 1/4"	42.5	30	44	22	210	5 349,00

14000 005130

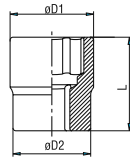
**1/2" Twist Lokma Anahtar Set (10 parça, mm)**  
 Twist Socket Wrench Set (10 Pcs, mm)

1/2"

 Krom molibden, Fosfat kaplamalı  
 Chrom molybdenum, Phosphate finish

KOD CODE	mm	σ D1 mm	σ D2 mm	L mm	Ad. Boy	g	TL/Ad.
	10	16	22	34	-		1
	11	17.5	22	34	-		1
	12	18.5	22	34	-		1
	13	20.4	22	34	-		1
	14	21.5	25	34	-		1
14000 005130	15	22.5	25	34	-	795	1 6.436,50
	16	23.5	25	34	-		1
	17	25.8	25	34	-		1
	19	28.7	27	34	-		1
	Adaptör / Adapter				80		1



Havalet aletler ile kullanmayınız / Do not use with power-tools

1108

### 1/2" Altı Köşe Derin Lokma Anahtar (mm) Deep Socket Wrench 6 Points (mm)

TS ISO 2725 - 1  
DIN 3124

1/2"

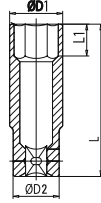
Krom vanadyum, Krom kaplı  
Chrom vanadium, Chrom plated

KOD CODE	Ø mm	ØD1 mm	ØD2 mm	L mm	L1 mm	g	TL/ Ad.
1108 06 0010	10	15,2	22	75	6	80	10 335,25
1108 06 0011	11	16,7	24	75	7	90	10 335,25
1108 06 0012	12	18	24	75	8	95	10 335,25
1108 06 0013	13	19	24	75	8	110	10 360,00
1108 06 0014	14	20,5	24	75	10	110	10 360,00
1108 06 0015	15	21,7	24	75	10	110	10 360,00
1108 06 0016	16	22	25,5	75	10	110	10 376,25
1108 06 0017	17	24	25,5	75	10	130	10 376,25
1108 06 0018	18	25,5	25,5	75	12	140	10 376,25
1108 06 0019	19	26	26,7	75	12	140	10 394,25
1108 06 0020	20	28	28	75	12,4	195	10 414,00
1108 06 0021	21	29,2	29,2	75	12,9	165	10 434,75
1108 06 0022	22	30,5	30,5	75	13,9	165	10 456,50
1108 06 0024	24	33	33	75	14,9	210	10 492,50
1108 06 0027	27	36,7	36,7	75	15,9	270	10 654,50
1108 06 0030	30	40,5	40,5	75	18,1	305	10 729,75
1108 06 0032	32	43	43	75	18,8	335	10 792,50

1108 00 6010

### 1/2" Altı Köşe Derin Lokma Anahtar Takımı (10 parça mm) Deep Socket Wrench 6 Points (10 Pcs, mm)



1/2"



KOD CODE	İÇERİK CONTENTS	g	TL/ Ad.
1108 00 6010	10-11-12-13-14-15 16-17-18-19	1290	10 3.608,75

1113

### 1/2" Star (Torx®) Lokma Anahtar Star Torx® Socket Wrench

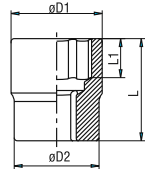

1/2"

Krom vanadyum, Krom kaplı  
Chrom vanadium, Chrom plated

KOD CODE	Ø mm	ØD1 mm	ØD2 mm	L mm	L1 mm	g	TL/ Ad.
1113 06 0210	E10	13.2	23.8	37	7.5	25	10 172,50
1113 06 0212	E12	15	23.8	37	9	25	10 172,50
1113 06 0214	E14	16.4	23.8	37	10	30	10 172,50
1113 06 0216	E16	18.8	23.8	37	11	40	10 172,50
1113 06 0218	E18	20.5	23.8	39	12.5	75	10 172,50
1113 06 0220	E20	23	23.8	39	14	80	10 194,50

1113 00 6007

### 1/2" Star (Torx®) Lokma Anahtar Takımı (7 Parça) Star Torx® Socket Wrench Set (7 Pcs)



1/2"



KOD CODE	İÇERİK CONTENTS	g	TL/ Ad.
1113 00 6007	Star Lokma / Star Socket E10 - E12 - E14 - E16 - E18 - E20 125 mm Ara Kol / Extension Bar	905	7 1.434,75

Havali aletler ile kullanmayınız / Do not use with power-tools

**1113**
**1/2" Lokmalı Allen Uç (mm)**  
 Hexagonal Bit Socket Wrench

**1/2"**

 Krom vanadyum, Krom kaplı  
 Chrom vanadium, Chrom plated

KOD CODE	mm	L mm	g		TL/Ad.
1113 06 1105	5	60	60	10	230,00
1113 06 1106	6	60	60	10	230,00
1113 06 1107	7	60	65	10	230,00
1113 06 1108	8	60	65	10	230,00
1113 06 1110	10	60	75	10	263,00
1113 06 1112	12	60	90	10	263,00
1113 06 1114	14	60	105	10	263,00
1113 06 4105	5	100	75	10	272,50
1113 06 4106	6	100	80	10	272,50
1113 06 4107	7	100	80	10	272,50
1113 06 4108	8	100	80	10	272,50
1113 06 4110	10	100	125	10	314,75
1113 06 4112	12	100	125	10	314,75
1113 06 4114	14	100	160	10	377,75
1113 06 4117	17	100	240	10	505,25

**1113**
**1/2" Lokmalı Star (Torx®) Uç**  
 Star (Torx®) Bit Socket Wrench

**1/2"**

 Krom vanadyum, Krom kaplı  
 Chrom vanadium, Chrom plated

KOD CODE	★	L mm	g		TL/Ad.
1113 06 1220	T20	55	60	10	283,50
1113 06 1225	T25	55	60	10	283,50
1113 06 1227	T27	55	60	10	283,50
1113 06 1230	T30	55	60	10	283,50
1113 06 1240	T40	55	60	10	283,50
1113 06 1245	T45	55	60	10	283,50
1113 06 1250	T50	55	60	10	283,50
1113 06 1255	T55	55	70	10	283,50
1113 06 1260	T60	55	95	10	301,00
1113 06 4220	T20	100	75	10	320,50
1113 06 4225	T25	100	80	10	320,50
1113 06 4227	T27	100	80	10	320,50
1113 06 4230	T30	100	80	10	320,50
1113 06 4240	T40	100	60	10	320,50
1113 06 4245	T45	100	60	10	320,50
1113 06 4250	T50	100	80	10	320,50
1113 06 4255	T55	100	100	10	320,50
1113 06 4260	T60	100	150	10	332,75

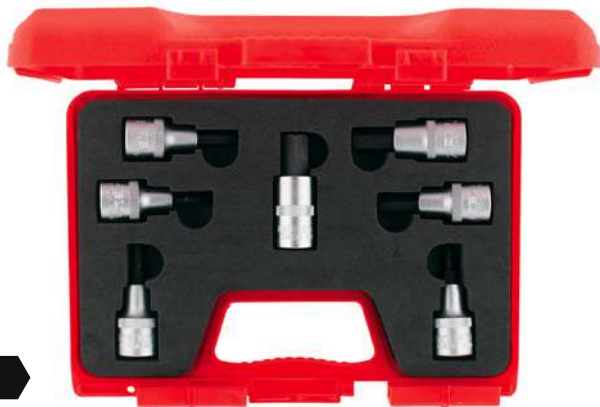
**1113 00 1107**
**1/2" Lokmalı Allen Uç Takımı (60 mm, 7 Parça)**  
 Hexagonal Bits Socket Wrench Set (60 mm, 7 Pcs)

**1/2"**

KOD CODE	İÇERİK CONTENTS	g		TL/Ad.
1113 00 1107	Allen Uçlar 60mm Hex Bit Socket 5-6-7-8-10-12-14	800	7	1.709,00

**1113 00 6009**
**1/2" Lokmalı Star (Torx®) Uç Takımı (55 mm, 9 parça)**  
 Torx® Bits Socket Wrench Set (55 mm, 9 Pcs)

**1/2"**

KOD CODE	İÇERİK CONTENTS	g		TL/Ad.
1113 00 6009	Torx® Uçlar 55mm Star Socket T20 - T25 - T27 - T30 - T40 - T45 T50 - T55 - T60	850	9	2.569,00

1113 00 6017

### 1/2" Lokmalı Allen Uç ve Star (Torx®) Uç Takımı (17 Parça)

Hex Bit Sockets - Torx® Bit Sockets Set (17 Pcs)



1/2"

KOD CODE	İÇERİK CONTENTS	g	TL/Ad.
1113	T Kol (1/2") Sliding T Handle		
1113	5 - 6 - 7 - 8 - 10 - 12 - 14 Lokmalı Allen Uç 60mm Hex Bit Socket	2955	17 5.101,75
1113	T20 - T25 - T27 T30 - T40 T45 - T50 - T55 - T60 Lokmalı Star (Torx®) Uç 55mm Torx® Bit Socket		

1114

### 1/2" Oniki Köşe Lokmalı Bits Uç Yivli (XZN)

Hex Bit Socket 12 Points (XZN)



1/2"

Krom vanadyum, Krom kaplı  
Chrom vanadium, Chrom plated

KOD CODE		L mm	g	TL/Ad.
1114 06 4005	M5	60	60	10 208,25
1114 06 4006	M6	60	60	10 208,25
1114 06 4008	M8	60	60	10 208,25
1114 06 4010	M10	60	75	10 208,25
1114 06 4012	M12	60	85	10 247,75
1114 06 4106	M6	80	70	10 263,00
1114 06 4108	M8	80	70	10 263,00
1114 06 4110	M10	80	85	10 290,25
1114 06 4112	M12	80	105	10 300,00
1114 06 4114	M14	80	130	10 320,50
1114 06 4208	M8	140	95	10 295,75
1114 06 4210	M10	140	125	10 361,50
1114 06 4212	M12	140	165	10 406,50
1114 06 4214	M14	140	210	10 457,25
1114 06 4216	M16	140	310	10 662,50

Havali aletler ile kullanmayınız / Do not use with power-tools

1114

### 1/2" Lokmalı Ribe Bits Uç

Ribe Bit Socket Wrench



1/2"

Krom vanadyum, Krom kaplı  
Chrom vanadium, Chrom plated

KOD CODE		L mm	g	TL/Ad.
1114 06 5004	4	100	75	10 286,25
1114 06 5005	5	100	75	10 286,25
1114 06 5006	6	100	80	10 286,25
1114 06 5007	7	100	75	10 286,25
1114 06 5008	8	100	80	10 286,25
1114 06 5009	9	100	95	10 288,75
1114 06 5010	10	100	100	10 288,75
1114 06 5011	10.5	100	125	10 295,75
1114 06 5012	12	100	150	10 368,25
1114 06 5013	13	100	155	10 403,75
1114 06 5014	14	100	215	10 403,75
1114 06 5016	16	100	515	10 546,25

1513 06 0032

### 1/2" Cırcır Kolu (32 Diş)

Ratchet Handle (32 Teeth)



TS ISO 3315  
DIN3122



1/2"

Krom vanadyum, Krom kaplı  
Chrom vanadium, Chrom plated

KOD CODE	L mm	g	TL/Ad.
1513 06 0032	250	540	5 1.488,75

13000 005277

### 1000V 1/2" Cırcır Kolu (36 Diş)

Ratchet Handle 1000V (36 Teeth)

1000 V  
IEC 60900



1/2"

KOD CODE	L mm	g	TL/Ad.
13000 005277	275	625	1 7.246,50

**1513**
**1/2" Ara Kol**  
 Extension Bar

 TS ISO 1174-1  
 TS ISO 3316  
 DIN 3123

**1/2"**

 Krom vanadyum, Krom kaplı  
 Chrom vanadium, Chrom plated

KOD CODE	L mm	g	□	TL/Ad.
1513 06 4075	75	140	5	338,25
1513 06 4125	125	220	5	377,75
1513 06 4250	250	425	5	573,50

**1000V 1/2" Ara Kol**  
 Extension Bar 1000V

 1000 V  
 IEC 60900

**1/2"**

 Krom vanadyum, Krom kaplı  
 Chrom vanadium, Chrom plated

KOD CODE	L mm	g	□	TL/Ad.
13000 005262	75	235	1	1.921,00
13000 005263	125	470	1	2.130,25
13000 005264	250	465	1	2.892,25

**1513 06 5250**
**1/2" T Kol Adaptörü**  
 Adapter

**1/2"**

 Krom vanadyum, Krom kaplı  
 Chrom vanadium, Chrom plated

KOD CODE	inch	g	□	TL/Ad.
1513 06 5250	3/8"Fx1/2"M	75	5	351,75

**1513 06 2250**
**1/2" T Kol**  
 Sliding T Handle

 TS ISO 3315  
 DIN 3122

**1/2"**

 Krom vanadyum, Krom kaplı  
 Chrom vanadium, Chrom plated

KOD CODE	L mm	g	□	TL/Ad.
1513 06 2250	250	370	5	823,75

**13000 005541**
**1000V 1/2" T Kol**  
 1000V Sliding T - Handle

 1000 V  
 IEC 60900

**1/2"**

 Krom vanadyum, Krom kaplı  
 Chrom vanadium, Chrom plated

KOD CODE	L mm	g	□	TL/Ad.
13000 005541	200	695	5	1.766,25

**1513 06 4070**
**1/2" Mafsal**  
 Universal Joint

 TS ISO 3316  
 DIN 3123

**1/2"**

 Krom vanadyum, Krom kaplı  
 Chrom vanadium, Chrom plated

KOD CODE	L mm	g	□	TL/Ad.
1513 06 4070	70	150	5	479,00

**1513**
**1/2" Lokma Adaptörü**  
 Adapter

 TS ISO 3316  
 DIN 3123

**1/2"**

 Krom vanadyum, Krom kaplı  
 Chrom vanadium, Chrom plated

KOD CODE	inch	g	□	TL/Ad.
1513 06 0002	1/2"Fx3/8"M	45	5	178,00
1513 06 0003	1/2"Fx3/4"M	115	5	278,00

**1113 06 5010**
**1/2" Bits Tutucu Lokma**  
 Bit Holder Socket

**1/2"**

 Krom vanadyum, Krom kaplı  
 Chrom vanadium, Chrom plated

KOD CODE	inch	g	□	TL/Ad.
1113 06 5010	1/2" F x 1/4" F	55	5	202,75



1113 00 1038

1/4" - 1/2" Altı Köşe Lokma Anahtar Takımı (35 Parça)  
Socket Wrench Set 6 Point 1/4" - 1/2" (35 Pcs)



1/4"

1/2"

KOD CODE	LOKMALAR Sockets	AVADANLIKLAR Accessories	 g		TL/Ad.
1113 00 1038	4 - 5 - 6 7 - 8 - 9 - 10 11 - 12 - 13 Altı Köşe Six Points	1/4" Cırcır kolu Ratchet Handle  1/4" Mafsal Universal Joint  1/4" T Kol Sliding T Handle  1/4" Ara Kol Extension Bar 50 mm  1/4" Ara Kol Extension Bar 100 mm	4020	35	7.424,75
	10 - 11 - 12 13 - 14 - 15 16 - 17 - 18 19 - 21 - 22 24 - 27 - 30 32 Altı Köşe Six Points	1/2" Cırcır Kolu Ratchet Handle  1/2" T Kol Adaptör Sliding T Handle Adapter  1/2" Ara Kol Extension Bar 75 mm  1/2" Ara Kol Extension Bar 250 mm			

Havali aletler ile kullanmayınız / Do not use with power-tools

**1113 00 2017**

1/2" Altı Köşe Lokma Anahtar Takımı (17 Parça, mm)  
Socket Wrench Set 6 Points (17 pcs, mm)

**1113 00 2024**

1/2" Altı Köşe Lokma Anahtar Takımı (24 Parça, mm)  
Socket Wrench Set 6 Points (24 pcs, mm)



KOD CODE	LOKMALAR Sockets	AVADANLIKLAR Accessories	g	TL/Ad.
1113 00 2017		1/2" Cırcır Kolu Ratchet Handle	3305	17
		1/2" T Kol Adaptör Sliding T Handle Adapter		
	10 - 11 - 12 13 - 14 - 15 17 - 19 - 22 24 - 27 - 30 32	1/2" Mafsal Universal Joint		
		1/2" Ara Kol Extension Bar 250 mm		

KOD CODE	LOKMALAR Sockets	AVADANLIKLAR Accessories	g	TL/Ad.
1113 00 2024		1/2" Cırcır Kolu Ratchet Handle	4145	24
		1/2" Mafsal Universal Joint		
	10 - 11 - 12 13 - 14 - 15 16 - 17 - 18 19 - 21 - 22 23 - 24 - 26 27 - 28 - 30 32	1/2" T Kol Adaptör Sliding T Handle Adapter		
		1/2" Ara Kol Extension Bar 125 mm		
		1/2" Ara Kol Extension Bar 250 mm		

**1114 00 6024**

1/2" Oniki Köşe Lokma Anahtar Takımı (24 Parça, mm)  
Socket Wrench Set 12 Points (24 pcs, mm)

**1413 00 6024**

1/2" Oniki Köşe Lokma Anahtar Takımı (24 parça, SAE)  
Socket Wrench Set 12 Points (24 pcs, SAE)



KOD CODE	LOKMALAR Sockets	AVADANLIKLAR Accessories	g	TL/Ad.
1114 00 6024		1/2" Cırcır Kolu Ratchet Handle	4150	24
		1/2" Mafsal Universal Joint		
	10 - 11 - 12 13 - 14 - 15 16 - 17 - 18 19 - 21 - 22 23 - 24 - 26 27 - 28 - 30 32	1/2" T Kol Adaptör Sliding T Handle Adapter		
		1/2" Ara Kol Extension Bar 125 mm		
		1/2" Ara Kol Extension Bar 250 mm		

KOD CODE	LOKMALAR Sockets	AVADANLIKLAR Accessories	g	TL/Ad.
1413 00 6024		1/2" Cırcır Kolu Ratchet Handle	4150	24
		1/2" Mafsal Universal Joint		
	5/16" - 3/8" 7/16" - 15/32" 1/2" - 9/16" 19/32" - 5/8" 11/16" - 3/4" 25/32" - 13/16" 7/8" - 15/16" 1" - 1 1/16" 1 1/8" - 1 3/16" 1 1/4"	1/2" T Kol Adaptör Sliding T Handle Adapter		
		1/2" Ara Kol Extension Bar 125 mm		
		1/2" Ara Kol Extension Bar 250 mm		



**1113 00 1038**

1/4" - 1/2" Altı Köşe Lokma Anahtar  
Takımı (35 parça, mm)  
Socket Wrench Set 6 Points 1/4" (35 pcs, mm)



**1114 00 6024**

1/2" Oniki Köşe Lokma Anahtar  
Takımı (24 parça, mm)  
Socket Wrench Set 12 Points  
(24 pcs, mm)



**1107 00 6014**

1/4" Altı Köşe Derin Lokma  
Anahtar Set (14 parça, mm)  
Deep Socket Wrench Set  
Type 6 Points (14 pcs, mm)

**1119**
**3/4" Altı Köşe Lokma Anahtar (mm)**  
 Socket Wrench 6 Points (mm)

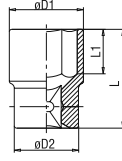
 TS ISO 2725 -1  
 DIN 3124

**3/4"**

 Krom vanadyum, Krom kaplı  
 Chrom vanadium, Chrom plated

KOD CODE	Ø mm	Ø D1 mm	Ø D2 mm	L mm	L1 mm	g	TL/ Ad.
1119 06 1022	22	33	36	52	16	215	5 446,25
1119 06 1024	24	35	36	52	16	225	5 446,25
1119 06 1027	27	38	36	52	19	235	5 459,75
1119 06 1030	30	42	38	54	21	290	5 495,50
1119 06 1032	32	44	38	56	23	315	5 516,00
1119 06 1034	34	47	42	58	24	390	5 680,25
1119 06 1036	36	50	42	58	25	445	5 680,25
1119 06 1038	38	52	45	60	27	495	5 680,25
1119 06 1041	41	56	45	64	29	585	1 997,50
1119 06 1046	46	62	48	68	33	740	1 1.063,25
1119 06 1050	50	68	48	72	34	895	1 1.276,75
1119 06 1055	55	74	48	76	37	985	1 1.624,00
1119 06 1060	60	80	48	78	38	1140	1 1.940,00

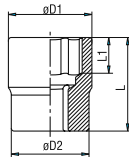
**1120**
**3/4" Oniki Köşe Lokma Anahtar (mm)**  
 Socket Wrench 12 Points (mm)

 TS ISO 2725 - 1  
 DIN 3124

**3/4"**

 Krom vanadyum, Krom kaplı  
 Chrom vanadium, Chrom plated

KOD CODE	Ø mm	Ø D1 mm	Ø D2 mm	L mm	L1 mm	g	TL/ Ad.
1120 06 1022	22	33	36	52	16	215	5 471,00
1120 06 1024	24	35	36	52	17	220	5 471,00
1120 06 1027	27	38	36	52	19	235	5 485,75
1120 06 1030	30	42	38	54	21	285	5 522,75
1120 06 1032	32	44	38	56	23	315	5 546,25
1120 06 1034	34	47	42	57	24	390	5 718,25
1120 06 1036	36	50	42	58	25	435	5 718,25
1120 06 1041	41	56	45	64	29	575	1 1.060,25
1120 06 1046	46	62	47	68	34	695	1 1.127,50
1120 06 1050	50	68	48	72	34	875	1 1.349,00

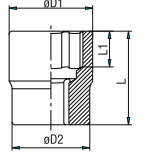
Havali aletler ile kullanmayınız / Do not use with power-tools

**1419**
**3/4" Oniki Köşe Lokma Anahtar (SAE)**  
 Socket Wrench 12 Points (SAE)

**3/4"**

 Krom vanadyum, Krom kaplı  
 Chrom vanadium, Chrom plated

KOD CODE	Ø inch	Ø D1 mm	Ø D2 mm	L mm	L1 mm	g	TL/ Ad.
1419 06 1022	7/8"	33	36	52	16	220	5 494,00
1419 06 1024	15/16"	35	36	52	16	220	5 494,00
1419 06 1025	1"	35	36	52	17	220	5 495,50
1419 06 1027	1 1/16"	38	36	52	19	230	5 509,25
1419 06 1028	1 1/8"	40	38	52	19	255	5 509,25
1419 06 1032	1 1/4"	44	38	56	23	315	5 570,75
1419 06 1033	1 5/16"	46	38	56	23	350	5 710,25
1419 06 1035	1 3/8"	48	42	58	25	400	5 710,25
1419 06 1036	1 7/16"	50	42	58	25	425	5 743,00
1419 06 1038	1 1/2"	52	45	60	27	480	5 743,00
1419 06 1041	1 5/8"	56	45	64	29	565	1 1.101,25
1419 06 1044	1 3/4"	60	47	66	31	655	1 1.161,75
1419 06 1046	1 13/16"	62	47	68	34	685	1 1.168,50
1419 06 1047	1 7/8"	64	48	70	34	735	1 1.402,25
1419 06 1050	2"	68	48	72	34	795	1 1.412,00

**1519 06 4510**
**3/4" Cırcır Kolu (45 Diş)**  
 Ratchet Handle (45 Teeth)

 TS ISO 3315  
 DIN 3122

**3/4"**

 Krom vanadyum, Krom kaplı  
 Chrom vanadium, Chrom plated

KOD CODE	L mm	g	TL/ Ad.
1519 06 4510	510	2240	5 4.409,25

**1519**
**3/4" Ara Kol**  
 Extension Bar

 TS ISO 1174-1  
 TS ISO 3316  
 DIN 3123

**3/4"**

 Krom vanadyum, Krom kaplı  
 Chrom vanadium, Chrom plated

KOD CODE	L mm	g	TL/ Ad.
1519 06 4200	200	705	5 1.164,25
1519 06 4400	400	1265	5 2.106,75

1519 06 4500

3/4" T Kol  
Sliding T - Handle

TS ISO 3315  
DIN 3122



3/4"

Krom vanadyum, Krom kaplı  
Chrom vanadium, Chrom plated

KOD CODE	L mm	g		TL/Ad.
1519 06 4500	500	4530	5	2.343,75

1519

3/4" Lokma Adaptörü  
Adapter

TS ISO 3316  
DIN 3123



3/4"

Krom vanadyum, Krom kaplı  
Chrom vanadium, Chrom plated

KOD CODE	inch	g		TL/Ad.
1519 06 0008	3/4"Fx1/2"M	125	5	465,25
1519 06 0001	3/4"Fx1"M	300	5	628,25

1119 00 6114

3/4" Altı Köşe Lokma Anahtar Takımı (14 parça, mm)  
Socket Wrench Set 6 Points (14 pcs, mm)



3/4"

KOD CODE	LOKMALAR Sockets	AVADANLIKLAR Accessories	g		TL/Ad.
1119 00 6114	22 - 24 - 27 30 - 32 - 34 36 - 41 - 46 - 50	3/4" Cırcır Kolu Ratchet Handle	10180	14	17.085,75
		3/4" T Kol Sliding T Handle			
		3/4" Ara Kol Extension Bar 200 mm			
		3/4" Ara Kol Extension Bar 400 mm			

1120 00 6014

3/4" Oniki Köşe Lokma Anahtar Takımı (14 parça, mm)  
Socket Wrench Set 12 Points (14 pcs, mm)



3/4"

KOD CODE	LOKMALAR Sockets	AVADANLIKLAR Accessories	g		TL/Ad.
1120 00 6014	22 - 24 - 27 30 - 32 - 34 36 - 41 - 46 50	3/4" Cırcır Kolu Ratchet Handle	12810	14	17.494,00
		3/4" T Kol Sliding T Handle			
		3/4" Ara Kol Extension Bar 200 mm			
		3/4" Ara Kol Extension Bar 400 mm			

1419 00 6114

3/4" Oniki Köşe Lokma Anahtar Takımı (14 parça, SAE)  
Socket Wrench Set 12 Points (14 pcs, SAE)



3/4"

KOD CODE	LOKMALAR Sockets	AVADANLIKLAR Accessories	g		TL/Ad.
1419 00 6114	15/16" - 11/16" 11/8" - 11/4" 15/16" 13/8" 11/2" - 15/8" 17/8" - 2"	3/4" Cırcır Kolu Ratchet Handle	10180	14	18.186,25
		3/4" T Kol Sliding T Handle			
		3/4" Ara Kol Extension Bar 200 mm			
		3/4" Ara Kol Extension Bar 400 mm			

**1225**
**1" Oniki Köşe Lokma Anahtar (mm)**  
 Socket Wrench 12 Points (mm)

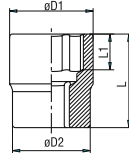
 TS ISO 2725-1  
 DIN 3124

**1"**

 Krom vanadyum, Krom kaplı  
 Chrom vanadium, Chrom plated

KOD CODE	mm	ø D1 mm	ø D2 mm	L mm	L1 mm	g	TL/Ad.
1225 06 0036	36	52	48	65	26	540	1 1.391,50
1225 06 0041	41	58	50	70	29	675	1 1.514,50
1225 06 0046	46	65	54	75	32	925	1 1.836,00
1225 06 0050	50	70	57	75	34	1025	1 2.174,00
1225 06 0055	55	76	57	83	42	1295	1 2.784,00
1225 06 0060	60	82	60	87	46	1530	1 3.618,50

**1525 06 0005**
**1" Lokma Adaptörü**  
 Adapter

 TS ISO 3316  
 DIN 3123

**1"**

 Krom vanadyum, Krom kaplı  
 Chrom vanadium, Chrom plated

KOD CODE	inch	g	TL/Ad.
1525 06 0005	1"Fx3/4" M	315	5 895,00

**1800**
**Kovan Anahtar İki Ağız (mm)**  
 Double Ended Tubular Socket Wrench (mm)

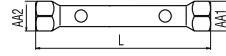
 TS ISO 3793  
 DIN 896

 Dikişsiz çelik boru, Çinko kaplı  
 Seamless steel tube, Zinc plated

KOD CODE	mm	L mm	AA1 mm	AA2 mm	Kullanılan Mil For	g	TL/Ad.
1800 07 0607	6x7	105	8.6	9.6	5x125	25	5 208,25
1800 07 0809	8x9	105	11.2	12.2	5x125	35	5 227,25
1800 07 1011	10x11	120	13.6	14.6	5x125	60	5 310,75
1800 07 1213	12x13	135	16	17	8x180	85	5 329,75
1800 07 1415	14x15	135	16.5	19.5	8x180	110	5 362,75
1800 07 1617	16x17	150	21	22	10x120-10x200	155	5 388,75
1800 07 1819	18x19	150	23	24	10x120-10x200	165	5 403,75
1800 07 2022	20x22	165	25.4	27.4	10x120-10x200	225	5 443,50
1800 07 2224	22x24	180	27.4	29.4	10x200	330	5 498,25
1800 07 2427	24x27	180	30.4	33.4	10x200	345	5 643,00

**1800 00 2108**
**Kovan Anahtar Takımı İki Ağız (mil dahil, mm)**  
 Double Ended Tubular Socket Wrench Set  
 with Tommy Bars (mm)



KOD CODE	mm	g	TL/Ad.
1800 00 2108	6x7 - 8x9 - 10x11 - 12x13 - 14x15 16x17 - 18x19 - 20x22 Mil/Handle Bars 5x125-8x180 mm	85	10 2.883,00

**1841 07 0021**
**Kovan Anahtar Bir Ağız (mil dahil)**  
 Single Ended Tubular Socket Wrench with Tommy Bar

 Dikişsiz çelik boru, Çinko kaplı  
 Seamless steel tube, Zinc plated

KOD CODE	mm		L mm	øD mm	Mil Handle bar mm	g	TL/Ad.
	mm	inch					
1841 07 0021	21	13/16"	120	20	10x120	220	5 345,00

1850

### Kovan Anahtar Mili Tommy Bar

TS ISO 3793  
DIN 900

KOD CODE	σDxL mm	g	TL/Ad.
1850 07 5125	5x125	20	10 82,25
1850 07 8180	8x180	70	10 126,00
1850 07 1120	10x120	75	10 142,50
1850 07 1200	10x200	120	10 160,25

1870

### Ağır Tip Bijon Anahtarı İki Ağız Uzun Double Ended Rim Wrench (long)

TSEK

Yüksek alaşımlı çelik, Nikel kaplı  
Special steel, Nickel plated

KOD CODE	mm	L mm	t mm	σD1 mm	σD2 mm	g	TL/Ad.
1870 09 2427	24x27	400	34.5	36	40	1100	10 878,50
1870 09 2730	27x30	400	34.5	40	44	1335	10 1.008,50
1870 09 2732	27x32	400	34.5	40	46	1355	10 1.008,50
1870 09 3032	30x32	400	34.5	44	46	1420	10 1.044,00
1870 09 3233	32x33	400	34.5	46	47	1425	10 1.159,00

1874

### Ağır Tip Bijon Anahtarı İki Ağız Kısa Double Ended Rim Wrench (short)

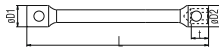
Yüksek alaşımlı çelik, Nikel kaplı  
Special steel, Nickel plated

KOD CODE	mm	L mm	t mm	σD1 mm	σD2 mm	g	TL/Ad.
1874 09 2224	22x24	170	34.5	34	36	500	10 557,00
1874 09 2427	24x27	200	34.5	36	40	605	10 711,50

1850 09 1630

### Bijon Anahtar Mili Tommy Bar

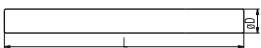
TS ISO 3793  
DIN 900

KOD CODE	σDxL mm	g	TL/Ad.
1850 09 1630	18x630	1255	1 512,00

1975 09 1719

### Bijon Anahtarı İstavroz Tipi Cross Rim Wrench

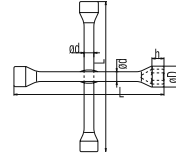
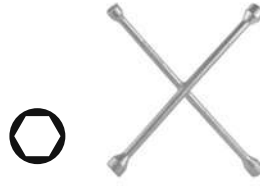

TS ISO 6788

Yüksek alaşımlı çelik, Krom kaplı  
Special steel, Chrom plated

KOD CODE	mm	inch	σD mm	h mm	L mm	σd mm	g	TL/Ad.
	17	11/16"	28	17				
1975 09 1719	19	3/4"	30	18.5	420	16	1500	10 1.086,50
	21	13/16"	32	19.5				
	22	7/8"	34	20.5				

1975 09 1322

### 1/2" Adaptörlü Bijon Anahtarı İstavroz Tipi Cross Rim Wrench (with 1/2" adapter)

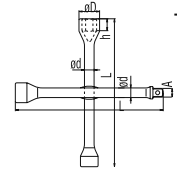
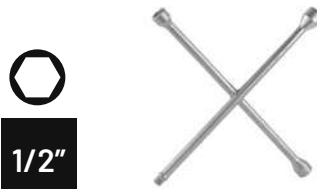

TS ISO 6788

Yüksek alaşımlı çelik, Krom kaplı  
Special steel, Chrom plated

KOD CODE	mm	inch	σD mm	h mm	L mm	A mm	σd	g	TL/Ad.
	17	11/16"	28	17					
1975 09 1322	19	3/4"	30	18.5	420	12.65	16	1500	10 1.092,00
	22	7/8"	34	20.5					
	1/2"								

1940

### Bijon Anahtarı Pipo Tipi (Tornavida Ağızlı) Offset Socket Wrench with Screwdriver

TSEK

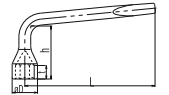
Yüksek alaşımlı çelik, Nikel kaplı  
Special steel, Nickel plated

KOD CODE	mm	inch	L mm	σD mm	h mm	g	TL/Ad.
1940 09 0017	17	11/16"	285	28	65	535	10 546,25
1940 09 0019	19	3/4"	285	30	65	540	10 577,50
1940 09 0021	21	13/16"	320	32	85	640	10 624,00

1840 08 0500

### 1/2" Mafsallı T Kol Swivel Handle With Sliding T 1/2"

1/2"

Özel alaşım çelik, Krom kaplı  
Special steel, Chrom plated

KOD CODE	mm	L mm	g	TL/Ad.
1840 08 0500	1/2"	600	830	10 2.227,50

**1610**
**3/8" Tork Anahtarı**  
Torque Wrench

 TS EN ISO 6789-1  
TS EN ISO 6789-2

**3/8"**

KOD CODE	ÖLÇÜ SIZE	L mm	g	TL/Ad.
1610 06 0100	2.5 - 11 Nm - 0.3 - 1.2 Kg	310	515	1 12.323,25
1610 06 0300	7 - 33 Nm - 0.5 - 3.4 Kg	425	1050	1 12.742,00

**1613**
**1/2" Tork Anahtarı**  
Torque Wrench

 TS EN ISO 6789-1  
TS EN ISO 6789-2

**1/2"**

KOD CODE	ÖLÇÜ SIZE	L mm	g	TL/Ad.
1613 06 1200	25 - 135 Nm - 3 - 14 Kg	550	1850	1 13.157,75
1613 06 2000	50 - 225 Nm - 5 - 23 Kg	600	1980	1 13.580,25
1613 06 3000	70 - 330 Nm - 7 - 35 Kg	830	3420	1 16.525,50

**1619 06 2080**
**3/4" Tork Anahtarı**  
Torque Wrench

 TS EN ISO 6789-1  
TS EN ISO 6789-2

**3/4"**

 İZELTAS USTA İŞİ  
SOHBETLER

KOD CODE	ÖLÇÜ SIZE	L mm	g	TL/Ad.
1619 06 2080	200 - 800 Nm - 22 - 82 kg	1030	8860	1 50.921,25

**1607 06 0420**
**1/4" Cırcırlı Tork Anahtar**  
Torque Wrench With Reversible Ratchet-Head

 TS EN ISO 6789-1  
TS EN ISO 6789-2

İZELTAS YOUTUBE

**1/4"**

KOD CODE	ÖLÇÜ SIZE	L mm	g	TL/Ad.
1607 06 0420	4 - 20 Nm	320	970	1 9.755,50

**1610 06 2010**
**3/8" Cırcırlı Tork Anahtar**  
Torque Wrench With Reversible Ratchet-Head

 TS EN ISO 6789-1  
TS EN ISO 6789-2

**3/8"**

KOD CODE	ÖLÇÜ SIZE	L mm	g	TL/Ad.
1610 06 2010	20 - 100 Nm	435	1730	1 11.014,00

**1613**
**1/2" Cırcırlı Tork Anahtar**  
Torque Wrench With Reversible Ratchet-Head

 TS EN ISO 6789-1  
TS EN ISO 6789-2

**1/2"**

KOD CODE	ÖLÇÜ SIZE	L mm	g	TL/Ad.
1613 06 4020	40 - 200 Nm	520	2010	1 12.900,25
1613 06 6034	60 - 340 Nm	610	2220	1 13.525,75

**1619 06 1060**
**3/4" Cırcırlı Tork Anahtar**  
Torque Wrench With Reversible Ratchet-Head

 TS EN ISO 6789-1  
TS EN ISO 6789-2

**3/4"**

KOD CODE	ÖLÇÜ SIZE	L mm	g	TL/Ad.
1619 06 1060	100 - 600 Nm	1050	5500	1 35.769,25



## 1/2" CIRCIR KOL / RATCHET HANDLE

**Lokmayı salmayan bilya tasarımı  
(kare adaptörlü bilyalı tasarım)**  
Square adaptor with ball design to lock  
sockets

**Değiştirilebilir iç mekanizma**  
Inter-changeable inner mechanism

**Yüksek dayanım için  
güçlü 32 diş**  
32 teeth for high  
endurance

**Çift yönlü kullanım  
sağlayan mandal tasarımı**  
Bi-directional latch design

**Yüksek mukavemetli  
alaşımli sıcak dövme çeliği**  
High strength alloyed cold work  
tool steel

**Nikel üzerine krom  
kaplama ile korozyon  
direncinde üst seviye koruma**  
High corrosion resistance with  
chrome over nickel plating

**Dayanımı yüksek sert plastikten ve  
konforlu tutuş sağlayan yumuşak  
elastomer malzemeden imal edilmiş çift  
komponentli ergonomik sap**  
Two component ergonomic handle with high  
strength and soft grip plastic



İZELTAS USTA İŞİ  
SOHBETLER



İZELTAS YOUTUBE

# HAVALI LOKMA GRUBU

IMPACT SOCKET

- Havalı Lokma Anahtarlar  
Impact Socket Wrenches



**3/8" Altı Köşe Havalı Lokma Anahtar (mm)**  
Impact Socket Wrench 6 Points (mm)

TS ISO 2725-2

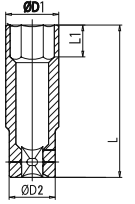
**3/8" Altı Köşe Havalı Derin Lokma Anahtar (mm)**  
Impact Socket Wrench 6 Points Long Type (mm)**3/8"****Krom molibden, Fosfat kaplamalı**  
Chrom molybdenum, Phosphate finish**3/8"****Krom molibden, Fosfat kaplamalı**  
Chrom molybdenum, Phosphate finish

KOD CODE	Ø mm	Ø D1 mm	Ø D2 mm	L mm	L1 mm	g	TL/ Ad.	
14000 004583	6	10.6	19	32	5	35	10	201,25
14000 004584	7	11.8	19	32	5	35	10	201,25
14000 004585	8	13.2	19	32	6	35	10	201,25
14000 004586	9	14.5	19	32	6	35	10	201,25
14000 004587	10	15.5	19	32	7	40	10	201,25
14000 004588	11	17	19	32	7	40	10	201,25
14000 004589	12	18.2	19	32	8	40	10	201,25
14000 004590	13	19.4	22	32	9	55	10	209,50
14000 004591	14	20.7	22	32	9	55	10	209,50
14000 004592	15	22	22	32	10	55	10	238,50
14000 004593	16	23.8	22	32	10	60	10	238,50
14000 004594	17	24.8	22	32	11	60	10	238,50
14000 004595	18	25.8	22	32	11	60	10	238,50
14000 004596	19	27.6	22	32	13	65	10	268,25
14000 004597	20	28.3	22	32	13	70	10	276,50
14000 004598	21	29.5	22	32	13	75	10	283,50
14000 004599	22	30.8	22	32	13	85	10	320,50
14000 004600	23	32	22	32	13	90	10	320,50

KOD CODE	Ø mm	Ø D1 mm	Ø D2 mm	L mm	L1 mm	g	TL/ Ad.	
14000 004601	6	10.6	19	65	10	50	10	386,00
14000 004602	7	11.8	19	65	10	55	10	386,00
14000 004603	8	13.2	19	65	12	70	10	386,00
14000 004604	9	14.5	19	65	12	65	10	386,00
14000 004605	10	15.5	19	65	12	80	10	386,00
114000 004606	11	17	19	65	13	75	10	386,00
14000 004607	12	18.2	19	65	14	90	10	386,00
14000 004608	13	19.4	22	65	14	100	10	402,50
14000 004609	14	20.7	22	65	14	110	10	402,50
14000 004610	15	22	22	65	16	115	10	412,00
14000 004611	16	23.8	22	65	16	125	10	412,00
14000 004612	17	24.8	22	65	17	140	10	461,25
14000 004613	18	25.8	22	65	18	140	10	469,50
14000 004614	19	27.6	22	65	20	150	10	469,50
14000 004615	20	28.3	22	65	20	155	10	488,50
14000 004616	21	29.5	22	65	22	160	10	490,00
14000 004617	22	30.8	22	65	22	180	10	490,00
14000 004618	23	32	22	65	24	180	10	514,50



### 3/8" Havalı Lokma Ara Kol Impact Socket Extension Bar

TS ISO 1174-2

**3/8"**

 Krom molibden, Fosfat kaplamalı  
Chrom molybdenum, Phosphate finish

KOD CODE	L mm	g	□	TL/Ad.
14000 004619	75	95	10	434,00
14000 004620	125	145	10	574,75

### 14000 004621

### 3/8" Havalı Lokma Adaptör Impact Socket Adapter

**3/8"**

 Krom molibden, Fosfat kaplamalı  
Chrom molybdenum, Phosphate finish

KOD CODE	inch	g	□	TL/Ad.
14000 004621	3/8"Fx1/2"M	50	10	312,25

### 14000 004622

### 3/8" Havalı Lokma Mafsals Impact Socket Universal Joint

**3/8"**

 Krom molibden, Fosfat kaplamalı  
Chrom molybdenum, Phosphate finish

KOD CODE	inch	g	□	TL/Ad.
14000 004622	3/8"	85	10	938,75

### 1113 00 9003

### 1/2" Alaşımli Jant Lokma Takımı (3 Parça, mm) Lug Nut Socket Wrench 6 Points (3 Pcs, mm)

**1/2"**

KOD CODE	LOKMA LAR Sockets	g	□	TL/Ad.
1113 00 9003	17 - 19 - 21	840	3	2.342,25

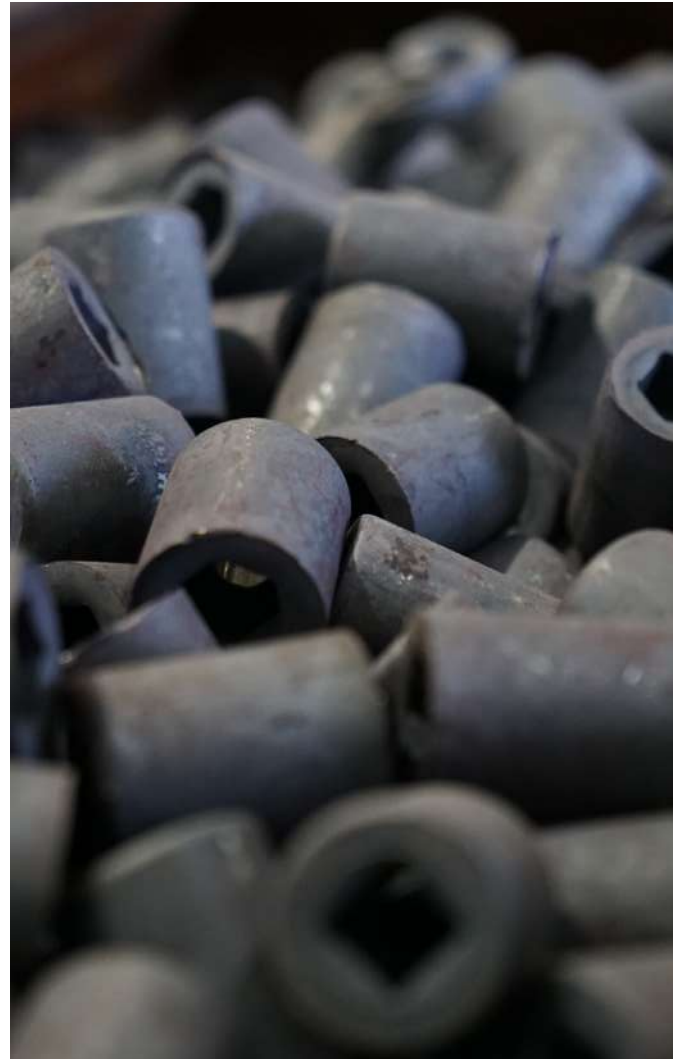

1113

**1/2" Altı Köşe Havalı Lokma Anahtar (mm)**  
Impact Socket Wrench 6 Points (mm)

TS ISO 2725-2



İZELTAS YOUTUBE

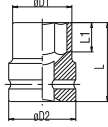

1/2"

Krom molibden, Fosfat kaplamalı  
Chrom molybdenum, Phosphate finish

KOD CODE	mm	σ D1 mm	σ D2 mm	L mm	L1 mm	g	TL/ Ad.
1113 06 7008	8	15	25	38	7	60	10 202,75
1113 06 7009	9	16.5	25	38	7	70	10 202,75
1113 06 7010	10	17.6	25	38	8	70	10 205,25
1113 06 7011	11	18.8	25	38	8	70	10 205,25
1113 06 7012	12	20	25	38	9	70	10 205,25
1113 06 7013	13	21.2	25	38	10	75	10 220,50
1113 06 7014	14	22.5	25	38	10	75	10 220,50
1113 06 7015	15	23.8	30	38	11	115	10 253,25
1113 06 7016	16	25	30	38	11	115	10 264,25
1113 06 7017	17	26.2	30	38	12	110	10 265,75
1113 06 7018	18	27.5	30	38	13	120	10 265,75
1113 06 7019	19	28.8	30	38	13	120	10 271,25
1113 06 7020	20	29.5	30	38	13	115	10 283,50
1113 06 7021	21	30	30	40	14	120	10 286,25
1113 06 7022	22	32.4	30	40	14	130	10 326,00
1113 06 7023	23	33.2	30	40	15	130	10 341,00
1113 06 7024	24	34.4	30	42	15	140	10 338,25
1113 06 7025	25	36	30	42	15	155	10 398,25
1113 06 7026	26	37	30	42	15	175	10 402,50
1113 06 7027	27	37.8	30	44	16	165	10 428,50
1113 06 7028	28	39.8	30	44	16	210	10 459,75
1113 06 7029	29	39.8	30	44	17	200	10 466,75
1113 06 7030	30	41.8	30	44	17	205	10 500,75
1113 06 7032	32	46	30	44	19	235	10 546,25

1108

**1/2" Altı Köşe Havalı Derin Lokma Anahtar (mm)** TS ISO 2725-2  
Impact Socket Wrench 6 Point, Long Type (mm)

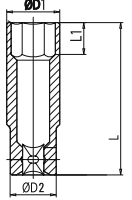

1/2"

Krom molibden, Fosfat kaplamalı  
Chrom molybdenum, Phosphate finish

KOD CODE	mm	σ D1 mm	σ D2 mm	L mm	L1 mm	g	TL/ Ad.
1108 06 7008	8	15	24.8	78	12	130	10 388,75
1108 06 7009	9	16.3	24.8	78	12	235	10 388,75
1108 06 7010	10	17.6	24.8	80	12	20	10 390,00
1108 06 7011	11	18.8	24.8	80	13	20	10 390,00
1108 06 7012	12	20	24.8	80	14	20	10 390,00
1108 06 7013	13	21.2	24.8	80	14	20	10 423,00
1108 06 7014	14	22.5	24.8	80	14	25	10 423,00
1108 06 7015	15	23.8	29.8	80	16	25	10 472,00
1108 06 7016	16	25	29.8	80	16	25	10 472,00
1108 06 7017	17	26.2	29.8	80	16	235	10 472,00
1108 06 7018	18	27.5	29.8	80	17	245	10 472,00
1108 06 7019	19	28.8	29.8	80	18	255	10 472,00
1108 06 7020	20	29	29.8	80	20	250	10 490,00
1108 06 7021	21	29.8	29.8	80	20	275	10 492,50
1108 06 7022	22	32.4	30	80	22	275	10 492,50
1108 06 7023	23	33.2	30	80	24	295	10 516,00
1108 06 7024	24	34.4	30	80	24	295	10 520,00
1108 06 7025	25	36	30	80	24	325	10 610,25
1108 06 7026	26	37	30	80	27	345	10 617,25
1108 06 7027	27	37.8	30	80	27	345	10 687,00
1108 06 7028	28	39.8	30	80	27	425	10 691,00
1108 06 7029	29	39.8	30	80	27	420	10 691,00
1108 06 7030	30	41.8	30	80	30	500	10 770,50
1108 06 7032	32	46	30	80	32	495	10 821,00

**1/2" Havalı Star (Torx®) Lokma Anahtar**  
Impact Socket Star (Torx®) Wrench

Krom molibden, Fosfat kaplamalı  
Chrom molybdenum, Phosphate finish

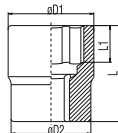

1/2"

KOD CODE	mm	σ D1 mm	σ D2 mm	L mm	L1 mm	g	TL/ Ad.
14000 004539	E10	14	25	38	7.5	65	10 402,50
14000 005160	E12	15.9	25	38	9	70	10 402,50
14000 004540	E14	17.7	25	38	10	75	10 402,50
14000 004541	E16	20	25	38	11	80	10 402,50
14000 004542	E18	22	25	38	12.5	80	10 450,50
14000 004543	E20	24.5	30	38	14	120	10 481,75
14000 004544	E22	26	30	38	15	125	10 524,25
14000 004545	E24	28	30	38	16	130	10 546,25

## 1/2" Havalı Allen Uç Lokma Anahtar

### Impact Socket Hexagonal Bits Socket Wrench

**1/2"**

Krom molibden, Fosfat kaplamalı  
Chrom molybdenum, Phosphate finish

KOD CODE	mm	L mm	g		TL/Ad.
14000 004546	H4	80	70	10	514,50
14000 004547	H5	80	70	10	514,50
14000 004548	H6	80	80	10	514,50
14000 004549	H8	80	85	10	562,50
14000 004550	H10	80	100	10	562,50
14000 004551	H12	80	120	10	562,50
14000 004552	H14	80	145	10	562,50
14000 004553	H17	80	220	10	595,25
14000 004554	H19	80	245	10	707,50

## 1/2" Havalı Star (Torx®) Uç Lokma Anahtar

### Impact Socket Star (Torx®) Bits Socket Wrench

**1/2"**

Krom molibden, Fosfat kaplamalı  
Chrom molybdenum, Phosphate finish

KOD CODE		L mm	g		TL/Ad.
14000 004573	T20	100	70	10	595,25
14000 004574	T25	100	75	10	595,25
14000 004575	T27	100	75	10	595,25
14000 004576	T30	100	80	10	595,25
14000 004577	T40	100	80	10	595,25
14000 004578	T45	100	90	10	610,25
14000 004579	T50	100	95	10	626,75
14000 004580	T55	100	115	10	626,75
14000 004581	T60	100	140	10	626,75
14000 004582	T80	100	195	10	707,50

## 1513 06 7125

## 1/2" Havalı Lokma Ara Kol

### Impact Socket Extension Bar

TS ISO 1174-2

**1/2"**

Krom molibden, Fosfat kaplamalı  
Chrom molybdenum, Phosphate finish

KOD CODE	L mm	g		TL/Ad.
1513 06 7125	125	280	5	776,00

## 1513

## 1/2" Havalı Lokma Adaptörü

### Impact Socket Adapter

**1/2"**

Krom molibden, Fosfat kaplamalı  
Chrom molybdenum, Phosphate finish

KOD CODE	inch	g		TL/Ad.
1513 06 7002	1/2"Fx3/8"M	50	5	513,00
1513 06 7003	1/2"Fx3/4"M	150	5	585,75

## 1513 06 7075

## 1/2" Havalı Lokma Mafsalsal

### Impact Socket Universal Joint

**1/2"**

Krom molibden, Fosfat kaplamalı  
Chrom molybdenum, Phosphate finish

KOD CODE	L mm	g		TL/Ad.
1513 06 7075	75	215	5	985,00

1119

**3/4" Altı Köşe Havali Lokma Anahtar (mm)**  
Impact Socket Wrench 6 Points (mm)

TS ISO 2725-2

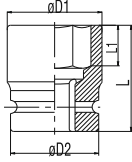

**Krom molibden, Fosfat kaplamalı**  
Chrom molybdenum, Phosphate finish

KOD CODE	mm	σ D1 mm	σ D2 mm	L mm	L1 mm	g	TL/Ad.
1119 06 7017	17	29	44	50	10	305	5 772,00
1119 06 7018	18	30	44	50	10	310	5 772,00
1119 06 7019	19	32	44	50	10	325	5 772,00
1119 06 7020	20	33	44	50	10	325	5 772,00
1119 06 7021	21	35	44	50	13	335	5 772,00
1119 06 7022	22	36	44	50	13	340	5 772,00
1119 06 7023	23	37	44	50	15	340	5 772,00
1119 06 7024	24	38	44	50	15	340	5 772,00
1119 06 7025	25	41	44	53	15	375	5 772,00
1119 06 7026	26	40	44	53	15	365	5 772,00
1119 06 7027	27	42	44	53	18	370	5 772,00
1119 06 7028	28	44	44	53	18	390	5 772,00
1119 06 7029	29	45	44	53	18	400	5 772,00
1119 06 7030	30	46	44	53	20	410	1 772,00
1119 06 7032	32	48	44	57	20	455	1 772,00
1119 06 7033	33	50	44	57	20	490	1 867,75
1119 06 7034	34	51	44	57	22	495	1 992,00
1119 06 7035	35	53	44	57	22	500	1 884,00
1119 06 7036	36	53	44	57	22	500	1 992,00
1119 06 7038	38	56	44	57	22	545	1 963,50
1119 06 7041	41	59	44	58	24	590	1 1.531,25
1119 06 7044	44	64	44	62	24	705	1 1.620,00
1119 06 7046	46	66	44	62	24	780	1 1.627,00
1119 06 7050	50	71	44	65	26	890	1 1.862,00
1119 06 7055	55	77	54	70	30	1175	1 2.119,50
1119 06 7060	60	84	54	70	32	1395	1 2.600,75

**3/4" Altı Köşe Havali Derin Lokma Anahtar (mm)** TS ISO 2725-2  
Impact Socket Wrench 6 Points, Long Type (mm)

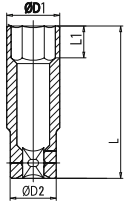

**Krom molibden, Fosfat kaplamalı**  
Chrom molybdenum, Phosphate finish

KOD CODE	mm	σ D1 mm	σ D2 mm	L mm	L1 mm	g	TL/Ad.
14000 004504	17	29	44	90	15	525	5 1.172,50
14000 004505	18	30	44	90	15	525	5 1.172,50
14000 004506	19	32	44	90	16	560	5 1.172,50
14000 004507	20	32	44	90	17	570	5 1.172,50
14000 004508	21	35	44	90	18	595	5 1.172,50
14000 004509	22	36	44	90	18	610	5 1.172,50
14000 004510	23	37	44	90	23	595	5 1.172,50
14000 004511	24	38	44	90	23	625	5 1.172,50
14000 004512	25	40	44	90	25	615	5 1.172,50
14000 004513	26	40	44	90	25	615	5 1.172,50
14000 004514	27	42	44	90	27	625	5 1.172,50
14000 004515	28	44	44	90	27	665	5 1.204,00
14000 004516	29	45	44	90	27	680	5 1.220,50
14000 004517	30	46	44	90	27	670	1 1.220,50
14000 004518	32	48	44	90	30	740	1 1.220,50
14000 004519	33	50	44	90	30	795	1 1.316,25
14000 004520	34	51	44	90	32	790	1 1.365,50
14000 004521	35	52	44	90	32	785	1 1.477,50
14000 004522	36	53	44	90	32	820	1 1.477,50
14000 004523	38	56	44	90	34	875	1 1.637,75
14000 004524	41	59	44	90	34	940	1 1.959,25
14000 004525	46	66	44	95	38	1225	1 2.150,75
14000 004526	50	71	44	95	40	1285	1 2.681,50
14000 004527	55	77	54	100	45	1805	1 3.207,00

**3/4" Havali Allen Uç Lokma Anahtar (mm)**  
Impact Socket Hexagonal Bits Socket Wrench (mm)

**Krom molibden, Fosfat kaplamalı**  
Chrom molybdenum, Phosphate finish



KOD CODE	mm	L mm	g	TL/Ad.
14000 004528	H14	87	310	5 1.878,50
14000 004529	H17	87	345	5 1.878,50
14000 004530	H19	87	365	5 1.878,50
14000 004531	H21	87	510	5 1.878,50
14000 004532	H22	87	525	5 1.878,50
14000 004533	H24	87	555	5 2.023,50
14000 004534	H27	87	605	5 2.023,50
14000 004535	H30	87	690	1 2.023,50
14000 004536	H32	87	735	1 2.231,50
14000 004537	H36	87	810	1 2.312,00

**1519**
**3/4" Havalı Lokma Ara Kol**  
 Impact Socket Extension Bar

TS ISO 1174-2

**3/4"**

 Krom molibden, Fosfat kaplamalı  
 Chrom molybdenum, Phosphate finish

KOD CODE	L mm	g	TL/ Ad.
1519 06 7175	175	845	5 1.691,00
1519 06 7250	250	1125	5 2.417,50
1519 06 7330	330	1465	5 3.667,75

**1519**
**3/4" Havalı Lokma Adaptörü**  
 Impact Socket Adapter

**3/4"**

 Krom molibden, Fosfat kaplamalı  
 Chrom molybdenum, Phosphate finish

KOD CODE	inch	g	TL/ Ad.
1519 06 7011	3/4"Fx1/2"M	315	5 977,00
1519 06 7012	3/4"Fx1"M	445	5 1.268,25

**1519 06 7108**
**3/4" Havalı Lokma Mafsals**  
 Impact Socket Universal Joint

**3/4"**

 Krom molibden, Fosfat kaplamalı  
 Chrom molybdenum, Phosphate finish

KOD CODE	L mm	g	TL/ Ad.
1519 06 7108	108	745	5 2.815,75





1125

**1" Altı Köşe Havali Lokma Anahtar (mm)**  
Impact Socket Wrench 6 Points (mm)

TS ISO 2725-2



1"

**Krom molibden, Fosfat kaplamalı**  
Chrom molybdenum, Phosphate finish

KOD CODE	Ø mm	σ D1 mm	σ D2 mm	L mm	L1 mm	g	TL/Ad.
1125 06 7021	21	37	54	58	15	530	1 1.139,75
1125 06 7022	22	38	54	58	15	545	1 1.139,75
1125 06 7023	23	39	54	58	17	540	1 1.139,75
1125 06 7024	24	41	54	58	17	580	1 1.139,75
1125 06 7025	25	42	54	58	17	560	1 1.139,75
1125 06 7026	26	43	54	58	19	565	1 1.139,75
1125 06 7027	27	44	54	58	19	580	1 1.139,75
1125 06 7028	28	45	54	58	19	565	1 1.139,75
1125 06 7029	29	47	54	58	19	590	1 1.139,75
1125 06 7030	30	48	54	60	20	660	1 1.257,50
1125 06 7032	32	51	54	62	20	675	1 1.272,25
1125 06 7033	33	52	54	62	20	655	1 1.272,25
1125 06 7034	34	53	54	62	20	655	1 1.279,25
1125 06 7035	35	54	54	62	20	655	1 1.282,00
1125 06 7036	36	56	54	65	20	745	1 1.285,00
1125 06 7038	38	58	54	65	22	730	1 1.338,25
1125 06 7041	41	61	54	70	22	850	1 1.631,00
1125 06 7046	46	68	54	75	26	1065	1 1.798,00
1125 06 7048	48	70	54	75	26	1077	1 1.918,25
1125 06 7050	50	73	54	75	26	1165	1 1.918,25
1125 06 7055	55	79	54	83	32	1495	1 2.542,00
1125 06 7060	60	86	54	87	32	1640	1 3.178,25
1125 06 7065	65	92	54	90	34	1900	1 3.531,00
1125 06 7070	70	97	54	93	34	2090	1 4.654,25
1125 06 7075	75	104	86	95	36	3150	1 6.258,75
1125 06 7080	80	110	86	95	43	3430	1 7.222,00
1125 06 7085	85	115	86	95	43	3445	1 9.629,75
1125 06 7090	90	122	86	100	43	4080	1 11.716,00

**1" Altı Köşe Havali Derin Lokma Anahtar (mm)**  
Impact Socket Wrench 6 Points, Long Type (mm)

TS ISO 2725-2

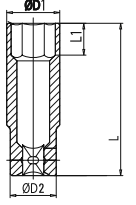

1"

**Krom molibden, Fosfat kaplamalı**  
Chrom molybdenum, Phosphate finish

KOD CODE	Ø mm	σ D1 mm	σ D2 mm	L mm	L1 mm	g	TL/Ad.
14000 004462	21	38	54	90	25	840	1 1.573,25
14000 004463	22	39	54	90	25	845	1 1.573,25
14000 004464	23	40	54	90	25	830	1 1.573,25
14000 004465	24	41	54	90	25	870	1 1.573,25
14000 004466	25	42	54	90	25	880	1 1.573,25
14000 004467	26	43	54	90	25	865	1 1.573,25
14000 004468	27	44	54	90	25	865	1 1.573,25
14000 004469	28	45	54	90	25	900	1 1.606,50
14000 004470	29	47	54	90	15	950	1 1.606,50
14000 004471	30	48	54	90	28	905	1 1.606,50
14000 004472	32	51	54	90	28	960	1 1.730,75
14000 004473	33	51	54	92	28	990	1 1.730,75
14000 004474	34	53	54	92	28	990	1 1.798,00
14000 004475	35	54	54	92	28	1035	1 1.910,00
14000 004476	36	56	54	92	32	1040	1 1.910,00
14000 004477	38	58	54	92	32	1050	1 2.183,50
14000 004478	41	61	54	92	32	1100	1 2.343,75
14000 004479	46	68	54	95	35	1335	1 2.696,50
14000 004480	50	73	54	95	35	1485	1 3.211,00
14000 004481	55	70	54	100	40	1770	1 4.172,50
14000 004482	60	86	54	100	42	20320	1 5.457,25
14000 004483	65	92	54	110	50	2140	1 7.093,25
14000 004484	70	97	54	110	59	2335	1 9.019,50
14000 004485	75	104	86	120	60	3410	1 10.656,75
14000 004486	80	110	86	120	60	4220	1 12.229,00
14000 004487	85	115	86	120	60	4770	1 20.060,75
14000 004488	90	122	86	125	65	5330	1 23.269,75



**1525**
**1" Havalı Lokma Ara Kol**  
 Impact Socket Extension Bar

TS ISO 1174-2

**1"**

 Krom molibden, Fosfat kaplamalı  
 Chrom molybdenum, Phosphate finish

KOD CODE	L mm	g	TL/Ad.
1525 06 7175	175	1420	5 3.083,75
1525 06 7250	250	1930	5 3.962,00
1525 06 7330	330	2445	5 4.815,50

**1525 06 7128**
**1" Havalı Lokma Mafsal**  
 Impact Socket Universal Joint

**1"**

 Krom molibden, Fosfat kaplamalı  
 Chrom molybdenum, Phosphate finish

KOD CODE	L mm	g	TL/Ad.
1525 06 7128	128	1495	1 5.748,50

**1525 06 7015**
**1" Havalı Lokma Adaptörü**  
 Impact Socket Adapter

**1"**

 Krom molibden, Fosfat kaplamalı  
 Chrom molybdenum, Phosphate finish

KOD CODE	inch	g	TL/Ad.
1525 06 7015	1"Fx3/4" M	180	5 1.181,00





# BORU ANAHTARLARI VE PENSELER

PIPE WRENCHES AND PLIERS

- Boru Anahtarları  
Pipe Wrenches
- Fort Penseler  
Water Pump Pliers
- Ayarlı Penseler  
Grip Wrenches
- Penseler  
Pliers
- Kargaburunlar  
Long Nose Pliers
- Yan Keskiller  
Side Cutters
- Segman Penseler  
Circlip Pliers
- Özel Amaçlı Penseler  
Special Pliers
- Elektronikçi Penseler  
Electronic Pliers
- Kerpetenler  
Carpenter Pincers





## KOMBİNE PENSE BLACK LINE SERİ / COMBINATION PLIERS

**Güçlü kavrama sağlayan  
tırnaklı tutma yüzeyleri**  
Toothed surface for strong grip

**Isıl işlem sonrasında indüksiyonda  
sertleştirme ile kullanım ömrü  
artırılmış kesici ağızlar**  
Heat-treated and induction hardened  
cutting edges for long lifetime

**Siyah fosfat kaplama ile  
korozyon direnci**  
High corrosion resistance  
with manganese phosphate coating

**Yüksek karbonlu  
sıcak dövme çeliği  
ile artırılmış  
dayanım**  
High carbon forged  
steel for improved  
durability

**Düşmelere ve darbeye dayanıklı,  
P.P. ergonomik sap**  
Impact resistant P.P. handle



2100

**Stilson Boru Anahtarı**  
 Pipe Wrench, Stilson

TS 3796



 Yedek parça sayfa 255-259  
 Spare parts page 255-259

 Krom vanadyum, Dişler indüksiyonda sertleştirilmiş, Elektrostatik boyanmış  
 Chrom vanadium, Teeth induction hardened, Electrostatically painted

KOD CODE	L mm	L inch	mm	ÖLÇÜ SIZE mm	g	TL/Ad.
2100 10 0008	200	8"	27	6-20	290	1 1.376,50
2100 10 0010	250	10"	34	6-26	560	1 1.655,50
2100 10 0012	300	12"	42	10-32	755	1 1.862,00
2100 10 0014	350	14"	50	13-38	1130	1 2.286,00
2100 10 0018	450	18"	60	26-52	1795	1 2.901,75
2100 10 0024	600	24"	76	38-65	3065	1 4.671,75

2201

**Maşalı Boru Anahtarı (85°)**  
 Pipe Wrench (85°)

 TS 3796  
 DIN 5234

 Yedek parça sayfa 255-259  
 Spare parts page 255-259

 Krom vanadyum, Dişler indüksiyonda sertleştirilmiş, Elektrostatik boyanmış  
 Chrom vanadium, Teeth induction hardened, Electrostatically painted

KOD CODE	L mm	mm	ÖLÇÜ SIZE Inch	g	TL/Ad.
2201 10 0010	325	40	1"	840	1 1.401,25
2201 10 0015	430	55	1 1/2"	1495	1 2.169,75
2201 10 0020	585	67	2"	2770	1 3.248,00
2201 10 0030	690	103	3"	4210	1 4.922,25
2201 10 0040	760	121	4"	5800	1 7.382,00

2110

**Ağır Tip Boru Anahtarı**  
 Pipe Wrench, Heavy Duty

 Yedek parça sayfa 255-259  
 Spare parts page 255-259

 Krom vanadyum, Dişler indüksiyonda sertleştirilmiş, Elektrostatik boyanmış  
 Chrom vanadium, Teeth induction hardened, Electrostatically painted

KOD CODE	L mm	L inch	mm	ÖLÇÜ SIZE Inch	g	TL/Ad.
2110 10 0008	200	8"	34	1"	415	1 1.827,75
2110 10 0010	250	10"	42	1 1/4"	810	1 2.268,50
2110 10 0012	300	12"	50	1 1/2"	1290	1 2.596,75
2110 10 0014	350	14"	60	2"	1665	1 3.023,50
2110 10 0018	450	18"	75	2 1/2"	2750	1 4.217,75
2110 10 0024	600	24"	90	3"	4235	1 6.800,50
2110 10 0036	900	36"	140	5"	7380	1 15.060,75
2110 10 0048	1200	48"	165	6"	15315	1 30.843,00

**Zincirli Boru Anahtarı**  
 Chain Pipe Wrench

 Yedek parça sayfa 255-259  
 Spare parts page 255-259

 Dişler indüksiyonda sertleştirilmiş, Elektrostatik boyanmış  
 Teeth induction hardened, Electrostatically painted

KOD CODE	L mm	mm	ÖLÇÜ SIZE Inch	g	TL/Ad.
14000 005036	940	115	4"	4770	1 11.234,25
14000 005037	1125	165	6"	8780	1 15.246,50
14000 005140	1280	220	8"	13185	1 25.677,50



**Zincirli Boru Anahtarı Yedek Zinciri**  
 Spare Chain For Chain Pipe Wrench

KOD CODE	ÖLÇÜ SIZE Inch	L mm	g	TL/Ad.
14000 005039	4"	555	840	1 2.761,00
14000 005038	6"	785	2285	1 4.815,50
14000 005139	8"	990	2855	1 5.617,25



**2400****Üniversal Fort Pense**  
Waterpump Pliers UniversalTS 60 TS ISO 8976  
DIN ISO 8976

IZELTAS YOUTUBE



**Krom vanadyum, Krom kaplı, PVC izoleli**  
Chrom vanadium, Chrom plated, PVC insulated

KOD CODE	L mm	L inch	 mm	 g		TL/Ad.
2400 11 0160	160	6 1/4"	30	135	5	859,50
2400 11 0240	240	9 1/2"	35	320	5	1.200,00
2400 11 0315	315	12 1/2"	40	640	5	1.964,75

**2400 11 6240****1000V İzoleli Üniversal Fort Pense**  
Insulated Type Waterpump  
Pliers Universal 1000VTS 60  
TS ISO 8976  
△ 1000 V  
IEC 60900**Krom vanadyum, Krom kaplı, Çift komponent saplı**  
Chrom vanadium, Chrom plated, Two component handle

KOD CODE	L mm	L inch	 mm	 g		TL/Ad.
2400 11 6240	240	9 1/2"	35	375	5	1.393,00

**2415 11 0240****Yaylı Fort Pense**  
Waterpump Pliers With Spring**YENİ TASARIM**  
NEW DESIGNIZELTAS USTA İŞİ  
SOHBETLER**Karartma, PVC izoleli**  
Black finish, PVC insulated

KOD CODE	L mm	L inch	 mm	 g		TL/Ad.
2415 11 0240	240	9 1/2"	43	355	5	1.618,75



**2500 11 0250**
**Üniversal Ayarlı Pense**  
 Universal Grip

Çeneler krom vanadyum çeliğinden dövülmüştür, Nikel kaplama,  
 Kullanım sahası: Yuvarlak ve düz malzemeler  
 Jaws Chrom vanadium forged, Nickel plated  
 Application field: Flat and round materials

KOD CODE	L mm	L inch	mm	g	TL/ Ad.
2500 11 0250	250	10"	30	515	5 1.429,75

**2510 11 0250**
**Spesiyal Ayarlı Pense**  
 Special Grip

Çeneler krom vanadyum çeliğinden dövülmüştür, Nikel kaplama,  
 Kullanım sahası: Yuvarlak ve düz malzemeler  
 Jaws Chrom vanadium forged, Nickel plated  
 Application field: Flat and round materials

KOD CODE	L mm	L inch	mm	g	TL/ Ad.
2510 11 0250	250	10"	30	520	5 1.429,75

**2505 11 0250**
**Standart Ayarlı Pense**  
 Standard Grip

TSEK



Çeneler krom vanadyum çeliğinden dövülmüştür, Nikel kaplama  
 Kullanım sahası: Düz malzemeler  
 Jaws, Chrom vanadium forged, Nickel plated  
 Application field: Flat materials

KOD CODE	L mm	L inch	mm	g	TL/ Ad.
2505 11 0250	250	10"	30	525	5 1.429,75

**2511 11 0280**
**C Tipi Ayarlı Pense**  
 Clamp Grip C-type

Çeneler krom vanadyum çeliğinden dövülmüştür, Nikel kaplama,  
 Kullanım sahası: Açılı profillerin tutulmasında  
 Jaws Chrom vanadium forged, Nickel plated  
 Application field: For Gripping angled sheet metal

KOD CODE	L mm	L inch	mm	g	TL/ Ad.
2511 11 0280	280	11"	70	590	1 2.388,75

**2512 11 0200****Kaynakçı Ayarlı Pense (Düz Ağız)**  
Lock Grip With Flat Jaws

Özel alaşımlı çelikten imal edilmiş, Nikel kaplama,  
Kullanım sahası: 80 mm düz çeneleri ile kıvrık metal levhaları  
Made from special alloy steel, Nickel plated,  
Application field: Gripping sheet metals with 80 mm Flat jaws

KOD CODE	L mm	L inch	mm	g	TL/Ad.
2512 11 0200	200	8"	30	490	1 2.410,75

**2515 11 0270****Kaportacı Ayarlı Pense**  
Welding Grip

Özel alaşımlı çelikten imal edilmiş- Nikel kaplama,  
Kullanım sahası: Yassı ve köşeli malzemelerde  
Made from special alloy steel, Nickel plated  
Application field: Angled corners and edges

KOD CODE	L mm	L inch	mm	g	TL/Ad.
2515 11 0270	270	10 5/8"	50	755	1 1.914,25

**2513 11 0280****Kaynakçı Ayarlı Pense (Boru İçin)**  
Grip For Tubes

Özel alaşımlı çelikten imal edilmiş, Nikel kaplama,  
Kullanım sahası: Boru malzemeler  
Made from special alloy steel, Nickel plated,  
Application field: Tubes

KOD CODE	L mm	L inch	mm	g	TL/Ad.
2513 11 0280	280	11"	50	775	1 2.410,75

**3020****Kombine Pense Opak Seri**  
Combination Pliers

TS 60  
TS ISO 5746  
DIN ISO 5746



IZELTAS YOUTUBE

Özel alaşımlı çelik, Kesici ağızlar indüksiyonda sertleştirilmiş  
Special steel, Cutters induction hardened

KOD CODE	L mm	L inch	g	TL/Ad.
3020 12 2160	160	6 1/4"	205	5 747,00
3020 12 2180	180	7 1/8"	260	5 847,25
3020 12 2200	200	8"	355	5 955,25

3020

**Kombine Pense Kraft Seri**  
 Combination Pliers

 TS 60  
 TS ISO 5746  
 DIN ISO 5746

 Özel alaşımlı çelik, Kesici ağızlar indüksiyonda sertleştirilmiş  
 Special steel, Cutters induction hardened

KOD CODE	L mm	L inch	g	□	TL/Ad.
3020 12 3160	160	6 1/4"	220	5	914,00
3020 12 3180	180	7 1/8"	285	5	1.022,25
3020 12 3200	200	8"	365	5	1.155,00

13000 005118

**Kombine Pense Black Line**  
 Combination Pliers

 TS 60  
 TS ISO 5746  
 DIN ISO 5746

 Özel alaşımlı çelik, Mangan fosfat kaplı,  
 Kesici ağızlar indüksiyonda sertleştirilmiş  
 Special steel, Phosphate finish, Cutters induction hardened

KOD CODE	L mm	L inch	g	□	TL/Ad.
13000 005118	180	7 1/8"	290	5	1.237,00

3020

**1000V İzoleli Elektrikçi Kombine Pense**  
 Electrician Type Insulated  
 Combination Pliers 1000V

 TS 60  
 TS ISO 5746  
 DIN ISO 5746  
 ⚡ 1000 V  
 IEC 60900

 Özel alaşımlı çelik, Kesici ağızlar indüksiyonda sertleştirilmiş, Krom kaplı  
 Special steel, Cutters induction hardened, Chrom plated

KOD CODE	L mm	L inch	g	□	TL/Ad.
3020 12 6160	160	6 1/4"	210	5	1.026,00
3020 12 6180	180	7 1/8"	260	5	1.100,25
3020 12 6200	200	8"	350	5	1.241,00

3030

**Kombine Pense Ağır Tip (çelik tel için)**  
 Combination Pliers Heavy Duty  
 (for piano wire)

 Özel alaşımlı çelik, Kesici ağızlar indüksiyonda sertleştirilmiş,  
 Special steel, Cutters induction hardened

KOD CODE	L mm	L inch	g	□	TL/Ad.
3030 12 2180	180	7 1/8"	260	5	1.275,25
3030 12 2200	200	8"	345	5	1.458,50

**3220****Kargaburun Düz Uçlu Opak Seri**  
Long Nose Pliers (Flat)TS 60 - TS ISO 5745  
DIN ISO 5745

İZELTAS YOUTUBE

Özel alaşımli çelik, Kesici ağızlar indüksiyonda sertleştirilmiş  
Special steel, Cutters induction hardened

KOD CODE	L mm	L inch	g	□	TL/Ad.
3220 13 2140	140	5 1/2"	100	5	734,75
3220 13 2160	160	6 1/4"	140	5	832,00
3220 13 2180	180	7 1/8"	165	5	914,00
3220 13 2200	200	8"	170	5	968,75

**3220****Kargaburun Düz Uçlu Kraft Seri**  
Long Nose Pliers (Flat)TS 60 - TS ISO 5745  
DIN ISO 5745Özel alaşımli çelik, Kesici ağızlar indüksiyonda sertleştirilmiş  
Special steel, Cutters induction hardened

KOD CODE	L mm	L inch	g	□	TL/Ad.
3220 13 3140	140	5 1/2"	110	5	907,25
3220 13 3160	160	6 1/4"	145	5	1.023,50
3220 13 3180	180	7 1/8"	175	5	1.126,25
3220 13 3200	200	8"	185	5	1.194,50

**3220****1000V İzoleli Elektrikçi Kargaburun Düz Uçlu**  
Insulated Electrician Type  
Long Nose Pliers 1000VTS 60  
TS ISO 5745  
DIN ISO 5745  
△ 1000 V  
IEC 60900Özel alaşımli çelik, Kesici ağızlar indüksiyonda sertleştirilmiş, Krom kaplı  
Special steel, Cutters induction hardened, Chrom plated

KOD CODE	L mm	L inch	g	□	TL/Ad.
3220 13 6140	140	5 1/2"	100	5	1.051,00
3220 13 6160	160	6 1/4"	130	5	1.161,75
3220 13 6180	180	7 1/8"	160	5	1.304,00
3220 13 6200	200	8"	170	5	1.354,50

**13000 005117****Kargaburun Düz Uçlu Black Line**  
Long Nose Pliers (Flat)TS 60 - TS ISO 5745  
DIN ISO 5745Özel alaşımli çelik, Manganoz fosfat kaplı,  
Kesici ağızlar indüksiyonda sertleştirilmiş  
Special steel, Phosphate finish, Cutters induction hardened

KOD CODE	L mm	L inch	g	□	TL/Ad.
13000 005117	180	7 1/8"	170	5	1.468,25

3225

**Kargaburun Eğri Uçlu Opak Seri**  
 Long Nose Pliers (Bent)

  
 TS 60 - TS ISO 5745

 Özel alaşımlı çelik, Kesici ağızlar indüksiyonda sertleştirilmiş  
 Special steel, Cutters induction hardened

KOD CODE	L mm	L inch	g	□	TL/Ad.
3225 13 2160	160	6 1/4"	130	5	878,50
3225 13 2180	180	7 1/8"	165	5	992,00
3225 13 2200	200	8"	175	5	1.059,25

3225

**Kargaburun Eğri Uçlu Kraft Seri**  
 Long Nose Pliers (Bent)

  
 TS 60 - TS ISO 5745

 Özel alaşımlı çelik, Kesici ağızlar indüksiyonda sertleştirilmiş  
 Special steel, Cutters induction hardened

KOD CODE	L mm	L inch	g	□	TL/Ad.
3225 13 3160	160	6 1/4"	145	5	1.056,25
3225 13 3180	180	7 1/8"	175	5	1.159,00
3225 13 3200	200	8"	185	5	1.275,25

3020 00 2003

**Opak Pense Seti 160mm (3 Parça)**  
 Opak Pliers Set 160mm (3 Pcs)

KOD CODE	L mm	İÇERİK CONTENTS	□	TL/Ad.
3020 12 2160	160	Kombine Pense Opak Seri Combination Pliers 160mm	1	2.515,00
3220 13 2160	160	Kargaburun Düz Uçlu Opak Seri Long Nose Pliers (Flat) 160mm	1	
3700 16 2160	160	Yan Keski Opak Seri Side Cutting Pliers 160mm	1	

3020 00 1002

**Pense Kontrol Kalem Seti (2 Parça)**  
 Opak Pliers Set, Voltage Tester (Flat) 2 Pcs

KOD CODE	L mm	İÇERİK CONTENTS	□	TL/Ad.
3020 12 2160	160	Kombine Pense Opak Seri Combination Pliers 160mm	1	948,25
4550 17 0190	190	Elektrik Kontrol Kalem (Düz Uçlu) Voltage Tester (Flat) 190mm	1	

**3700****Yan Keski Opak Seri**  
Side Cutting PliersTS 60 - TS ISO 5749  
DIN ISO 5749

IZELTAS YOUTUBE

**Özel alaşımli çelik, Kesici ağızlar indüksiyonda sertleştirilmiş**  
Special steel, Cutters induction hardened

KOD CODE	L mm	L inch	g	□	TL/Ad.
3700 16 2140	140	5 1/2"	155	5	777,25
3700 16 2160	160	6 1/4"	200	5	936,00
3700 16 2180	180	7 1/8"	230	5	1.090,50

**3700****Yan Keski Kraft Seri**  
Side Cutting PliersTS 60 - TS ISO 5749  
DIN ISO 5749**Özel alaşımli çelik, Kesici ağızlar indüksiyonda sertleştirilmiş**  
Special steel, Cutters induction hardened

KOD CODE	L mm	L inch	g	□	TL/Ad.
3700 16 3140	140	5 1/2"	175	5	937,25
3700 16 3160	160	6 1/4"	220	5	1.124,75
3700 16 3180	180	7 1/8"	255	5	1.310,75

**3700****1000V İzoleli Elektrikçi Yan Keski**  
Insulated Electrician Type Side Cutter 1000VTS 60  
TS ISO 5749  
DIN ISO 5749  
△ 1000 V  
IEC 60900**Özel alaşımli çelik, Kesici ağızlar indüksiyonda sertleştirilmiş, Krom kaplı**  
Special steel, Cutters induction hardened, Chrom plated

KOD CODE	L mm	L inch	g	□	TL/Ad.
3700 16 6140	140	5 1/2"	150	5	1.178,00
3700 16 6160	160	6 1/4"	205	5	1.336,75
3700 16 6180	180	7 1/8"	240	5	1.495,50

**13000 005119****Yan Keski Black Line**  
Side Cutting PliersTS 60 - TS ISO 5749  
DIN ISO 5749**Özel alaşımli çelik, Mangan fosfat kaplı, Kesici ağızlar indüksiyonda sertleştirilmiş**  
Special steel, Phosphate finish, Cutters induction hardened

KOD CODE	L mm	L inch	g	□	TL/Ad.
13000 005119	160	6 1/4"	215	5	1.505,00

13000 005133

**Black Line Set (5 Parça)**

Black Line Set (5 Pcs)



KOD CODE	İÇERİK CONTENTS	☐	TL/Ad.
13000 005118	Kombine Pense 180 mm Combination Pliers	1	4.833,00
13000 005117	Kargaburun Düz Uçlu 180 mm Long Nose Pliers (Flat)	1	
13000 005119	Yan Keski 160 mm Side Cutting Pliers	1	
13000 005116	Düz Uçlu Tornavida 6x100 Screwdriver Flat	1	
13000 005120	Yıldız Uçlu Tornavida 6x100 Screwdriver Phillips	1	

13000 005651

**Kraft Pense Seti (3 Parça)**

Craft Pliers Set (3 Pcs)



13000 005655

**Pro Set (5 Parça)**

Pro Set (5 Pcs)



KOD CODE	İÇERİK CONTENTS	☐	TL/Ad.
3020 12 3160	Kombine Pense Kraft Seri Combination Pliers 160mm	1	2.220,00
3700 16 3160	Yan Keski Kraft Seri Side Cutting Pliers 160mm	1	
14000 005049	Pro Metal Gövde Maket Bıçağı Pro Metal-Bodied Utility Knife 18mm	1	

KOD CODE	İÇERİK CONTENTS	☐	TL/Ad.
3020 12 3160	Kombine Pense Kraft Seri Combination Pliers 160mm	1	2.424,75
4550 17 0190	Elektrik Kontrol Kalem (Düz Uçlu) Voltage Tester (Flat) 190mm	1	
4240 17 0680	Değişken Uçlu Tornavida Screwdriver - Reversible (6x80)	1	
14000 005049	Pro Metal Gövde Maket Bıçağı Pro Metal-Bodied Utility Knife 18mm	1	
05881 50 005	Plastik Şerit Metre Plastic Steel Case, Measuring Tape 5m	1	

**3705 16 5160****İnce Uçlu Yan Keski (Plastikler İçin)**  
Side Cutter For PlasticsTS 60  
TS ISO 5749**3730****Yan Keski Ağır Tip (Çelik Tel İçin)**  
Side Cutter Heavy Duty (for piano wire)Özel alaşımlı çelik, Kesici ağızlar indüksiyonda sertleştirilmiş, PVC izoleli  
Special steel, Cutters induction hardened, PVC insulatedÖzel alaşımlı çelik, Kesici ağızlar indüksiyonda sertleştirilmiş  
Special steel, Cutters induction hardened

KOD CODE	L mm	L inch	g	TL/Ad.
3705 16 5160	160	6 1/4"	155	5 1.216,50

KOD CODE	L mm	L inch	g	TL/Ad.
3730 16 2160	160	6 1/4"	200	5 1.326,00
3730 16 2200	200	8"	320	5 1.722,75

**3335 00 1004****Segman Pense Takımı (4 Parça)**  
Circlip Pliers Set (4 Pcs)**YENİ TASARIM**  
NEW DESIGN

İZELTAS YOUTUBE

KOD CODE	L mm	İÇERİK CONTENTS	TL/Ad.
3301 12 0180	178	Dış Segman Pense (Düz) Circlip Pliers, External (Flat)	1
3311 12 0170	165	Dış Segman Pense (Eğri) Circlip Pliers, External (Bent)	1
3321 12 0180	180	İç Segman Pense (Düz) Circlip Pliers, Internal (Flat)	1
3331 12 0170	170	İç Segman Pense (Eğri) Circlip Pliers, Internal (Bent)	1

330112 0180  
Dış Segman Pense (Düz) ●19-603311 12 0170  
Dış Segman Pense (Eğri) ●19-60332112 0180  
İç Segman Pense (Düz) ●19-603331 12 0170  
İç Segman Pense (Eğri) ●19-60

**3301**
**Dış Segman Pense (Düz)**  
 Circlip Pliers, External (Flat)

 TS 60  
 DIN 5254

 YENİ TASARIM  
 NEW DESIGN

 Krom vanadyum, Krom kaplı, PVC izoleli  
 Chrom vanadium, Chrom plated, PVC insulated

KOD CODE	L mm	Ø	g	□	TL/Ad.
3301 12 0140	138	10 - 25	105	5	877,00
3301 12 0180	178	19 - 60	170	5	925,00
3301 12 0225	220	40 - 100	245	5	1.156,00
3301 12 0295	305	85 - 140	480	5	1.959,25

**3321**
**İç Segman Pense (Düz)**  
 Circlip Pliers Internal (Flat)

 TS 60  
 DIN 5256

 YENİ TASARIM  
 NEW DESIGN

 Krom vanadyum, Krom kaplı, PVC izoleli  
 Chrom vanadium, Chrom plated, PVC insulated

KOD CODE	L mm	Ø	g	□	TL/Ad.
3321 12 0140	143	12 - 25	105	5	808,75
3321 12 0180	180	19 - 60	180	5	852,50
3321 12 0225	228	40 - 100	260	5	1.060,25
3321 12 0310	305	85 - 140	545	5	1.819,50

**3311**
**Dış Segman Pense (Eğri)**  
 Circlip Pliers, External (Bent)

 TS 60  
 DIN 5254

 YENİ TASARIM  
 NEW DESIGN

 Krom vanadyum, Krom kaplı, PVC izoleli  
 Chrom vanadium, Chrom plated, PVC insulated

KOD CODE	L mm	Ø	g	□	TL/Ad.
3311 12 0125	130	10 - 25	105	5	981,00
3311 12 0170	165	19 - 60	190	5	1.031,75
3311 12 0210	207	40 - 100	250	5	1.186,25
3311 12 0275	290	85 - 140	420	5	2.056,50

**3331**
**İç Segman Pense (Eğri)**  
 Circlip Pliers Internal (Bent)

 TS 60  
 DIN 5256

 YENİ TASARIM  
 NEW DESIGN

 Krom vanadyum, Krom kaplı, PVC izoleli  
 Chrom vanadium, Chrom plated, PVC insulated

KOD CODE	L mm	Ø	g	□	TL/Ad.
3331 12 0130	133	12 - 25	105	5	868,75
3331 12 0170	170	19 - 60	175	5	914,00
3331 12 0210	212	40 - 100	260	5	1.141,25
3331 12 0290	385	85 - 140	460	5	1.956,25



**3420 12 0220****Hortum Kelepçe Pensesi**  
Hose Clamp Pliers

KOD CODE	L mm	L inch	g		TL/Ad.
3420 12 0220	220	8 3/4"	260	5	1.558,50

**3425 12 0220****Hortum Kelepçe Pensesi (Sıkıştırma Tipi)**  
Hose Clamp Pliers

KOD CODE	L mm	L inch	g		TL/Ad.
3425 12 0220	235	9 1/4"	345	5	1.596,75

**3852 24 0225****Delik Zimba**  
Revolving Punch PliersÖlçü / Size  $\emptyset 2 - \emptyset 2.5 - \emptyset 3 - \emptyset 3.5 - \emptyset 4 - \emptyset 4.5$ 

KOD CODE	L mm	L inch	g		TL/Ad.
3852 24 0225	225	9"	280	5	1.092,00

**3720 16 0220****Çift Ağızlı Kablo Kesici**  
Cable Cutter, Double Cutter**YENİ TASARIM**  
NEW DESIGNÖzel alaşımlı çelik, Kesici ağızlar indüksiyonda sertleştirilmiş, PVC izoleli  
Special steel, Cutters induction hardened, PVC insulated

KOD CODE	L mm	L inch	g		TL/Ad.
3720 16 0220	200	8"	255	5	1.343,50

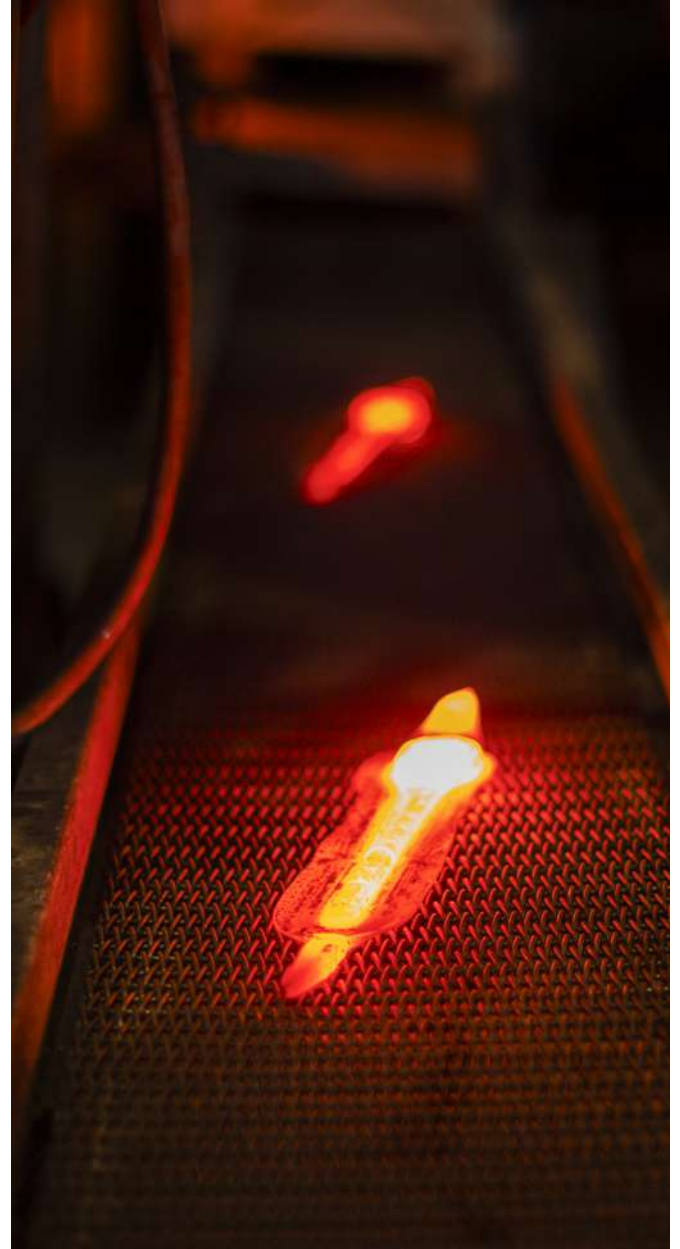

**3715 16 0165**
**Tek Ağızlı Kablo Kesici**  
 Cable Cutter

 Özel alaşımlı çelik, Kesici ağızlar indüksiyonda sertleştirilmiş, PVC izoleli  
 Special steel, Cutters induction hardened, PVC insulated

KOD CODE	L mm	L inch	g		TL/Ad.
3715 16 0165	165	6 1/4	205	5	1.047,00

**3715 16 6165**
**1000V İzoleli Tek Ağızlı Kablo Kesici**  
 Cable Cutter 1000V

 ⚡ 1000 V  
 IEC 60900

 Özel alaşımlı çelik, Kesici ağızlar indüksiyonda sertleştirilmiş  
 Special steel, Cutters induction hardened

KOD CODE	L mm	L inch	g		TL/Ad.
3715 16 6165	165	6 1/4	225	5	1.232,75



**3550 14 0125**

**Elektronikçi Yan Keski**

Electronic Diagonal Side Cutting Pliers



Özel alaşımli çelik  
Special steel

KOD CODE	L mm	g	TL/Ad.
3550 14 0125	125	75	5 1.064,50

**3553 14 0150**

**Elektronikçi Düz Uçlu Kargaburun**

Electronic Flat Long Nose Pliers



Özel alaşımli çelik  
Special steel

KOD CODE	L mm	g	TL/Ad.
3553 14 0150	150	85	5 960,50

**3551 14 0125**

**Elektronikçi Tepe Keski**

Electronic End Cutting Pliers



Özel alaşımli çelik  
Special steel

KOD CODE	L mm	g	TL/Ad.
3551 14 0125	125	75	5 993,25

**3554 14 0150**

**Elektronikçi Uzun Kargaburun**

Electronic Long Nose Pliers



Özel alaşımli çelik  
Special steel

KOD CODE	L mm	g	TL/Ad.
3554 14 0150	150	90	5 960,50

**3552 14 0125**

**Elektronikçi Yuvarlak Uçlu Kargaburun**

Electronic Round Nose Pliers



Özel alaşımli çelik  
Special steel

KOD CODE	L mm	g	TL/Ad.
3552 14 0125	125	80	5 964,50

**3555 14 0150**

**Elektronikçi Sivri Uçlu Düz Kargaburun**

Electronic Needle Flat Long Nose Pliers



Özel alaşımli çelik  
Special steel

KOD CODE	L mm	g	TL/Ad.
3555 14 0150	150	85	5 960,50

**3556 14 0150**
**Elektronikçi Sivri Uçlu Eğri Kargaburun**  
 Electronic Needle Bent Long Nose Pliers

 Özel alaşımlı çelik  
 Special steel

KOD CODE	L mm	g	□	TL/Ad.
3556 14 0150	150	85	5	960,50

**3557 14 0125**
**Elektronikçi Pense**  
 Electronic Pliers

 Özel alaşımlı çelik  
 Special steel

KOD CODE	L mm	g	□	TL/Ad.
3557 14 0125	125	80	5	964,50

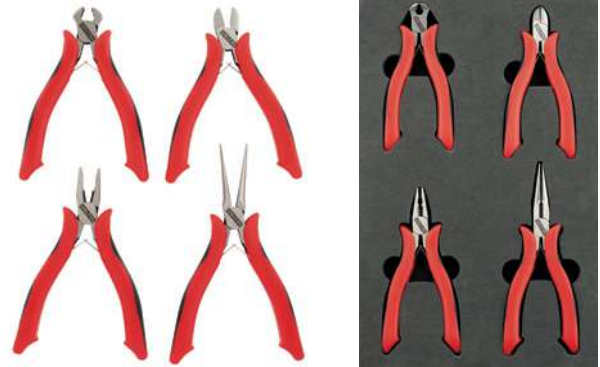
**3560 00 2104**
**Elektronikçi Keski ve Pense Seti (4 Parça)**  
 Electronic Cutter & Pliers Set (4 Pcs)

KOD CODE	L mm	İÇERİK CONTENTS	□	TL/Ad.
3550 14 0125	125	Elektronikçi Yan Keski Electronic Diagonal Side Cutting Pliers	1	3.982,75
3551 14 0125	125	Elektronikçi Tepe Keski Electronic End Cutting Pliers	1	
3554 14 0150	150	Elektronikçi Uzun kargaburun Electronic Long Nose Pliers	1	
3557 14 0125	125	Elektronikçi Pense Electronic Pliers	1	

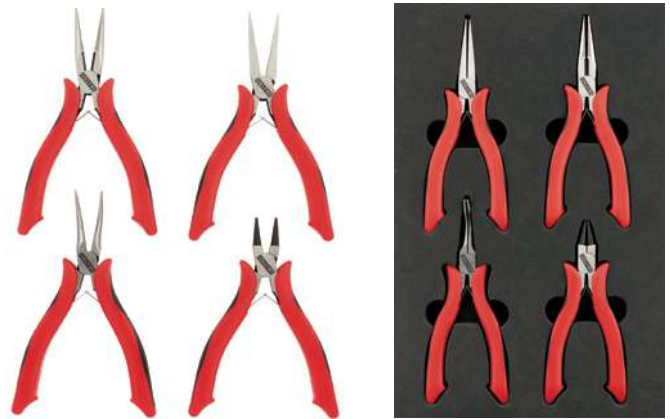
**3565 00 2104**
**Elektronikçi Kargaburun Seti (4 Parça)**  
 Electronic Long Nose Pliers Set (4 Pcs)

KOD CODE	L mm	İÇERİK CONTENTS	□	TL/Ad.
3552 14 0125	125	Elektronikçi Yuvarlak Uçlu Kargaburun Electronic Round Long Nose Pliers	1	3.846,00
3553 14 0150	150	Elektronikçi Düz Uçlu Kargaburun Electronic Flat Long Nose Pliers	1	
3555 14 0150	150	Elektronikçi Sivri Uçlu Düz Kargaburun Electronic Long Nose Pliers	1	
3556 14 0150	150	Elektronikçi Sivri Uçlu Eğri Kargaburun Electronic Bent Long Nose Pliers	1	

**3800****Kerpeten**  
Carpenter PincersTS 60 - TS ISO 9243  
DIN ISO 9243

Özel alaşımli çelik, Kesici ağızlar indüksiyonda sertleştirilmiş,  
Mangan Fosfat Kaplı, PVC izoleli  
Special steel, Cutters induction hardened, Black finish, PVC insulated

KOD CODE	L mm	L inch	g	TL/Ad.
3800 15 0160	160	6 1/4"	210	934,75
3800 15 0180	180	7 1/8"	205	968,25
3800 15 0200	200	8"	355	1.151,50
3800 15 0250	250	10"	510	1.205,50

**3830****Betoncu Kerpeteni**  
Tower PincersTS 60 - TS ISO 9242  
DIN ISO 9242

Özel alaşımli çelik, Kesici ağızlar indüksiyonda sertleştirilmiş,  
Mangan Fosfat Kaplı, PVC izoleli  
Special steel, Cutters induction hardened, Black finish, PVC insulated

KOD CODE	L mm	L inch	g	TL/Ad.
3830 15 0225	225	9"	345	953,75
3830 15 0250	250	10"	395	1.053,50
3830 15 0280	280	11"	440	1.257,50

**3831 15 0280****Betoncu Kerpeteni Yaylı**  
Tower Pincers with springTS 60 - TS ISO 9242  
DIN ISO 9242

Özel alaşımli çelik, Kesici ağızlar indüksiyonda sertleştirilmiş,  
Mangan Fosfat Kaplı, PVC izoleli  
Special steel, Cutters induction hardened, Black finish, PVC insulated

KOD CODE	L mm	L inch	g	TL/Ad.
3831 15 0280	280	11"	450	1.261,50

**3835 15 0280****Ağır Tip Betoncu Kerpeteni**  
Heavy Duty Tower PincersTS 60 - TS ISO 9242  
DIN ISO 9242

İZELTAS YOUTUBE

Özel alaşımli çelik, Kesici ağızlar indüksiyonda sertleştirilmiş,  
Mangan Fosfat Kaplı, PVC izoleli  
Special steel, Cutters induction hardened, Black finish, PVC insulated

KOD CODE	L mm	L inch	g	TL/Ad.
3835 15 0280	280	11"	440	1.250,75

**3850 12 0200****Danallya**  
Shoemaker Pliers

Özel alaşımli çelik, İndüksiyonda sertleştirilmiş  
Special steel, Induction hardened

KOD CODE	L mm	L inch	g	TL/Ad.
3850 12 0200	200	8"	345	1.552,75

**IZELTAS®**

# 1000V İZOLELİ ALETLER

1000V INSULATED TOOLS



İZELTAS YOUTUBE



1000V Grubu Ürünler / 1000V Product Group



- » El aletleri sektörünün lider markası İZELTAŞ'ın VDE belgeli ürünleri elektrik sektöründe fark yaratıyor.
- Bu ürünler elektrik sektöründe 1000V izolasyon sağlamak için özel olarak tasarlanmış yanmaz sapları ile kullanıcıya güven verir.
  - Elektrik akımının bulunduğu alanlarda güvenli kullanım sağlar.
  - Yanma, 1000V elektrik direnci, soğuk ve sıcak havalarda sap sökme deneyleri başta olmak üzere pek çok özel testten geçirilen ürünler, Alman VDE firmasından onaylıdır.
  - Ergonomik sap tasarımı ile tutuş ve kullanım kolaylığı sağlar.



- » As the leading brand in hand tools sector, VDE certified products of İZELTAŞ make a difference in electrical sector.
- These products assure the user with their handles specially designed to provide isolation up to 1000 V.
  - They provide safe use in areas with electrical current.
  - The products are certified by German VDE institution, being subjected to various tests particularly including fire resistance, 1000 V electrical resistance and handle detachment tests in hot and cold air conditions.
  - They provide ease of grip and use with an ergonomic design.



### Çalışma sırasında nelere dikkat edilmelidir?

- Elektrik akımının var olduğu alanlarda yalnızca özel eğitilmiş ve alanında uzman kişiler çalışmalıdır.
- Her kullanım öncesinde VDE belgeli ürünlerde ve izolelerinde hasar olup olmadığı kontrol edilmelidir.
- VDE belgeli ürünler amacı dışında ya da birleştirilerek kullanılmamalıdır.
- VDE belgeli ürünler ile koruyucu ekipmanlarınızı da güvenlik amacıyla kullanmalısınız.



### Important points for use

- Only specially trained and expert personnel should engage in work in areas with electrical current.
- Before each use VDE certified products and their isolation materials should be checked against damage.
- VDE certified products should not be used outside their purpose or in combination.
- Protective equipment should also be used to protect personnel in addition to VDE certified products.



**VDE belgeli ürünlerimiz, ilgili uluslararası standartlara göre kontrol edildikten sonra ek olarak beş ayrı teste tabi tutulur**

- » 1- Voltaj Testi: 3 dakika boyunca 10.000V'a tabi tutulan izoleli el aletinde kaçak yada elektrik akımı atlaması olmamalıdır.
- 2- Soğuk Şoklama Testi : -24 derece 2 saat bekletilmiş (şoklanmış) el aletine 60-80 cm yükseklikten 600gr ağırlık ile darbeler uygulanır. İzolede kırılma ya da çatlama olmamalıdır.
- 3- Dayanıklılık Testi: +70 derece 1 hafta bekletilmiş el aletine 50kg yük ile sap sökme testi uygulanır. Sap yerinden gıkmamalıdır.
- 4- Geçirgenlik Testi: 5000V elektrik akımına karşı 3 dakika boyunca 2kg sivri uçlu ağırlıkta baskı yapılarak elektrik verilir. Kaçak ya da elektrik atlaması olmamalıdır.
- 5- Yanma Testi: Yüksek yoğunluktaki alev 20 saniye maruz bırakılarak teste tabi tutulur. Alevden uzaklaştırılan izole yanmaya devam etmemelidir.

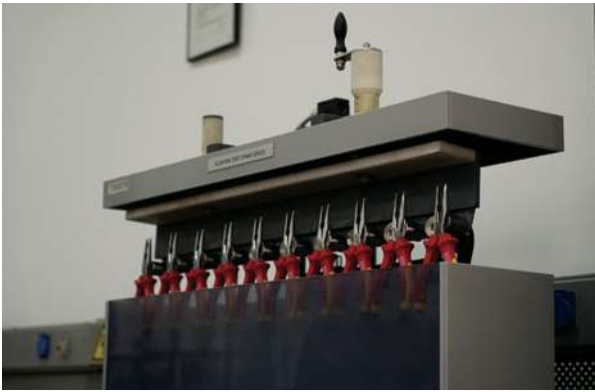

**Our VDE certified products are controlled in accord with the applicable international standards and then are subjected to five different tests:**

- » 1- Voltage Test: No residual current or electrical arc should be seen on the isolated hand tool subjected to 10,000 V for 3 minutes.
- 2- Cold Shock Test: Hand tools left in -24 °C for 2 hours (shocked) are subjected to impacts with a 600 gr weight dropped from a height of 60-80 cm. No breakage or cracking should be seen on the isolation material.
- 3- Durability Test: Hand tools left in +70 °C for 1 week are subjected to handle detachment test with a load of 50 kg. The handle should not detach.
- 4- Perviousness Test: Pointed tips under 2 kg load are used to apply 5000 V electrical current for 3 minutes. There should be to residual current or electrical arc.
- 5- Fire Test: The tool is subjected to high intensity flames for 20 seconds. After contact with the flame is ended the isolation material should not continue burning.



**Güçlü kavrama sağlayan  
tırnaklı tutma yüzeyleri**  
Toothed surface for strong grip

**Isıl işlem sonrasında indüksiyonda  
sertleştirme ile kullanım  
ömrü artırılmış kesici ağızlar**  
Heat-treated and induction hardened cutting  
edges for long lifetime

**Nikel üzerine krom kaplama ile  
korozyon direncinde  
üst seviye koruma**  
High corrosion resistance  
with chrome over nickel plating

**Yüksek karbonlu  
sıcak dövme çeliği  
ile artırılmış  
dayanım**  
High carbon forged steel  
for improved durability

**VDE/GS belgeli, 1000V dayanımlı,  
sert plastikten ve konforlu tutuş  
sağlayan yumuşak elastomer  
malzemeden imal edilmiş  
dayanımı yüksek çift  
komponentli ergonomik sap**  
VDE/GS certified, insulated for 1000V  
usage. Two component ergonomic  
handle with high strength and  
soft grip plastic



0255

**Süper İzole Çatal Bir Ağız Anahtar (mm)**  
Single Ended Open Jaw Wrench  
Super Insulated (mm)

⚡ 1000 V  
IEC 60900



Krom vanadyum, Krom kaplı, Kalın PVC izoleli  
Chrom vanadium, Chrom plated, Triple PVC insulated

KOD CODE	mm	L mm	g	TL/Ad.
0255 01 0010	10	110	40	373,00
0255 01 0011	11	120	50	394,25
0255 01 0012	12	130	65	413,00
0255 01 0013	13	140	0	444,25
0255 01 0014	14	155	95	460,00
0255 01 0017	17	170	135	564,25
0255 01 0019	19	185	170	661,50
0255 01 0022	22	200	240	890,00
0255 01 0024	24	220	310	1.088,50

0435

**Süper İzoleli Yıldız Bir Ağız Anahtar (mm)**  
Single Ended Ring Wrench  
Super Insulated (mm)

⚡ 1000 V  
IEC 60900



Krom vanadyum, Krom kaplı, Kalın PVC izoleli  
Chrom vanadium, Chrom plated, Triple PVC insulated

KOD CODE	mm	L mm	g	TL/Ad.
0435 03 0010	10	170	80	497,25
0435 03 0011	11	175	85	497,25
0435 03 0012	12	180	115	564,25
0435 03 0013	13	185	120	564,25
0435 03 0014	14	190	135	592,75
0435 03 0017	17	205	180	671,25
0435 03 0019	19	220	215	799,75
0435 03 0022	22	245	310	877,25
0435 03 0024	24	270	380	1.171,00

0600 01 0010

**1000V İzoleli Kurbağacık Anahtar**  
Insulated Electrician Type Adjustable  
Wrench 1000V

TS ISO 6787  
⚡ 1000 V  
IEC 60900



Krom vanadyum, Krom kaplı, Kalın PVC izoleli  
Chrom vanadium, Chrom plated, Triple PVC insulated

KOD CODE	L mm	L inch	mm	g	TL/Ad.
0600 01 0010	260	10"	28	475	5 1.798,00

**1000V 1/2" Altı Köşe Lokma Anahtar (mm)**  
Socket Wrench 6 Points 1000V (mm)

TS ISO 2725-1  
DIN 3124  
⚡ 1000 V  
IEC 60900



1/2"

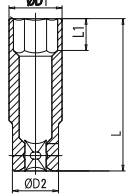

Krom vanadyum, Krom kaplı  
Chrom vanadium, Chrom plated

KOD CODE	mm	σ D1 mm	σ D2 mm	L mm	L1 mm	g	TL/Ad.
13000 005148	10	19,5	27	40	7	55	1 751,50
13000 005149	11	20.7	27	40	7	60	1 747,00
13000 005150	12	22	27	40	8	60	1 760,75
13000 005151	13	23.2	27	40	8	60	1 763,75
13000 005152	14	24.5	27	40	9	60	1 769,00
13000 005153	15	25.7	27	40	10	65	1 773,00
13000 005154	16	27	27	40	11	70	1 788,25
13000 005155	17	28.2	27	40	11	70	1 799,25
13000 005156	19	30.7	27	42	11	80	1 815,50
13000 005157	22	34.5	27	44	12	105	1 836,00
13000 005158	24	37	27	46	13	125	1 852,50
13000 005159	27	40.7	27	48	13	170	1 1.005,50

13000 005277

**1000V 1/2" Cırcır Kolu (36 Diş)**  
Ratchet Handle 1000V (36 Teeth)

⚡ 1000 V  
IEC 60900



1/2"



KOD CODE	L mm	g	TL/Ad.
13000 005277	275	625	1 7.246,50

**IZELTAS®**

1000V Grubu Ürünler / 1000V Product Group

**1000V 1/2" Ara Kol**  
Extension Bar 1000V⚡ 1000 V  
IEC 60900**1/2"****Krom vanadyum, Krom kaplı**  
Chrom vanadium, Chrom plated

KOD CODE	L mm	g		TL/Ad.
13000 005262	75	235	1	1.921,00
13000 005263	125	470	1	2.130,25
13000 005264	250	465	1	2.892,25

**13000 005541****1000V 1/2" T Kol**  
1000V Sliding T - Handle⚡ 1000 V  
IEC 60900**1/2"****Krom vanadyum, Krom kaplı**  
Chrom vanadium, Chrom plated

KOD CODE	L mm	g		TL/Ad.
13000 005541	200	695	5	1.766,25

**2400 11 6240****1000V İzoleli Ünsel Fort Pense**  
Insulated Type Waterpump  
Pliers Universal 1000VTS 60  
TS ISO 8976  
⚡ 1000 V  
IEC 60900**Krom vanadyum, Krom kaplı, çift komponent saplı**  
Chrom vanadium, Chrom plated, Two component handle

KOD CODE	L mm	L inch	mm	g		TL/Ad.
2400 11 6240	240	9 1/2"	35	375	5	1.393,00

**3715 16 6165****1000V İzoleli Tek Ağızlı Kablo Kesici**  
Cable Cutter 1000V⚡ 1000 V  
IEC 60900**Özel alaşımli çelik, Kesici ağızlar indüksiyonda sertleştirilmiş**  
Special steel, Cutters induction hardened

KOD CODE	L mm	L inch	g		TL/Ad.
3715 16 6165	165	6 1/4	225	5	1.232,75

**03753 50 026****Elektro Mekanik Kablo Sıyırıcı**  
Mechanical Cable Stripper

KOD CODE	ÖLÇÜ SIZE	g		TL/Ad.
03753 50 026	0.2 / 6	110	5	1.974,25

**3020**
**1000V İzoleli Elektrikçi Kombine Pense**  
 Insulated Electrician Type Combination Pliers 1000V

 TS 60  
 TS ISO 5746  
 DIN ISO 5746  
 ⚡ 1000 V  
 IEC 60900

 Özel alaşımlı çelik, Kesici ağızlar indüksiyonda sertleştirilmiş, Krom kaplı  
 Special steel, Cutters induction hardened, Chrom plated

KOD CODE	L mm	L inch	g	□	TL/Ad.
3020 12 6160	160	6 1/4"	210	5	1.026,00
3020 12 6180	180	7 1/8"	260	5	1.100,25
3020 12 6200	200	8"	350	5	1.241,00

**3700**
**1000V İzoleli Elektrikçi Yan Keski**  
 Insulated Electrician Type Side Cutter 1000V

 TS 60  
 TS ISO 5749  
 DIN ISO 5749  
 ⚡ 1000 V  
 IEC 60900

 Özel alaşımlı çelik, Kesici ağızlar indüksiyonda sertleştirilmiş, Krom kaplı  
 Special steel, Cutters induction hardened, Chrom plated

KOD CODE	L mm	L inch	g	□	TL/Ad.
3700 16 6140	140	5 1/2"	150	5	1.178,00
3700 16 6160	160	6 1/4"	205	5	1.336,75
3700 16 6180	180	7 1/8"	240	5	1.495,50

**3220**
**1000V İzoleli Elektrikçi Kargaburun Düz Uçlu**  
 Insulated Electrician Type Long Nose Pliers 1000V

 TS 60  
 TS ISO 5745  
 DIN ISO 5745  
 ⚡ 1000 V  
 IEC 60900

 Özel alaşımlı çelik, Kesici ağızlar indüksiyonda sertleştirilmiş, Krom kaplı  
 Special steel, Cutters induction hardened, Chrom plated

KOD CODE	L mm	L inch	g	□	TL/Ad.
3220 13 6140	140	5 1/2"	100	5	1.051,00
3220 13 6160	160	6 1/4"	130	5	1.161,75
3220 13 6180	180	7 1/8"	160	5	1.304,00
3220 13 6200	200	8"	170	5	1.354,50

**3020 00 6003**
**1000V İzoleli Elektrikçi Seti (3 Parça)**  
 1000V Insulated Tool Set (3 Pcs)

KOD CODE	İÇERİK CONTENTS	□	TL/Ad.
3020 12 6160	160 mm 1000V İzoleli Elektrikçi Kombine Pense Insulated Electrician Type Combination Pliers	1	3.524,50
3220 13 6160	160 mm 1000V İzoleli Elektrikçi Kargaburun Düz Uçlu Insulated Electrician Type Long Nose Pliers	1	
3700 16 6160	160 mm 1000V İzoleli Elektrikçi Yankeski Insulated Electrician Type Side Cutter	1	

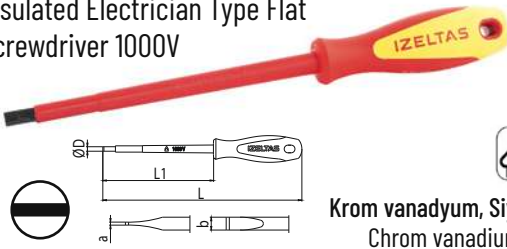

4140

**1000V İzoleli Elektrikçi Düz Uçlu Tornavida**  
Insulated Electrician Type Flat  
Screwdriver 1000VTS ISO 2380-1  
DIN ISO 2380-1  
⚡ 1000 V  
IEC 60900Krom vanadyum, Siyah oksit kaplı  
Chrom vanadium, Black finish

KOD CODE	øDxL1 mm	⊖		L mm	g	□	TL/Ad.
		a mm	b mm				
4140 17 2575	2.5x75	0.4	2.5	150	30	10	170,00
4140 17 4100	4x100	0.8	4	185	45	10	198,50
4140 17 5512	5.5x125	1	5.5	220	75	10	261,50
4140 17 6515	6.5x150	1.2	6.5	245	90	10	291,75

4145

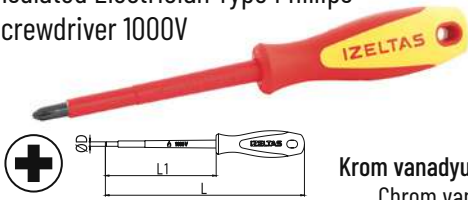
**1000V İzoleli Elektrikçi Yıldız Uçlu Tornavida**  
Insulated Electrician Type Phillips  
Screwdriver 1000VTS 59-5 ISO 8764  
DIN ISO 8764  
⚡ 1000 V  
IEC 60900Krom vanadyum, Siyah oksit kaplı  
Chrom vanadium, Black finish

KOD CODE	øDxL1 mm	+	L mm	g	□	TL/Ad.
4145 18 0360	3x60	Ph0	135	20	10	176,75
4145 18 4580	4.5x80	Ph1	165	50	10	249,25
4145 18 6100	6x100	Ph2	195	80	10	291,75

4140 00 9106

**1000V İzoleli Elektrikçi Tornavida Seti (6 Parça)**  
Insulated Electrician Screwdriver Set 1000V (6 Pcs)

KOD CODE	İÇERİK CONTENTS	g	□	TL/Ad.
4140 00 9106	⊖ 2.5x75 - 4x100	380	6	1.462,75
	⊖ 5.5x125 - 6.5x150			
	⊖ Düz uçlu / Flat			
	⊕ 4.5x80 - 6x100			
	⊕ Yıldız uçlu / Phillips			

4773

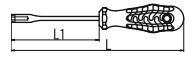
**1000V Süngüsü İzoleli Lokma Uçlu Tornavida**  
Nut Spinner, Electrician Blade Insulated 1000V⚡ 1000 V  
IEC 60900Krom vanadyum, iki component saplı  
Chrom vanadium, Two component handle

KOD CODE	⊖ mm	L mm	L1 mm	g	□	TL/ Ad.
4773 19 0040	4	220	125	75	10	548,75
4773 19 0050	5	220	125	75	10	548,75
4773 19 0055	5.5	220	125	80	10	548,75
4773 19 0060	6	220	125	90	10	548,75
4773 19 0070	7	230	125	120	10	588,25
4773 19 0080	8	230	125	120	10	588,25
4773 19 0090	9	230	125	125	10	635,00
4773 19 0100	10	230	125	125	10	635,00
4773 19 0110	11	230	125	140	10	692,50
4773 19 0120	12	230	125	140	10	743,00
4773 19 0130	13	230	125	150	10	800,50
4773 19 0140	14	230	125	160	10	885,25

4773 00 8108

**1000V Süngüsü İzoleli Lokma Uçlu Tornavida Takımı (8 Parça)**  
Nut Spinner, Electrician Blade Insulated Set 1000V (8 Pcs)

KOD CODE	İÇERİK CONTENTS	g	□	TL/Ad.
4773 00 8108	6 - 7 - 8 - 9 - 10 - 11 - 12 - 13	2225	8	5.231,25

4783 19 6120

**1000V Süngüsü İzoleli Manyetik Bits Tutucu Tornavida**  
Screwdriver, Magnetic Bit Holder Insulated 1000V

⚡ 1000 V  
IEC 60900

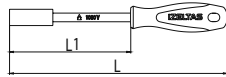

Krom vanadyum, iki komponent saplı  
Chrom vanadium, Two component handle

KOD CODE	mm	L mm	L1 mm	g	TL/Ad.
4783 19 6120	6.3	230	120	120	10 / 617,25

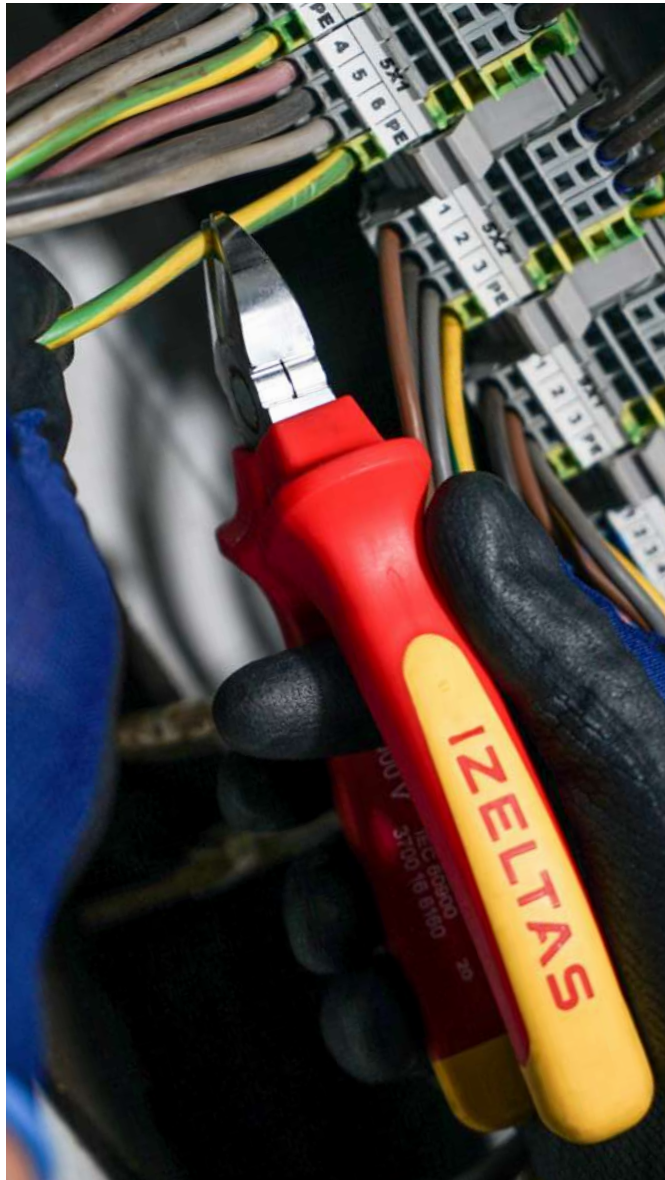

**1000V İzoleli T Tipi Allen Anahtar (mm)**  
Hex Key Wrench T - Handle Insulated 1000V

**YENİ TASARIM**  
NEW DESIGN

⚡ 1000 V  
IEC 60900

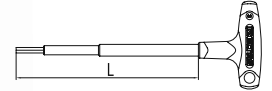

Krom vanadyum, iki komponent saplı  
Chrom vanadium, Two component handle

KOD CODE	mm	L mm	g	TL/Ad.
13000 005610	2.5	88	15	5 / 249,25
13000 005611	3	102	20	5 / 253,25
13000 005612	4	110	35	5 / 284,75
13000 005613	5	125	55	5 / 304,00
13000 005614	6	140	80	5 / 346,50
13000 005615	7	150	105	5 / 364,00
13000 005616	8	154	145	5 / 427,00
13000 005617	10	180	225	5 / 663,50

13000 008092

**1000V İzoleli T Tipi Allen Anahtar Takımı (8 Parça, mm)**  
Hex Key Wrench T - Handle Set Insulated 1000V (8 Pcs, mm)

**YENİ TASARIM**  
NEW DESIGN



KOD CODE	İÇERİK CONTENTS	g	TL/Ad.
13000 008092	2.5 - 3 - 4 - 5 6 - 7 - 8 - 10	695	8 / 2.891,00



14000 005342

**1000V İzoleli Elektro Slim Tornavida Seti (14 Parça)**  
Insulated Electro Slim Screwdriver Set 1000V (14 Pcs)**ELEKTROSLIM** ⚡

KOD CODE	İÇERİK CONTENTS	g	Q	TL/Ad
14000 005342	1000V İzoleli Elektro Slim Düz Uçlu Tornavida 2.5x75 - 3x100 - 3.5x100 - 4x100 - 5.5x100 - 6.5x100 Insulated Electro Slim Type Flat Screwdriver 1000V		6	
	1000V İzoleli Elektro Slim Yıldız Uçlu Tornavida Ph1 - Ph2 Insulated Electro Slim Type Phillips Screwdriver 1000V		2	
	1000V İzoleli Elektro Slim Pozidriv Yıldız Uçlu Tornavida Pz2 Insulated Electro Slim Type Phillips Pozidriv Screwdriver 1000V	840	1	3.414,75
	1000V İzoleli Elektro Slim Torx® Uçlu Tornavida T10 - T15 - T20 Insulated Electro Slim Type Torx® Screwdriver 1000V		3	
	1000V İzoleli Elektro Slim Oto Tornavida Sap Insulated Electro Slim Screwdriver Handle 1000V		1	
	1000V İzoleli Elektro Slim tornavida Klemens Tutucu Başlık Insulated Electro Slim Screwdriver Head 1000V		1	

14000 005335

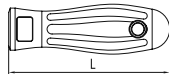
**1000V İzoleli Elektro Slim Oto Tornavida Sap**  
Insulated Electro Slim Screwdriver Handle 1000V⚡ 1000 V  
IEC 60900

KOD CODE	L mm	g	Q	TL/Ad
14000 005335	100	55	1	216,50

14000 005334

**1000V İzoleli Elektro Slim Klemens Tutucu Başlık**  
Insulated Electro Slim Screwdriver Head 1000V⚡ 1000 V  
IEC 60900

KOD CODE	g	Q	TL/Ad
14000 005334	5	10	22,00

### 1000V İzoleli Elektro Slim Düz Uçlu Tornavida Insulated Electro Slim Type Flat Screwdriver 1000V

△1000 V  
IEC 60900

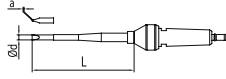

KOD CODE	Ød x L mm	a mm	g	TL/Ad
14000 005328	2.5x75	0,4	35	1 182,25
14000 005330	3x100	0,5	40	1 189,00
14000 005329	3.5x100	0,6	40	1 189,00
14000 005331	4x100	0,6	40	1 189,00
14000 005332	5.5x100	1	45	1 208,25
14000 005333	6.5x100	1,2	55	1 208,25

### 1000V İzoleli Elektro Slim Torx® Uçlu Tornavida Insulated Electro Slim Type Torx® Screwdriver 1000V

△1000 V  
IEC 60900

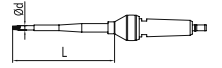

KOD CODE	Ød x L mm	T	g	TL/Ad
14000 005336	3,5x100	T10	40	1 189,00
14000 005337	3,5x100	T15	40	1 189,00
14000 005338	4,5x100	T20	40	1 189,00

### 1000V İzoleli Elektro Slim Yıldız Uçlu Tornavida Insulated Electro Slim Type Phillips Screwdriver 1000V

△1000 V  
IEC 60900

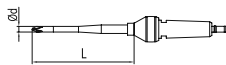

KOD CODE	Ød x L mm	Ph	g	TL/Ad
14000 005339	4,5x80	Ph1	40	1 198,50
14000 005340	6x100	Ph2	50	1 198,50

### 1000V İzoleli Elektro Slim Pozidriv Yıldız Uçlu Tornavida Insulated Electro Slim Type Phillips Pozidriv Screwdriver 1000V

△1000 V  
IEC 60900

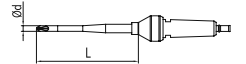

KOD CODE	Ød x L mm	Pz	g	TL/Ad
14000 005341	6x100	Pz2	50	1 198,50

**19" Plastik Takım Çantası Elektrikçi Set (23 Parça)**  
Plastic Tool Box for Electrician 19" (23 Pcs)

KOD CODE	İÇERİK CONTENTS	TL/ Ad.
8440 33 1019	19" Plastik Takım Çantası Plastic Tool Box	1
3700 16 6160	160 mm 1000V İzoleli Elektrikçi Yan Keski Insulated Electrician Type Side Cutter 1000V	1
3020 12 6180	180 mm 1000V İzoleli Elektrikçi Kombine Pense Insulated Electrician Type Combination Pliers 1000V	1
3220 13 6160	160 mm 1000V İzoleli Elektrikçi Kargaburun Düz Uçlu Insulated Electrician Type Long Nose Pliers 1000V	1
4773 19 0100	1000V Süngüsü İzoleli Lokma Uçlu Tornavida 10mm Nut Spinner, Electrician Blade Insulated 1000V	1
4773 19 0130	1000V Süngüsü İzoleli Lokma Uçlu Tornavida 13mm Nut Spinner, Electrician Blade Insulated 1000V	1
3715 16 6165	165mm 1000V İzoleli Elektrikçi Tek Ağız Kablo Kesici Cable Cutter 1000V	1
4520 18 0360	3x60 Klemens Yıldız Tornavida Electronic Screwdriver, Phillips	1
4520 18 0480	4x80 Klemens Yıldız Tornavida Electronic Screwdriver, Phillips	1
4500 17 0380	3x80 Klemens Düz Tornavida Electronic Screwdriver, Flat	1
4500 17 0480	4x80 Klemens Düz Tornavida Electronic Screwdriver, Flat	1
4140 17 4100	4x100 1000V İzoleli Elektrikçi Düz Tornavida Insulated Electrician Type Flat Screwdriver 1000V	1
4145 18 4580	4,5x80 1000V İzoleli Elektrikçi Yıldız Tornavida Insulated Electrician Type Phillips Screwdriver 1000V	1
4145 18 6100	6x100 1000V İzoleli Elektrikçi Yıldız Tornavida Insulated Electrician Type Phillips Screwdriver 1000V	1
4550 17 0190	190 mm Kontrol Kalemi Voltage Tester Flat	1
4560 18 0190	190 mm Yıldız Kontrol Kalemi Voltage Tester Phillips	1
4783 19 6120	6.3x120 1000V İzoleli Elektrikçi Manyetik Bits Tutucu Tornavida Screwdriver, Magnetic Bit Holder Insulated 1000V	1

10.120,75

13000 005538

**Elektro Takım Çantası (24 Parça)**  
**Electro Tool Bag (24 Pcs)**

KOD CODE	İÇERİK CONTENTS	☐	TL/Ad.
03752 50 625	Kablo Sıyrıcı Cable Stripper	1	24.971,00
05881 50 005	Plastik Şerit Metre Plastic Steel Case, Measuring tapes	1	
3020 12 6180	1000V İzoleli Elektrikçi Kombine Pense 180mm Insulated Electrician Type Combination Pliers 1000V	1	
3220 13 6180	1000V İzoleli Elektrikçi Kargaburun Düz Uçlu 180mm Insulated Electrician Type Long Nose Pliers 1000V	1	
3700 16 6160	1000V İzoleli Elektrikçi Yan Keski 160mm Insulated Electrician Type Side Cutter 1000V	1	
4140	1000V İzoleli Elektrikçi Düz Uçlu Tornavida 2.5x75 - 4x100 - 5.5x125 Insulated Electrician Type Flat Screwdriver 1000V	3	
4145	1000V İzoleli Elektrikçi Yıldız Uçlu Tornavida 3x60 - 4.5x80 - 6x100 Insulated Electrician Type Phillips Screwdriver 1000V	3	
4550 17 0190	Elektrik Kontrol Kalemı 190mm (Düz Uçlu) Voltage Tester (Flat)	1	
13000 005263	1000V 1/2" Altı Köşe Lokma Anahtar (mm) Socket Wrench 6 Points 1000V (mm) 10 - 11 - 12 - 13 - 14 - 15 - 16 - 17 - 19	9	
13000 005277	1000V Ara Kol 125mm Extension Bar 1000V	1	
13000 005277	1000V 1/2" Cırcır Kolu (32 Diş) Ratchet Handle 1000V (32 Teeth)	1	

8795 00 6005

**1000V İzoleli Elektrikçi Seti (5 Parça)**  
**1000V Insulated Tool Set (5 Pcs)**

İZELTAS YOUTUBE



KOD CODE	İÇERİK CONTENTS	☐	TL/Ad.
3020 12 6180	180 mm 1000V İzoleli Elektrikçi Kombine Pense Insulated Electrician Type Combination Pliers 1000V	1	4.344,75
3220 13 6200	200 mm 1000V İzoleli Elektrikçi Kargaburun Insulated Electrician Type Nose Pliers	1	
3700 16 6160	160 mm 1000V İzoleli Elektrikçi Yan Keski Insulated Electrician Type Nose	1	
4140 17 5512	5.5x125 1000V Elektrikçi Düz Uçlu Tornavida Insulated Electrician Type Flat Screwdriver 1000V	1	
4145 18 6100	6x100 1000V İzoleli Elektrikçi Yıldız Uçlu Tornavida Insulated Electrician Type Phillips Screwdriver 1000V	1	



# TORNAVİDA VE ALLEN ANAHTARLAR

SCREWDRIVERS AND HEX KEY WRENCHES

- Kontrol Kalemleri  
Testers
- Torna vidalar  
Screwdrivers
- Allen Anahtarlar  
Hex Key Wrenches



İZELTAS YOUTUBE

## ELEKTRİK KONTROL KALEMİ / VOLTAGE TESTER

**Tam sızdırmazlık sağlayan açılmayan pirinç kapak**  
Tightly pressed brass cover

**110V-220V arasında çalışan elektrik direnci ve kolay görünebilen neon lamba**  
Neon lamp working in the range of 110V-220V

**Elektrik yalıtkanlığı sağlayan, darbe dayanımı yüksek şeffaf sap**  
High insulation and impact resistant clear cellulose handle

**Metal yüzeye basılı logo**  
Logo marked on the innermetal surface

**İzoleli süngü**  
Insulated blade

**Yüksek tork mukavemetine sahip, alaşımlı çelik (izolesiz uç kısmının uzunluğu 15mm)**  
High torque strength alloyed steel (non-insulated blade tip length 15mm)

**Nikel kaplama ile korozyon direncinde üst seviye koruma**  
High corrosion resistance with nickel plating

**Vida yuvalarına tam oturmayı sağlayan hassas işlenmiş uçlar**  
Precise machined slot to mate screw heads

**4550**
**Elektrik Kontrol Kalemı (Düz Uçlu)**  
**Voltage Tester (Flat)**

TS 13108

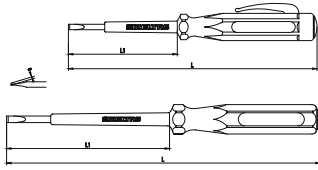
**Krom vanadyum, Nikel kaplı**  
**Chrom vanadium, Nickel plated**

KOD CODE	L mm	⊖		L1 mm	g	□	TL/ Ad.
		a mm	b mm				
4550 17 0135	135	0.5	3	60	25	10	157,50
4550 17 0190	190	0.8	4	100	40	10	201,25

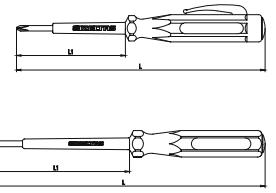
**4560**
**Elektrik Kontrol Kalemı (Yıldız Uçlu)**  
**Voltage Tester (Phillips)**

**Krom vanadyum, Nikel kaplı**  
**Chrom vanadium, Nickel plated**

KOD CODE	L mm	L1 mm	⊕	g	□	TL/ Ad.
4560 18 0190	190	100	Ph0	45	10	237,00

**4565 17 0135**
**Oto Kontrol Kalemı**  
**Car Voltage Tester**

Tüm otomobil ve ağır vasıta araçlarda 6-24V arası elektrik tesisatının kontrol edilmesinde kullanılır. Sivri uçlu olması sebebiyle kablo ve soketleri yerinden sökmeden kontrol kolaylığı sağlar.

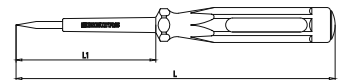
Tool is used to control 6-24V electrical wiring in all cars and heavy duty vehicles. With its point tip, wires and sockets are not required to be disassembled.

**Krom vanadyum, Krom kaplı**  
**Chrom vanadium, Chrom plated**

KOD CODE	L mm	L1 mm	●	Kablo L (m)	g	□	TL/ Ad.
4565 17 0135	135	60	●	1	210	10	423,00

4100

### Kraft Seri Düz Uçlu Tornavida Screwdriver, Kraft, Flat



TS ISO 2380 - 1  
DIN ISO 2380-1

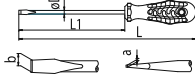

Krom vanadyum, Krom kaplı, Ucu siyah oksit, Selüloz asetat saplı  
Chrom vanadium, Chrom plated and black tip, Cellulose acetate handle

KOD CODE	σDxL1 mm	⊖		L mm	g	□	TL/Ad.
		a mm	b mm				
4100 17 0340	3x40	0.5	3	105	20	10	133,00
4100 17 0380	3x80	0.5	3	155	30	10	141,25
4100 17 0480	4x80	0.8	4	165	45	10	152,00
4100 17 4100	4x100	0.8	4	185	55	10	175,50
4100 17 0580	5x80	1.0	5.5	175	70	10	186,25
4100 17 5100	5x100	1.0	5.5	195	75	10	204,25
4100 17 5125	5x125	1.0	5.5	220	80	10	232,75
4100 17 5150	5x150	1.0	5.5	245	85	10	254,75
4100 17 6100	6x100	1.2	6.5	195	80	10	208,25
4100 17 6125	6x125	1.2	6.5	220	80	10	239,50
4100 17 6150	6x150	1.2	6.5	245	90	10	263,00
4100 17 6175	6x175	1.2	6.5	270	100	10	336,75
4100 17 7125	7x125	1.2	8	230	120	10	265,75
4100 17 7150	7x150	1.2	8	255	125	10	306,75
4100 17 7175	7x175	1.2	8	280	135	10	351,75
4100 17 8150	8x150	1.6	10	255	145	10	349,00
4100 17 8175	8x175	1.6	10	280	150	10	372,25
4100 17 8200	8x200	1.6	10	305	160	10	455,75
4100 17 9200	9x200	2.0	12	305	175	10	484,50
4100 17 1125	11x250	2.5	14	365	315	10	615,75



4100 00 8108

### Kraft Seri Düz Uçlu Tornavida Takımı (8 Parça) Screwdriver, Flat, Kraft Set (8 Pcs)



KOD CODE	İÇERİK CONTENTS	g	□	TL/ Ad.
4100 00 8108	3x80 - 4x80 - 4x100 5x100 - 5x125 - 6x100 6x125 - 6x150 ⊖ Düz uçlu / Flat	685	8	1.616,50

4100

### Kraft Seri Süngüsü Uzun Düz Uçlu Tornavida Screwdriver, Kraft, Flat, Long

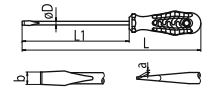

Krom vanadyum, Krom kaplı, Ucu siyah oksit, Selüloz asetat saplı  
Chrom vanadium, Chrom plated and black tip, Cellulose acetate handle

KOD CODE	σDxL1 mm	⊖		L mm	g	□	TL/Ad.
		a mm	b mm				
4100 17 4300	4x300	0.8	4	385	70	10	428,50
4100 17 5250	5x250	1.0	5.5	345	95	10	480,25
4100 17 5350	5x350	1.0	5.5	445	110	10	540,50
4100 17 6350	6x350	1.2	6.5	445	140	10	573,50

4120

**Kraft Seri Yıldız Uçlu Tornavida**  
 Screwdriver, Kraft, Phillips

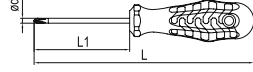
 TS 59 - 5 ISO 8764-1  
 DIN ISO 8764-1

 Krom vanadyum, Krom kaplı, Ucu siyah oksit, Selüloz asetat saplı  
 Chrom vanadium, Chrom plated and black tip, Cellulose acetate handle

KOD CODE	ødxL1 mm	+	L mm	g	□	TL/Ad.
4120 18 0360	3x60	Ph0	135	30	10	149,50
4120 18 4580	4.5x80	Ph1	165	55	10	213,50
4120 18 5100	4.5x100	Ph1	185	50	10	238,50
4120 18 5150	4.5x150	Ph1	235	50	10	284,75
4120 18 6100	6x100	Ph2	195	80	10	256,00
4120 18 6150	6x150	Ph2	245	95	10	306,75
4120 18 6200	6x200	Ph2	295	105	10	398,25
4120 18 8150	8x150	Ph3	255	150	10	485,75
4120 18 1200	10x200	Ph4	315	240	10	750,00

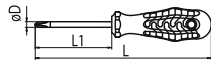
4120

**Kraft Seri Süngüsü Uzun Yıldız Uçlu Tornavida**  
 Screwdriver, Kraft, Phillips, Long

 Krom vanadyum, Krom kaplı, Ucu siyah oksit, Selüloz asetat saplı  
 Chrom vanadium, Chrom plated and black tip, Cellulose acetate handle

KOD CODE	øDxL1 mm	+	L mm	g	□	TL/Ad.
4120 18 5300	4.5x300	Ph1	385	80	10	669,25
4120 18 6300	6x300	Ph2	395	130	10	692,50

4120 00 8106

**Kraft Seri Yıldız Uçlu Tornavida Takımı (6 parça)**  
 Screwdriver, Kraft, Phillips, Set (6 Pcs)

KOD CODE	İÇERİK CONTENTS	g	□	TL/Ad.
4120 00 8106	3x60 - 4.5x80 4.5x100 - 4.5x150 6x100 - 6x150 Yıldız uçlu / Phillips	375	6	1.449,00

4100 00 8107

**Kraft Seri Tornavida Seti (7 parça)**  
 Screwdriver Set, Kraft (7 Pcs)



KOD CODE	İÇERİK CONTENTS	g	□	TL/Ad.
4100 00 8107	3x80 - 4x80 - 4x100 5x125 - 6x150 Düz uçlu / Flat 4.5x80 - 6x100 Yıldız uçlu / Phillips	440	7	1.434,00

4110

**Kraft Seri Düz Uçlu Topaç Tornavida**  
Screwdriver, Kraft, Stubby, Flat

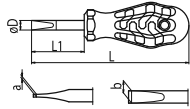

TS ISO 2380-1



Krom vanadyum, Krom kaplı, Ucu siyah oksit, Selüloz asetat saplı  
Chrom vanadium, Chrom plated and black tip, Cellulose acetate handle

KOD CODE	σDxL1 mm	⊖		L mm	g	TL/Ad.	
		a mm	b mm				
4110 17 5525	5.5x25	1	5.5	70	30	5	152,00
4110 17 5540	5.5x40	1	5.5	105	45	5	205,25
4110 17 6525	6.5x25	1.2	6.5	70	35	5	170,00
4110 17 6540	6.5x40	1.2	6.5	105	50	5	232,75

4130

**Kraft Seri Yıldız Uçlu Topaç Tornavida**  
Screwdriver, Kraft, Stubby, Phillips



TS 59-5 ISO 8764

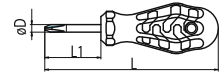

Krom vanadyum, Krom kaplı, Ucu siyah oksit, Selüloz asetat saplı  
Chrom vanadium, Chrom plated and black tip, Cellulose acetate handle

KOD CODE	σDxL1 mm	+	L mm	g	TL/Ad.	
						4130 18 4525
4130 18 4540	4.5x40	Ph1	105	40	5	204,25
4130 18 0625	6x25	Ph2	70	30	5	170,00
4130 18 0640	6x40	Ph2	105	50	5	230,00

13000 005116

**Black Line Düz Uçlu Tornavida**  
Screwdriver, Flat

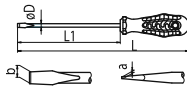
TS ISO 2380-1  
DIN ISO 2380-1

Krom vanadyum, Manganez fosfat kaplı, PP saplı  
Chrom vanadium, Phosphate finish, PP handle

KOD CODE	σDxL1 mm	⊖		L mm	g	TL/Ad.	
		a mm	b mm				
13000 005116	6x100	1.2	6.5	195	65	10	294,25

13000 005120

**Black Line Yıldız Uçlu Tornavida**  
Screwdriver, Phillips

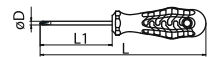
TS 59 - 5 ISO 8764-1  
DIN ISO 8764

Krom vanadyum, Manganez fosfat kaplı, PP saplı  
Chrom vanadium, Phosphate finish, PP handle

KOD CODE	σDxL1 mm	+	L mm	g	TL/Ad.	
						13000 005120

**4140**
**1000V İzoleli Elektrikçi Düz Uçlu Tornavida**  
 Insulated Electrician Type Flat  
 Screwdriver 1000V

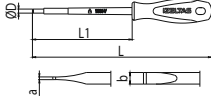
 TS ISO 2380-1  
 DIN ISO 2380-1  
 ⚡ 1000 V  
 IEC 60900

 Krom vanadyum, Siyah oksit kaplı  
 Chrom vanadium, Black finish

KOD CODE	øDxL1 mm	⊖		L mm	g	□	TL/Ad.
		a mm	b mm				
4140 17 2575	2.5x75	0.4	2.5	150	30	10	170,00
4140 17 4100	4x100	0.8	4	185	45	10	198,50
4140 17 5512	5.5x125	1	5.5	220	75	10	261,50
4140 17 6515	6.5x150	1.2	6.5	245	90	10	291,75

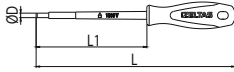
**4145**
**1000V İzoleli Elektrikçi Yıldız Uçlu Tornavida**  
 Insulated Electrician Type Phillips  
 Screwdriver 1000V

 TS 59-5 ISO 8764  
 DIN ISO 8764  
 ⚡ 1000 V  
 IEC 60900

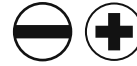
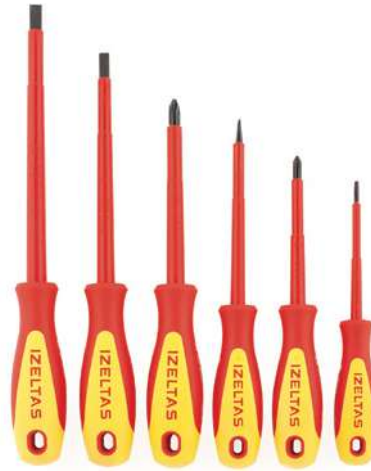
 Krom vanadyum, Siyah oksit kaplı  
 Chrom vanadium, Black finish

KOD CODE	øDxL1 mm	+	L mm	g	□	TL/Ad.
4145 18 4580	4.5x80	Ph1	165	50	10	249,25
4145 18 6100	6x100	Ph2	195	80	10	291,75

**4140 00 9106**
**1000V İzoleli Elektrikçi Tornavida Seti (6 Parça)**  
 Insulated Electrician Set (6 Pcs) Screwdriver 1000V

KOD CODE	İÇERİK CONTENTS	g	□	TL/ Ad.
4140 00 9106	2.5x75 - 4x100	380	6	1.462,75
	⊖ 5.5x125 - 6.5x150			
	Düz uçlu / Flat			
	⊕ 4.5x80 - 6x100			
	Yıldız uçlu / Phillips			



14000 005342

### 1000V İzoleli Elektro Slim Tornavida Seti (14 Parça) Insulated Electro Slim Screwdriver Set 1000V (14 Pcs)

**ELEKTROSLIM**

KOD CODE	İÇERİK CONTENTS	g		TL/Ad
14000 005342	1000V İzoleli Elektro Slim Düz Uçlu Tornavida 2.5x75 - 3x100 - 3.5x100 - 4x100 - 5.5x100 - 6.5x100 Insulated Electro Slim Type Flat Screwdriver 1000V		6	
	1000V İzoleli Elektro Slim Yıldız Uçlu Tornavida Ph1 - Ph2 Insulated Electro Slim Type Phillips Screwdriver 1000V		2	
	1000V İzoleli Elektro Slim Pozidriv Yıldız Uçlu Tornavida Pz2 Insulated Electro Slim Type Phillips Pozidriv Screwdriver 1000V	840	1	3.414,75
	1000V İzoleli Elektro Slim Torx® Uçlu Tornavida T10 - T15 - T20 Insulated Electro Slim Type Torx® Screwdriver 1000V		3	
	1000V İzoleli Elektro Slim Oto Tornavida Sap Insulated Electro Slim Screwdriver Handle 1000V		1	
	1000V İzoleli Elektro Slim tornavida Klemens Tutucu Başlık Insulated Electro Slim Screwdriver Head 1000V		1	

14000 005335

### 1000V İzoleli Elektro Slim Oto Tornavida Sap Insulated Electro Slim Screwdriver Handle 1000V

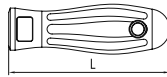
 $\triangleq$  1000 V  
IEC 60900

KOD CODE	L mm	g		TL/Ad
14000 005335	100	55	1	216,50

14000 005334

### 1000V İzoleli Elektro Slim Klemens Tutucu Başlık Insulated Electro Slim Screwdriver Head 1000V

 $\triangleq$  1000 V  
IEC 60900

KOD CODE	g		TL/Ad
14000 005334	5	10	22,00

### 1000V İzoleli Elektro Slim Düz Uçlu Tornavida Insulated Electro Slim Type Flat Screwdriver 1000V

⚡1000 V  
IEC 60900

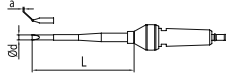

KOD CODE	Ød x L mm	a mm	g	TL/Ad
14000 005328	2.5x75	0,4	35	1 182,25
14000 005330	3x100	0,5	40	1 189,00
14000 005329	3.5x100	0,6	40	1 189,00
14000 005331	4x100	0,6	40	1 189,00
14000 005332	5.5x100	1	45	1 208,25
14000 005333	6.5x100	1,2	55	1 208,25

### 1000V İzoleli Elektro Slim Torx® Uçlu Tornavida Insulated Electro Slim Type Torx® Screwdriver 1000V

⚡1000 V  
IEC 60900

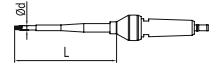

KOD CODE	Ød x L mm	T	g	TL/Ad
14000 005336	3,5x100	T10	40	1 189,00
14000 005337	3,5x100	T15	40	1 189,00
14000 005338	4,5x100	T20	40	1 189,00

### 1000V İzoleli Elektro Slim Yıldız Uçlu Tornavida Insulated Electro Slim Type Phillips Screwdriver 1000V

⚡1000 V  
IEC 60900

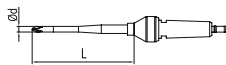

KOD CODE	Ød x L mm	Ph	g	TL/Ad
14000 005339	4,5x80	Ph1	40	1 198,50
14000 005340	6x100	Ph2	50	1 198,50

### 1000V İzoleli Elektro Slim Pozidriv Yıldız Uçlu Tornavida Insulated Electro Slim Type Phillips Pozidriv Screwdriver 1000V

⚡1000 V  
IEC 60900

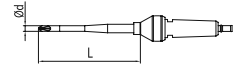

KOD CODE	Ød x L mm	Pz	g	TL/Ad
14000 005341	6x100	Pz2	50	1 198,50

4300

### Opak Seri Düz Uçlu Tornavida

Screwdriver, Opak, Flat



TS ISO 2380-1  
DIN ISO 2380-1

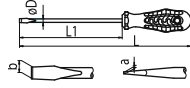

Krom vanadyum, Krom kaplı, Ucu siyah oksit, PP saplı  
Chrom vanadium, Chrom plated and black tip, PP handle

KOD CODE	σDxL1 mm	⊖		L mm	g	□	TL/Ad.
		a mm	b mm				
4300 17 0380	3x80	0.5	3	155	25	10	123,25
4300 17 0480	4x80	0.8	4	165	30	10	129,00
4300 17 4100	4x100	0.8	4	185	40	10	152,00
4300 17 5100	5x100	1.0	5.5	195	55	10	183,75
4300 17 5125	5x125	1.0	5.5	220	60	10	213,50
4300 17 6100	6x100	1.2	6.5	195	65	10	191,75
4300 17 6125	6x125	1.2	6.5	220	70	10	217,75
4300 17 6150	6x150	1.2	6.5	245	80	10	238,50
4300 17 7125	7x125	1.2	8	230	95	10	243,75
4300 17 7150	7x150	1.2	8	255	105	10	280,50
4300 17 8175	8x175	1.6	10	280	130	10	339,50
4300 17 9200	9x200	2.0	12	305	165	10	447,50

4320

### Opak Seri Yıldız Uçlu Tornavida

Screwdriver, Opak, Phillips



TS 59 - 5 ISO 8764-1  
DIN ISO 8764



Krom vanadyum, Krom kaplı, Ucu siyah oksit, PP saplı  
Chrom vanadium, Chrom plated and black tip, PP handle

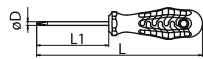

KOD CODE	σDxL1 mm	+	L mm	g	□	TL/Ad.
4320 18 4580	4.5x80	Ph1	165	40	10	193,00
4320 18 6100	6x100	Ph2	195	70	10	234,00
4320 18 8150	8x150	Ph3	255	130	10	442,25

4300 00 8107

### Opak Seri Tornavida Seti (7 Parça)

Screwdriver Set, Opak (7 Pcs)

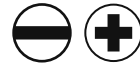

KOD CODE	İÇERİK CONTENTS	g	□	TL/Ad.

4325

### Opak Seri Pozidriv Yıldız Uçlu Tornavida

Screwdriver, Opak, Pozidriv

TS 59 - 5 ISO 8764-1  
DIN ISO 8764



Krom vanadyum, Krom kaplı, Ucu siyah oksit, PP saplı  
Chrom vanadium, Chrom plated and black tip, PP handle

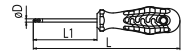

KOD CODE	σDxL1 mm	+	L mm	g	□	TL/Ad.
4325 18 4580	4.5x80	Pz1	165	40	10	213,50
4325 18 6100	6x100	Pz2	195	70	10	256,00
4325 18 8150	8x150	Pz3	255	125	10	485,75

**4240 17 0680**
**Değişken Uçlu Tornavida**  
 Screwdriver - Reversible

TSEK

 Krom vanadyum, Krom kaplı, Selüloz asetat saplı  
 Chrom vanadium, Chrom plated, Cellulose acetate handle

KOD CODE	σDxL1 mm	⊖ axb mm	⊕	L mm	g	TL/Ad.
4240 17 0680	6x80	1.2x6	Ph2	175	85	10 268,25

**4240 00 7102**
**Değişken Uçlu Tornavida Takımı**  
 Screwdriver Set - Reversible

TSEK



KOD CODE	σDxL1 mm	⊖	⊕	L mm	g	TL/Ad.
		axb mm				
4240 00 7102	6x80	1.2x6	Ph2	175	135	1 459,75
	4.5x80	0.65x4.5	Ph1			

**4500**
**Elektronikçi Tip (Klemens) Düz Uçlu Tornavida**  
 Electronic Screwdriver, Flat

 Krom vanadyum, Krom kaplı, Ucu siyah oksit, PP saplı  
 Chrom vanadium, Chrom plated and black tip, PP handle

KOD CODE	σDxL1 mm	⊖		L mm	g	TL/Ad.
		a mm	b mm			
4500 17 2560	2.5x60	0.4	2.5	140	15	10 119,25
4500 17 2580	2.5x80	0.4	2.5	160	15	10 126,00
4500 17 0380	3x80	0.5	3	160	15	10 133,00
4500 17 3100	3x100	0.5	3	180	10	10 163,25
4500 17 3125	3x125	0.5	3	205	10	10 213,50
4500 17 3510	3.5x100	0.6	3.5	180	20	10 167,25
4500 17 0480	4x80	0.8	4	160	20	10 137,00
4500 17 4100	4x100	0.8	4	180	25	10 167,25
4500 17 4125	4x125	0.8	4	205	25	10 224,75
4500 17 4150	4x150	0.8	4	230	25	10 243,75

**4520**
**Elektronikçi Tip (Klemens) Yıldız Uçlu Tornavida**  
 Electronic Screwdriver, Phillips

 Krom vanadyum, Krom kaplı, Ucu siyah oksit, PP saplı  
 Chrom vanadium, Chrom plated and black tip, PP handle

KOD CODE	σDxL1 mm	⊕	L mm	g	TL/Ad.
4520 18 0360	3x60	Ph0	140	15	10 141,25
4520 18 0480	4x80	Ph0	160	20	10 201,25
4520 18 4150	4x150	Ph0	230	25	10 268,25

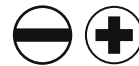
**4500 00 8106**
**Elektronikçi Tip (Klemens) Tornavida Seti (6 Parça)**  
 Electronic Screwdriver Set (6 Pcs)

KOD CODE	İÇERİK CONTENTS	g	TL/Ad.
4500 00 8106	3x80 - 3x100	205	6 1.096,00
	3x125 - 4x150		
	Düz uçlu / Flat		
	3x60 - 4x80		
	Yıldız uçlu / Phillips		

4530

### Elektronikçi Tip (Klemens) Torx® Uçlu Tornavida Electronic Screwdriver, Torx®

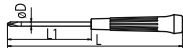

Krom vanadyum, Krom kaplı, Ucu siyah oksit, PP saplı  
Chrom vanadium, Chrom plated and black tip, PP handle

KOD CODE	σDxL1 mm	★	L mm	g	□	TL/Ad.
4530 17 0560	2.5x60	T5	145	15	10	163,25
4530 17 0660	2.5x60	T6	145	15	10	163,25
4530 17 0760	3x60	T7	145	15	10	168,50
4530 17 0860	3x60	T8	145	15	10	168,50
4530 17 0960	3x60	T9	145	15	10	168,50
4530 17 1060	3.5x60	T10	145	15	10	168,50

4530 00 1006

### Elektronikçi Tip (Klemens) Torx® Uçlu Tornavida Takımı (6 Parça) Electronic Screwdriver Set Torx® (6 Pcs)



KOD CODE	İÇERİK CONTENTS	g	□	TL/Ad.
4530 00 1006	T5 - T6 - T7 - T8 - T9 - T10	85	6	1.000,50

4540 19 0190

### Klips Sökme Tornavidası Hupcap and Clip Remover

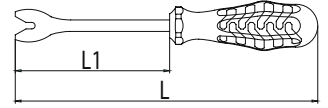

Krom vanadyum, Krom kaplı, PP Saplı  
Chrom vanadium, Chrom plated, PP insulated

KOD CODE	L mm	L1 mm	g	□	TL/Ad.
4540 19 0190	290	180	160	10	657,00

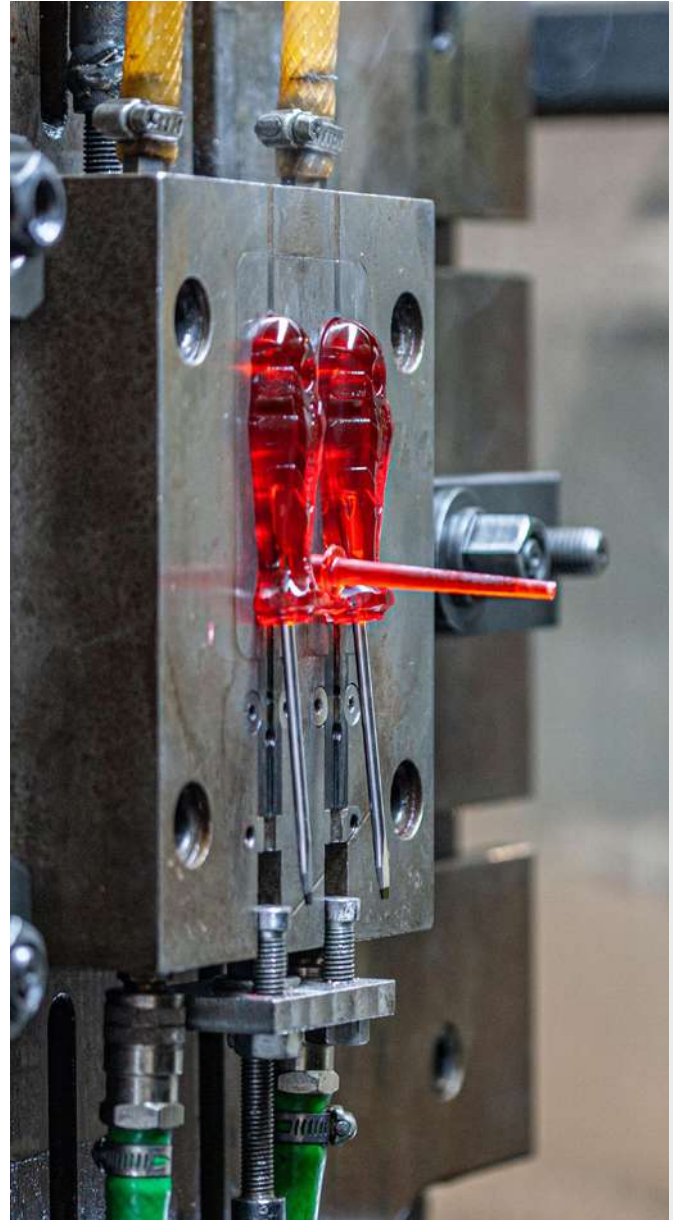

4765

**T Tipi Lokma Uçlu Tornavida (mm)**  
Nut Spinner With T-Handle (mm)

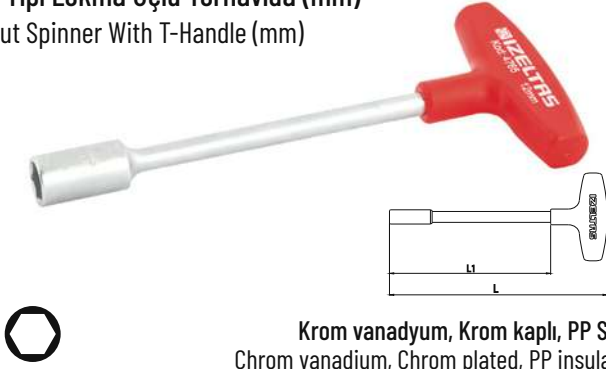

Krom vanadyum, Krom kaplı, PP Saplı  
Chrom vanadium, Chrom plated, PP insulated

KOD CODE	mm	L mm	L1 mm	g		TL/Ad.
4765 19 0040	4	185	135	50	10	341,00
4765 19 0050	5	185	135	55	10	341,00
4765 19 0055	5.5	185	135	55	10	341,00
4765 19 0060	6	185	135	65	10	341,00
4765 19 0070	7	185	135	80	10	362,75
4765 19 0080	8	185	135	85	10	362,75
4765 19 0090	9	185	135	85	10	403,75
4765 19 0100	10	185	135	85	10	403,75
4765 19 0110	11	185	135	105	10	444,75
4765 19 0120	12	185	135	110	10	459,75
4765 19 0130	13	185	135	110	10	480,25
4765 19 0140	14	185	135	120	10	558,50

4770

**Lokma Uçlu Tornavida (mm)**  
Nut Spinner (mm)

TS 3793  
DIN 3125



Krom vanadyum, Krom kaplı, PP Saplı  
Chrom vanadium, Chrom plated, PP insulated

KOD CODE	mm	L mm	L1 mm	g		TL/Ad.
4770 19 0040	4	220	125	65	10	387,50
4770 19 0050	5	220	125	60	10	387,50
4770 19 0055	5.5	220	125	65	10	387,50
4770 19 0060	6	220	125	80	10	387,50
4770 19 0070	7	230	125	100	10	416,25
4770 19 0080	8	230	125	100	10	416,25
4770 19 0090	9	230	125	115	10	447,50
4770 19 0100	10	230	125	115	10	447,50
4770 19 0110	11	230	125	130	10	490,00
4770 19 0120	12	230	125	135	10	525,75
4770 19 0130	13	230	125	135	10	565,25
4770 19 0140	14	230	125	145	10	625,50



4770 00 8108

**Lokma Uçlu Tornavida Takımı (8 Parça, mm)**  
Nut Spinner Set (8 Pcs, mm)



KOD CODE	İÇERİK CONTENTS	g		TL/Ad.
4770 00 8108	6 - 7 - 8 - 9 - 10 - 11 - 12 - 13	1060	8	3.696,00

4773

1000V Sngs İzoleli Lokma Uçlu Tornavida (mm)  
Nut Spinner, Electrician Blade Insulated 1000V

± 1000 V  
IEC 60900



Krom vanadyum, İki Komponent Saplı  
Chrom vanadium, Two Component Insulated

KOD CODE	Ø mm	L mm	L1 mm	g	TL/Ad.	
4773 19 0040	4	220	125	75	10	548,75
4773 19 0050	5	220	125	75	10	548,75
4773 19 0055	5.5	220	125	80	10	548,75
4773 19 0060	6	220	125	90	10	548,75
4773 19 0070	7	230	125	120	10	588,25
4773 19 0080	8	230	125	120	10	588,25
4773 19 0090	9	230	125	125	10	635,00
4773 19 0100	10	230	125	125	10	635,00
4773 19 0110	11	230	125	140	10	692,50
4773 19 0120	12	230	125	140	10	743,00
4773 19 0130	13	230	125	150	10	800,50
4773 19 0140	14	230	125	160	10	885,25

4773 00 8108

1000V Sngs İzoleli Lokma Uçlu Tornavida Takımı  
(8 Parça, mm)

Nut Spinner, Electrician Blade Insulated Set 1000V (8 Pcs, mm)



KOD CODE	İÇERİK CONTENTS	g	TL/Ad.	
4773 00 8108	6 - 7 - 8 - 9 - 10 - 11 - 12 - 13	2225	8	5.231,25

4775

Torx® Uçlu Tornavida  
Torx® Screwdriver

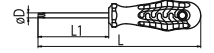

Krom vanadyum, Krom kaplı, Ucu siyah oksit, PP saplı  
Chrom vanadium, Chrom plated and blackened, PP handle

KOD CODE	ØDxL1 mm	TL/Ad.	L mm	g	TL/Ad.	
4775 18 0010	4x80	T10	165	35	10	193,00
4775 18 0015	4x80	T15	165	35	10	193,00
4775 18 0020	4x100	T20	185	40	10	213,50
4775 18 0025	4.5x100	T25	185	40	10	247,75
4775 18 0027	5x125	T27	220	60	10	272,50
4775 18 0030	6x125	T30	220	70	10	288,75
4775 18 0040	7x125	T40	230	100	10	360,00
4775 18 0045	8x125	T45	230	120	10	406,50

4775 00 8107

Torx® Uçlu Tornavida Takımı (7 Parça)  
Torx® Screwdriver Set (7 Pcs)



KOD CODE	İÇERİK CONTENTS	g	TL/Ad.	
4775 00 8107	T10 - T15 - T20 - T25 - T27 - T30 - T40	385	7	1.768,50

4776

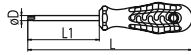
 Delikli Torx® Uçlu Tornavida  
 Torx® Screwdriver / Tamper Resistance

 Krom vanadyum, Krom kaplı, Ucu siyah oksit, PP saplı  
 Chrom vanadium, Chrom plated and blackened, PP handle

KOD CODE	σDxL1 mm		L mm	g		TL/Ad.
4776 18 0009	4x60	TR9	145	35	10	250,75
4776 18 0010	4x80	TR10	165	35	10	259,00
4776 18 0015	4x80	TR15	165	35	10	259,00
4776 18 0020	4x100	TR20	185	40	10	288,75
4776 18 0025	4.5x100	TR25	185	45	10	332,75
4776 18 0027	5x125	TR27	220	60	10	367,00
4776 18 0030	6x125	TR30	220	70	10	390,00
4776 18 0040	7x125	TR40	230	100	10	481,75

4776 00 8107

 Delikli Torx® Uçlu Tornavida Takımı (7 Parça)  
 Torx® Screwdriver / Tamper Resistance Set (7 Pcs)

KOD CODE	İÇERİK CONTENTS	g		TL/Ad.
4776 00 8107	TR10 - TR15 - TR20 - TR25 - TR27 TR30 - TR40	510	7	2.378,25

4780 19 6120

 Manyetik Bits Tutucu Tornavida (Uzun)  
 Screwdriver, Magnetic Bit Holder (Long)

KOD CODE	mm	L mm	L1 mm	g		TL/Ad.
4780 19 6120	6.3	230	120	105	10	498,25

4783 19 6120

 1000V Süngüsü İzoleli Manyetik Bits Tutucu Tornavida  
 Screwdriver, Magnetic Bit Holder Insulated 1000V

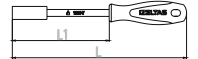
 1000 V  
 IEC 60900

KOD CODE	mm	L mm	L1 mm	g		TL/Ad.
4783 19 6120	6.3	230	120	120	10	617,25

4785 19 6330

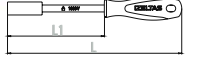
 Manyetik Bits Tutucu Tornavida (Kısa)  
 Screwdriver, Magnetic Bit Holder (Short)

KOD CODE	mm	L mm	L1 mm	g		TL/Ad.
4785 19 6330	6.3	130	30	55	10	272,50

4790 26 6360

 Üniversal Bits Adaptörü (Manyetik)  
 Screwdriver Universal Bit Holder (Magnetic)

KOD CODE	mm	mm	L mm	g		TL/Ad.
4790 26 6360	6.3	6.3	60	20	10	238,50

4795 19 0010

T Tipi Manyetik Bits Tutucu Tornavida  
Magnetic Bit Holder With T-Handle



KOD CODE	mm	L mm	L1 mm	g		TL/Ad.
4795 19 0010	6.3	180	130	85	10	528,25

4788 19 6160

Manyetik Bits Tutucu Tornavida, Flexible  
Screwdriver, Magnetic Bit Holder, Flexible

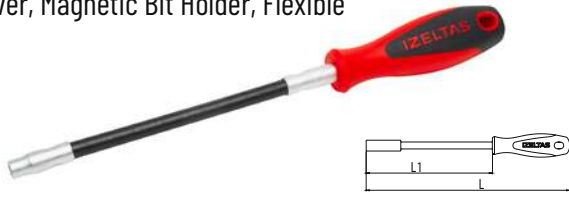

KOD CODE	mm	L mm	L1 mm	g		TL/Ad.
4788 19 6160	6.3	285	175	140	10	1.033,00

4805 20 5010

Bits Uç Lokma Adaptörü (Makine Kullanımına Uygun)  
Socket Adapter



KOD CODE		L mm	g		TL/Ad.
4805 20 5010	1/4"M - 1/4"M	50	15	10	86,50

4815 00 6107

Değişken Bits Uçlu Tornavida Set (7 parça)  
Screwdriver - Interchangeable Bits Set (7 pcs)



KOD CODE	İÇERİK CONTENTS	g		TL/ Ad.
4815 00 6107	100mm Sap - Handle Ph1x4.5 - Ph2x5.5 - Ph3x7 Pz1x4.5 - Pz2x5.5 - Pz3x7	135	7	573,50

13000 005429

Cırcırlı Manyetik Bits Uç Tutucu Tornavida Seti (8 Parça)  
Multi Bit Ratcheting Screwdriver Set (8 Pcs)



KOD CODE	İÇERİK CONTENTS	g		TL/Ad.
	6'lı Bits Set Bit Set (6 Pcs)			
	0.6x4.5 - 0.8x5.5		6	
	Ph1 - Ph2 - Ph3			
	T27			
		230		1.073,25
13000 005278	Cırcırlı Manyetik Bits Tutucu Tornavida (175mm) Ratcheting Screwdriver (175mm)		1	
4790 26 6360	Üniversal Bits Adaptörü (Manyetik) Screwdriver Universal Bit Holder (Magnetic)		1	

13000 005278

Cırcırlı Manyetik Bits Uç Tutucu Tornavida  
Ratcheting Screwdriver



KOD CODE	mm	L mm	g		TL/Ad.
13000 005278	6.3	175	145	5	632,25

**4900**
**Allen Anahtar Altı Köşe Standart Boy (mm)**  
**Hex Key Wrench Standard Size (mm)**

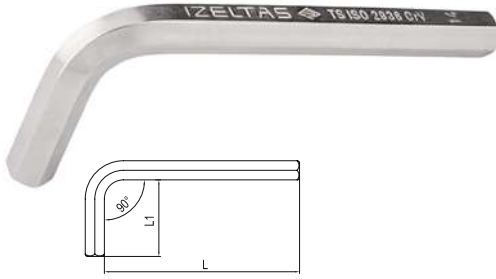
 TS ISO 2936  
 DIN ISO 2936

**Krom Vanadyum, Nikel Kaplı**  
**Chrom Vanadium, Nickel Plated**

KOD CODE	mm	L mm	L1 mm	g	TL/Ad.	
4900 22 0015	1.5	45	14	5	10	18,00
4900 22 0020	2	50	16	5	10	25,00
4900 22 0025	2.5	56	18	5	10	31,75
4900 22 0030	3	63	20	5	10	33,25
4900 22 0035	3.5	66	22	5	10	42,50
4900 22 0040	4	70	25	10	10	42,50
4900 22 0050	5	80	28	15	10	49,50
4900 22 0060	6	90	32	30	10	64,50
4900 22 0070	7	95	34	40	10	94,75
4900 22 0080	8	100	36	55	10	108,50
4900 22 0090	9	105	38	75	10	133,00
4900 22 0100	10	112	40	100	10	164,25
4900 22 0120	12	125	45	160	10	237,00
4900 22 0140	14	140	56	250	5	377,75
4900 22 0160	16	152	60	360	5	695,25
4900 22 0170	17	160	63	430	5	750,00
4900 22 0190	19	180	70	600	5	926,25
4900 22 0220	22	200	80	750	5	1.547,50
4900 22 0240	24	224	90	1215	5	2.086,25

**4900**
**Allen Anahtar Takım Altı Köşe Standart Boy (mm)**  
**Hex Key Wrench Set Standard Size (mm)**

**YENİ TASARIM**  
**NEW DESIGN**

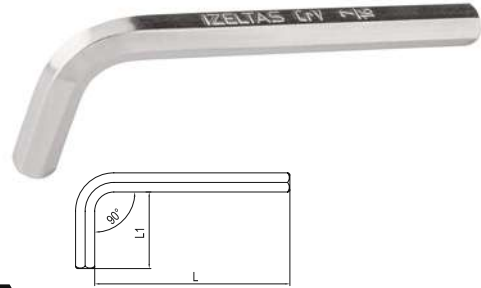
KOD CODE	İÇERİK CONTENTS	g	TL/Ad.	
4900 00 3110	2 - 2.5 - 3 - 4 - 5 - 6 7 - 8 - 9 - 10	405	10	747,00
4900 00 3112	2 - 2.5 - 3 - 3.5 - 4 - 5 6 - 7 - 8 - 9 - 10 - 12	545	12	1.026,50

**4901**
**Allen Anahtar Altı Köşe (SAE)**  
**Hex Key Wrench (SAE)**

**Krom Vanadyum, Nikel Kaplı**  
**Chrom Vanadium, Nickel Plated**

KOD CODE	inch	L mm	L1 mm	g	TL/Ad.	
4901 22 1984	5/64"	50	16	5	10	33,25
4901 22 2381	3/32"	54	18	5	10	35,75
4901 22 3125	1/8"	58	20	5	10	44,00
4901 22 3968	5/32"	62	22	10	10	52,25
4901 22 4762	3/16"	68	24	15	10	54,75
4901 22 5556	7/32"	74	26	25	10	71,25
4901 22 6350	1/4"	82	28	30	10	88,00
4901 22 7937	5/16"	94	32	55	10	108,50
4901 22 9825	3/8"	106	38	90	10	149,50
4901 22 1111	7/16"	118	42	130	10	200,00
4901 22 1270	1/2"	132	46	190	10	250,75
4901 22 1428	9/16"	144	52	265	10	365,50
4901 22 1587	5/8"	156	58	360	10	566,75
4901 22 1905	3/4"	176	66	600	5	792,50

**4901**
**Allen Anahtar Takım Altı Köşe (SAE)**  
**Hex Key Wrench Set (SAE)**

KOD CODE	İÇERİK CONTENTS	g	TL/Ad.	
4901 00 3110	5/64" - 3/32" - 1/8" - 5/32" 3/16" - 7/32" - 1/4" - 5/16" 3/8" - 7/16"	410	10	837,25
4901 00 3112	5/64" - 3/32" - 1/8" - 5/32" 3/16" - 7/32" - 1/4" - 5/16" 3/8" - 7/16" - 1/2" - 9/16"	860	12	1.453,50

4903

Allen Anahtar Altı Köşe Uzun Boy (mm)  
Hex Key Wrench Long Pattern (mm)



TS ISO 2936  
DIN ISO 2936



Krom Vanadyum, Nikel Kaplı  
Chrom Vanadium, Nickel Plated

KOD CODE	mm	L mm	L1 mm	g	TL/Ad.	
4903 22 0020	2	100	16	10	10	35,75
4903 22 0025	2.5	112	18	10	10	42,50
4903 22 0030	3	126	20	10	10	48,00
4903 22 0035	3.5	136.5	22	20	10	59,00
4903 22 0040	4	140	25	30	10	60,50
4903 22 0050	5	160	28	60	10	67,50
4903 22 0060	6	180	32	70	10	108,50
4903 22 0070	7	190	34	100	10	160,25
4903 22 0080	8	200	36	130	10	174,00
4903 22 0090	9	210	38	180	10	235,50
4903 22 0100	10	224	40	280	10	291,75
4903 22 0120	12	250	45	280	10	417,25
4903 22 0140	14	280	56	430	5	671,75
4903 22 0160	16	290	60	595	5	1.086,50
4903 22 0170	17	320	63	740	5	1.183,50
4903 22 0190	19	360	70	1040	5	1.752,50

4903

Allen Anahtar Takım Altı Köşe Uzun Boy (mm)  
Hex Key Wrench Set Long Pattern (mm)



YENİ TASARIM  
NEW DESIGN



KOD CODE	İÇERİK CONTENTS	g	TL/Ad.	
4903 00 3110	2 - 2.5 - 3 - 4 - 5 - 6 7 - 8 - 9 - 10	710	10	1.224,25
4903 00 3112	2 - 2.5 - 3 - 3.5 - 4 - 5 6 - 7 - 8 - 9 - 10 - 12	920	12	1.700,50

4905

Yuvarlak Başlı Allen Anahtar Standart Boy (mm)  
Hex Key Wrench Ballpoint (mm)



Krom Vanadyum, Nikel Kaplı  
Chrom Vanadium, Nickel Plated

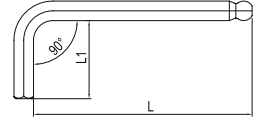

KOD CODE	mm	L mm	L1 mm	g	TL/Ad.	
4905 22 0020	2	50	16	10	10	40,00
4905 22 0025	2.5	56	18	10	10	48,00
4905 22 0030	3	63	20	10	10	54,75
4905 22 0040	4	70	25	20	10	67,50
4905 22 0050	5	80	28	20	10	71,25
4905 22 0060	6	90	32	30	10	113,75
4905 22 0080	8	100	36	60	10	174,00
4905 22 0100	10	112	40	100	10	276,50

4905 00 7108

Yuvarlak Başlı Allen Anahtar Takımı Standart Boy  
(8 Parça, mm)  
Hex Key Wrench Ballpoint Set (8 Pcs, mm)

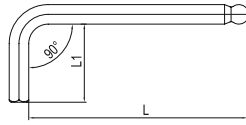

KOD CODE	İÇERİK CONTENTS	g	TL/Ad.	
4905 00 7108	2 - 2.5 - 3 - 4 5 - 6 - 8 - 10	240	8	845,75

**4906**
**Yuvarlak Başlı Allen Anahtar Uzun Boy (mm)**  
 Hex Key Wrench Ballpoint Long Pattern (mm)

**Krom Vanadyum, Nikel Kaplı**  
 Chrom Vanadium, Nickel Plated

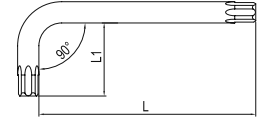
KOD CODE	mm	L mm	L1 mm	g	TL/ Ad.
4906 22 0015	1.5	79	12	5	53,75
4906 22 0020	2	84	16	5	71,25
4906 22 0025	2.5	89	16	5	76,75
4906 22 0030	3	99	18	5	82,25
4906 22 0040	4	109	23	15	94,75
4906 22 0050	5	125	26	25	117,75
4906 22 0060	6	150	28	35	135,75
4906 22 0080	8	167	33	85	215,00
4906 22 0100	10	190	37	130	319,00

**4910**
**Torx® Allen Anahtar**  
 Torx® Key Wrench

**Krom Vanadyum, Nikel Kaplı**  
 Chrom Vanadium, Nickel Plated

KOD CODE	☆	L mm	L1 mm	g	TL/ Ad.
4910 22 0006	T6	42	16	5	164,25
4910 22 0007	T7	48	16	5	164,25
4910 22 0008	T8	48	16	5	164,25
4910 22 0009	T9	48	16	5	165,75
4910 22 0010	T10	51	17	5	165,75
4910 22 0015	T15	54	18	5	170,00
4910 22 0020	T20	57	19	5	179,50
4910 22 0025	T25	60	20	10	179,50
4910 22 0027	T27	64	21	15	179,50
4910 22 0030	T30	70	24	20	191,75
4910 22 0040	T40	76	26	30	204,25
4910 22 0045	T45	83	29	45	249,25
4910 22 0050	T50	95	32	60	283,50
4910 22 0055	T55	108	35	125	392,75
4910 22 0060	T60	120	38	185	540,50

**4906 00 3109**
**Yuvarlak Başlı Allen Anahtar Takım Uzun Boy (9 parça, mm)**  
 Hex Key Wrench Ballpoint Long Pattern Set (9 Pcs, mm)

KOD CODE	İÇERİK CONTENTS	g	TL/ Ad.
4906 00 3109	1.5 - 2 - 2.5 - 3 - 4 - 5 - 6 8 - 10	380	9 1.166,25

**4910 00 7108**
**Torx® Allen Anahtar Takımı (8 Parça)**  
 Torx® Key Wrench Set (8 Pcs)

KOD CODE	İÇERİK CONTENTS	g	TL/ Ad.
4910 00 7108	T9 - T10 - T15 T20 - T25 - T27 T30 - T40	120	8 1.436,00

4912 00 3107

Kaset Allen Anahtar Takımı (7 Parça, mm)  
Hex Key Wrench Folding Set (7 Pcs, mm)



Krom vanadyum  
Chrom vanadium

KOD CODE	İÇERİK CONTENTS	g	TL/ Ad.
4912 00 3107	2.5 - 3 - 4 - 5 - 6 - 8 - 10	355	1.440,75

4912 00 0007

Kaset Allen Anahtar Takımı (7 Parça, mm)  
Hex Key Wrench Folding Set (7 Pcs, mm)



Krom vanadyum  
Chrom vanadium

KOD CODE	İÇERİK CONTENTS	g	TL/ Ad.
4912 00 0007	1.5 - 2 - 2.5 3 - 4 - 5 - 6	120	914,00

4909

T Tipi Torx® Allen Anahtar  
T Handle Torx® Key Wrench

YENİ TASARIM  
NEW DESIGN

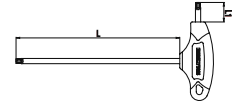

Krom vanadyum, Nikel kaplı, PP Saplı  
Chrom vanadium, Nickel plated, PP Handle

KOD CODE	★	L mm	L1 mm	g	TL/ Ad.
4909 22 0009	T9	111.5	21	20	5 417,25
4909 22 0010	T10	111.5	21	15	5 425,75
4909 22 0015	T15	105	16	25	5 435,25
4909 22 0020	T20	105	16	25	5 438,00
4909 22 0025	T25	129	25	45	5 447,50
4909 22 0027	T27	129	25	65	5 498,25
4909 22 0030	T30	122	20	75	5 512,00
4909 22 0040	T40	153	35	110	5 531,00

4909 00 8108

T Tipi Torx® Allen Anahtar Takımı (8 Parça)  
T Handle Torx® Key Wrench Set (8 Pcs)



KOD CODE	İÇERİK CONTENTS	g	TL/ Ad.
4909 00 8108	T9 - T10 - T15 - T20 T25 - T27 - T30 - T40	505	8 3.705,00

**4920**
**T Tipi Allen Anahtar (mm)**  
 Hex Key Wrench T - Handle (mm)

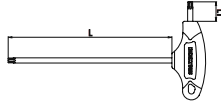
**YENİ TASARIM**  
 NEW DESIGN

 Krom Vanadyum, Krom Kaplı, PP Saplı  
 Chrom Vanadium, Chrom Plated, PP Handle

KOD CODE	mm	L mm	L1 mm	g	TL/Ad.	
4920 22 0025	2.5	102	17.5	20	5	225,75
4920 22 0030	3	118	21	20	5	230,00
4920 22 0040	4	131	24.5	40	5	259,00
4920 22 0050	5	141	22	60	5	275,25
4920 22 0060	6	154	26	90	5	314,75
4920 22 0070	7	174	36	120	5	329,75
4920 22 0080	8	184	34	170	5	388,75
4920 22 0100	10	209	45.5	260	5	587,25

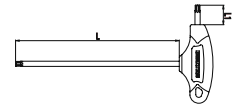
**4921**
**T Tipi Yuvarlak Başlı Allen Anahtar (mm)**  
 Hex Key Wrench T - Handle Ballpoint (mm)

**YENİ TASARIM**  
 NEW DESIGN

 Krom Vanadyum  
 Chrom Vanadium

KOD CODE	mm	L mm	L1 mm	g	TL/Ad.	
4921 22 0025	2.5	102	17.5	10	5	293,00
4921 22 0030	3	118	21	15	5	297,00
4921 22 0040	4	131	24.5	30	5	332,75
4921 22 0050	5	141	22	55	5	357,25
4921 22 0060	6	154	26	80	5	409,50
4921 22 0070	7	174	36	110	5	428,50
4921 22 0080	8	184	34	160	5	459,75
4921 22 0100	10	209	45.5	260	5	762,25

**4920 00 8108**
**T Tipi Allen Anahtar Takımı (8 Parça, mm)**  
 Hex Key Wrench T - Handle Set (8 Pcs, mm)

KOD CODE	İÇERİK CONTENTS	g	TL/Ad.	
4920 00 8108	2.5 - 3 - 4 - 5 6 - 7 - 8 - 10	940	8	2.610,50

**4921 00 8108**
**T Tipi Yuvarlak Başlı Allen Anahtar Takımı (8 Parça, mm)**  
 Hex Key Wrench T - Handle Ballpoint Set (8 Pcs, mm)



KOD CODE	İÇERİK CONTENTS	g	TL/Ad.	
4921 00 8108	2.5 - 3 - 4 5 - 6 - 7 - 8 - 10	740	8	3.340,00



### 1000V İzoleli T Tipi Allen Anahtar (mm) Hex Key Wrench T - Handle Insulated 1000V

**YENİ TASARIM  
NEW DESIGN**

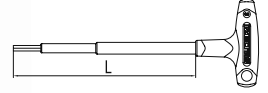
⚡ 1000 V  
IEC 60900



● Krom vanadyum, iki komponent saplı  
Chrom vanadium, Two component handle

KOD CODE	mm	L mm	g	TL/Ad.
13000 005610	2.5	84	15	5 249,25
13000 005611	3	98	20	5 253,25
13000 005612	4	106	35	5 284,75
13000 005613	5	120	55	5 304,00
13000 005614	6	134	80	5 346,50
13000 005615	7	145	105	5 364,00
13000 005616	8	145	145	5 427,00
13000 005617	10	170	225	5 663,50

### 13000 008092

### 1000V İzoleli T Tipi Allen Anahtar Takımı (8 Parça, mm) Hex Key Wrench T - Handle Set Insulated 1000V (8 Pcs, mm)

**YENİ TASARIM  
NEW DESIGN**



KOD CODE	İÇERİK CONTENTS	g	TL/Ad.
13000 008092	2.5 - 3 - 4 - 5 6 - 7 - 8 - 10	695	8 2.891,00

# BİTS UÇLAR ve APARATLARI

BITS & BITS ACCESSORIES

- Bits Tutucular  
Bits Holders
- Bits Uçlar ve Aparatları  
Bits & Bits Accessories



4780 19 6120

Manyetik Bits Tutucu Tornavida (Uzun)  
Screwdriver, Magnetic Bit Holder (Long)



KOD CODE	mm	L mm	L1 mm	g	TL/Ad.
4780 19 6120	6.3	230	120	105	10 498,25

4783 19 6120

1000V Süngüsü İzoleli Manyetik Bits Tutucu Tornavida  
Screwdriver, Magnetic Bit Holder Insulated 1000V

△ 1000 V  
IEC 60900

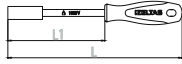

KOD CODE	mm	L mm	L1 mm	g	TL/Ad.
4783 19 6120	6.3	230	120	120	10 617,25

4785 19 6330

Manyetik Bits Tutucu Tornavida (Kısa)  
Screwdriver, Magnetic Bit Holder (Short)

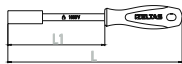

KOD CODE	mm	L mm	L1 mm	g	TL/Ad.
4785 19 6330	6.3	130	30	55	10 272,50

4795 19 0010

T Tipi Manyetik Bits Tutucu Tornavida  
Magnetic Bit Holder With T-Handle

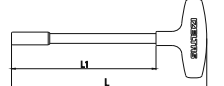

KOD CODE	mm	L mm	L1 mm	g	TL/Ad.
4795 19 0010	6.3	180	130	85	10 528,25

4788 19 6160

Manyetik Bits Tutucu Tornavida, Flexible  
Screwdriver, Magnetic Bit Holder, Flexible

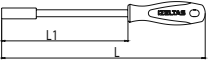

KOD CODE	mm	L mm	L1 mm	g	TL/Ad.
4788 19 6160	6.3	285	175	140	10 1.033,00

4815 00 6107

Değişken Bits Uçlu Tornavida Set (7 parça)  
Screwdriver - Interchangeable Bits Set (7 pcs)



KOD CODE	İÇERİK CONTENTS	g	TL/Ad.
4815 00 6107	100mm Sap - Handle Ph1x4.5 - Ph2x5.5 - Ph3x7 Pz1x4.5 - Pz2x5.5 - Pz3x7	135	7 573,50

13000 005429

### Cırcırlı Manyetik Bits Uç Tutucu Tornavida Seti (8 Parça) Multi Bit Ratcheting Screwdriver Set (8 Pcs)



KOD CODE	İÇERİK CONTENTS	g		TL/Ad.
	6'lı Bits Set Bit Set (6 Pcs) 0.6x4.5 - 0.8x5.5 Ph1 - Ph2 - Ph3 T27	230	6	1.073,25
13000 005278	Cırcırlı Manyetik Bits Tutucu Tornavida (175mm) Ratcheting Screwdriver (175mm)		1	
4790 26 6360	Üniversal Bits Adaptörü (Manyetik) Screwdriver Universal Bit Holder (Magnetic)		1	

13000 005278

### Cırcırlı Manyetik Bits Uç Tutucu Tornavida Ratcheting Screwdriver



KOD CODE	mm	L mm	g		TL/Ad.
13000 005278	6.3	175	145	5	632,25

4790 26 6360

Üniversal Bits Adaptörü (Manyetik)  
Screwdriver Universal Bit Holder (Magnetic)



KOD CODE	mm	mm	L mm	g		TL/ Ad.
4790 26 6360	6.3	6.3	60	20	10	238,50

4805 20 5010

Bits Uç Lokma Adaptörü (Makine Kullanımına Uygun)  
Socket Adapter



KOD CODE	mm	L mm	g		TL/ Ad.
4805 20 5010	1/4" M - 1/4" M	50	15	10	86,50

4800 00 8106

6'lı Bits Uç Set  
Bit Set (6 Pcs)



KOD CODE	İÇERİK CONTENTS	g		TL/ Ad.
4800 00 8106	0.6x4.5 - 0.8x5.5	30	6	202,50
	Ph1 - Ph2 - Ph3			
	T27			

4800 00 8110

10'lu Bits Uç Set  
Bit Set (10 Pcs)



KOD CODE	İÇERİK CONTENTS	g		TL/ Ad.
4800 00 8110	0.6x4.5 - 0.8x5.5 1.2x6.5	50	10	373,00
	Ph1 - Ph2 - Ph3			
	T25 - T27 - T30 - T40			

4800 00 8131

31'li Bits Uç Set (Plastik Kutulu)  
Bit Set In Plastic Case (31 Pcs)

YENİ TASARIM  
NEW DESIGN



KOD CODE	İÇERİK CONTENTS	g		TL/ Ad.
4800 00 8131	0.6x4.5 - 0.8x5.5	240	6 - 6	1.251,00
	1.2x6.5			
	Ph1			
	Ph2 - Ph3			
	T27			
	T25 - T30 - T40 6.3 x 60 Adaptör			

**4810-4860**
**Düz Bits Uçlar**
**Bits Flat**

25mm-50mm-75mm-100mm-150mm



KOD CODE	⊖		L mm	g	□	TL/Ad.
	a mm	b mm				
4810 20 0645	0.6	4.5	25	5	10	30,25
4810 20 0855	0.8	5.5	25	5	10	30,25
4810 20 1265	1.2	6.5	25	5	10	30,25
4810 20 5645	0.6	4.5	50	10	10	48,00
4810 20 5855	0.8	5.5	50	10	10	48,00
4810 20 5265	1.2	6.5	50	10	10	48,00
4860 20 0745	0.6	4.5	75	15	10	72,75
4860 20 0755	0.8	5.5	75	15	10	72,75
4860 20 0765	1.2	6.5	75	20	10	72,75
4860 20 1045	0.6	4.5	100	15	10	108,50
4860 20 1055	0.8	5.5	100	20	10	108,50
4860 20 1065	1.2	6.5	100	25	10	108,50
4860 20 1545	0.6	4.5	150	20	10	153,50
4860 20 1555	0.8	5.5	150	30	10	153,50
4860 20 1565	1.2	6.5	150	40	10	153,50

**4820-4870**
**Yıldız Bits Uçlar**
**Bits Phillips**

25mm-50mm-75mm-100mm-150mm



KOD CODE	⊕	L mm	g	□	TL/Ad.
4820 21 0002	Ph2	25	5	10	31,75
4820 21 0003	Ph3	25	5	10	31,75
4820 21 0011	Ph1	50	10	10	56,25
4820 21 0012	Ph2	50	10	10	56,25
4820 21 0013	Ph3	50	10	10	56,25
4870 21 0701	Ph1	75	15	10	75,25
4870 21 0702	Ph2	75	15	10	75,25
4870 21 0703	Ph3	75	15	10	75,25
4870 21 1001	Ph1	100	20	10	115,25
4870 21 1002	Ph2	100	20	10	115,25
4870 21 1003	Ph3	100	20	10	115,25
4870 21 1501	Ph1	150	25	10	161,75
4870 21 1502	Ph2	150	30	10	161,75
4870 21 1503	Ph3	150	30	10	161,75

**4810**
**Düz Bits Uç Takımı (10 Parça, 25 mm)**

Flat Bit Set (10 Pcs, 25 mm)



KOD CODE	⊖	g	□	TL/Ad.
4810 00 0645	0.6x4.5	45	10	302,50
4810 00 0855	0.8x5.5	50	10	302,50
4810 00 1265	1.2x6.5	55	10	302,50

**4820**
**Yıldız Bits Uç Takımı (10 Parça, 25 mm)**

Phillips Bit Set (10 Pcs, 25 mm)



KOD CODE	⊕	g	□	TL/Ad.
4820 00 0001	Ph1	50	10	317,50
4820 00 0002	Ph2	50	10	317,50
4820 00 0003	Ph3	55	10	317,50

## 4825-4880

### Pozidriv Bits Uçlar

Bits Pozidriv

25mm-50mm-75mm-100mm-150mm



KOD CODE	+	L mm	g	□	TL/Ad.
4825 21 0001	Pz1	25	5	10	34,25
4825 21 0002	Pz2	25	5	10	34,25
4825 21 0003	Pz3	25	5	10	34,25
4825 21 0011	Pz1	50	10	10	60,50
4825 21 0012	Pz2	50	10	10	60,50
4825 21 0013	Pz3	50	10	10	60,50
4880 21 0701	Pz1	75	15	10	76,75
4880 21 0702	Pz2	75	15	10	76,75
4880 21 0703	Pz3	75	15	10	76,75
4880 21 1001	Pz1	100	15	10	116,50
4880 21 1002	Pz2	100	15	10	116,50
4880 21 1003	Pz3	100	20	10	116,50
4880 21 1501	Pz1	150	25	10	165,75
4880 21 1502	Pz2	150	30	10	165,75
4880 21 1503	Pz3	150	35	10	165,75

## 4825

### Pozidriv Bits Uç Takımı (10 Parça, 25 mm)

Pozidriv Bit Set (10 Pcs, 25 mm)



KOD CODE	+	g	□	TL/Ad.
4825 00 0001	Pz1	45	10	342,50
4825 00 0002	Pz2	50	10	342,50
4825 00 0003	Pz3	55	10	342,50

## 4830-4885

### Torx® Bits Uçlar

Bits Torx®

25mm-50mm-75mm-100mm-150mm



KOD CODE	+	L mm	g	□	TL/Ad.
4830 21 0025	T25	25	5	10	46,75
4830 21 0027	T27	25	5	10	46,75
4830 21 0030	T30	25	5	10	46,75
4830 21 0040	T40	25	5	10	46,75
4830 21 0125	T25	50	10	10	60,50
4830 21 0127	T27	50	10	10	60,50
4830 21 0130	T30	50	10	10	60,50
4830 21 0140	T40	50	10	10	60,50
4885 21 0725	T25	75	15	10	82,25
4885 21 0727	T27	75	15	10	82,25
4885 21 0730	T30	75	15	10	82,25
4885 21 0740	T40	75	20	10	82,25
4885 21 1025	T25	100	15	10	117,75
4885 21 1027	T27	100	20	10	117,75
4885 21 1030	T30	100	20	10	117,75
4885 21 1040	T40	100	25	10	117,75
4885 21 1525	T25	150	25	10	168,50
4885 21 1527	T27	150	30	10	168,50
4885 21 1530	T30	150	30	10	168,50
4885 21 1540	T40	150	40	10	168,50

## 4830

### Torx® Bits Uç Takımı (10 Parça, 25 mm)

Torx® Bit Set (10 Pcs, 25 mm)



KOD CODE	+	g	□	TL/Ad.
4830 00 0025	T25	50	10	467,50
4830 00 0027	T27	50	10	467,50
4830 00 0030	T30	55	10	467,50
4830 00 0040	T40	60	10	467,50

**4784 19 6346**
**1/4"Avuç İçi Bits Uç Tutucu**  
 Palm Ratchet Bit Holder

KOD CODE	ø	L mm	g		TL/Ad.
4784 19 6346	46	26,5	85	5	960,50

**4850 00 1013**
**100mm Uzun Bits Uç Takımı (13 Parça)**  
 Bit Set, Long Type 100 mm (13 Pcs)

**100mm**

KOD CODE	İÇERİK CONTENTS	g		TL/Ad.
4850 00 1013	Düz Uçlar Flat Bits 0.6x4.5 - 0.8x 5.5 1.2x6.5	280	13	1.491,75
	Yıldız Uçlar Phillips Bits Ph1 - Ph2 - Ph3			
	Pozidriv Uçlar Pozidriv Bits Pz1 - Pz2 - Pz3			
	Torx® Uçlar Torx® Bits T25 - T27 - T30 - T40			

**4850 00 0713**
**75mm Uzun Bits Uç Takımı (13 Parça)**  
 Bit Set, Long Type 75 mm (13 Pcs)

**75mm**

KOD CODE	İÇERİK CONTENTS	g		TL/Ad.
4850 00 0713	Düz Uçlar Flat Bits 0.6x4.5 - 0.8x 5.5 1.2x6.5	205	13	1.003,25
	Yıldız Uçlar Phillips Bits Ph1 - Ph2 - Ph3			
	Pozidriv Uçlar Pozidriv Bits Pz1 - Pz2 - Pz3			
	Torx® Uçlar Torx® Bits T25 - T27 T30 - T40			

**4850 00 1513**
**150mm Uzun Bits Uç Takımı (13 Parça)**  
 Bit Set, Long Type 150 mm (13 Pcs)

**150mm**

KOD CODE	İÇERİK CONTENTS	g		TL/Ad.
4850 00 1513	Düz Uçlar Flat Bits 0.6x4.5 - 0.8x 5.5 1.2x6.5	280	13	2.117,00
	Yıldız Uçlar Phillips Bits Ph1 - Ph2 - Ph3			
	Pozidriv Uçlar Pozidriv Bits Pz1 - Pz2 - Pz3			
	Torx® Uçlar Torx® Bits T25 - T27 - T30 - T40			

### Darbeli Yıldız Bits Uçlar Impact Bits Phillips 25mm-50mm-75mm

YENİ  
NEW

1/4"

Yüksek alaşımlı çelik  
High alloy steel

KOD CODE	+	L mm	g	□	TL/Ad.
14000 005904	Ph1	25	4	10	34,75
14000 005905	Ph2	25	5	10	34,75
14000 005906	Ph3	25	5	10	34,75
14000 005920	Ph1	50	4	10	49,75
14000 005921	Ph2	50	5	10	49,75
14000 005922	Ph3	50	5	10	49,75
14000 005886	Ph1	75	13	10	64,25
14000 005887	Ph2	75	15	10	64,25
14000 005888	Ph3	75	16	10	64,25

### Darbeli Pozidriv Bits Uçlar Impact Bits Pozidriv 25mm-50mm-75mm

YENİ  
NEW

1/4"

Yüksek alaşımlı çelik  
High alloy steel

KOD CODE	+	L mm	g	□	TL/Ad.
14000 005901	Pz1	25	4	10	34,75
14000 005902	Pz2	25	5	10	34,75
14000 005903	Pz3	25	5	10	34,75
14000 005917	Pz1	50	8	10	49,75
14000 005918	Pz2	50	9	10	49,75
14000 005919	Pz3	50	10	10	49,75
14000 005883	Pz1	75	13	10	64,25
14000 005884	Pz2	75	15	10	64,25
14000 005885	Pz3	75	16	10	64,25

### Darbeli Torx® Bits Uçlar Impact Bits Torx® 25mm-50mm-75mm

YENİ  
NEW

1/4"

Yüksek alaşımlı çelik  
High alloy steel

KOD CODE	+	L mm	g	□	TL/Ad.
14000 005907	T10	25	3	10	34,75
14000 005908	T20	25	4	10	34,75
14000 005909	T30	25	5	10	34,75
14000 005910	T40	25	6	10	34,75
14000 005923	T10	50	7	10	49,75
14000 005924	T20	50	8	10	49,75
14000 005925	T30	50	9	10	49,75
14000 005926	T40	50	10	10	49,75
14000 005889	T10	75	11	10	64,25
14000 005890	T20	75	13	10	64,25
14000 005891	T30	75	16	10	64,25
14000 005892	T40	75	18	10	64,25

### Darbeli Allen Bits Uçlar Impact Bits Hex Key 25mm-50mm-75mm-89mm

YENİ  
NEW

1/4"

Yüksek alaşımlı çelik  
High alloy steel

KOD CODE	+	L mm	g	□	TL/Ad.
14000 005911	H2	25	3	10	34,75
14000 005912	H3	25	3	10	34,75
14000 005913	H4	25	4	10	34,75
14000 005914	H5	25	5	10	34,75
14000 005915	H6	25	6	10	34,75
14000 005916	H7	25	7	10	34,75
14000 005927	H2	50	6	10	49,75
14000 005928	H3	50	7	10	49,75
14000 005929	H4	50	8	10	49,75
14000 005930	H5	50	9	10	49,75
14000 005931	H6	50	10	10	49,75
14000 005932	H7	50	13	10	49,75
14000 005933	H8	50	13	10	42,25
14000 005978	H10	50	19	10	48,25
14000 005893	H2	75	10	10	64,25
14000 005894	H3	75	11	10	64,25
14000 005895	H4	75	14	10	64,25
14000 005896	H5	75	17	10	64,25
14000 005897	H6	75	20	10	64,25
14000 005898	H7	75	23	10	64,25
14000 005899	H8	89	20	10	59,75
14000 005900	H10	89	30	10	59,75

# KESKİLER VE ÇEKİÇLER

CHISELS AND HAMMERS

- Keskiiler  
Chisels
- Zimbalar  
Punches
- Çekiçler  
Hammers
- Balta ve Nacaklar  
Hatchets
- Keserler  
Adzes



## EMNİYET ÇEKİCİ / SAFETY HAMMER



İZELTAS USTA İŞİ  
SOHBETLER

**5010**
**Iskarpela (Düz)**  
**Wood Chisel**

TS 531

**YENİ TASARIM**  
**NEW DESIGN**

**Özel alaşımli çelik, Uç indüksiyonda sertleştirilmiş, PP Saplı**  
**Special steel, Induction hardened tips, PP Handle**

KOD CODE	a mm	L mm	L1 mm	g	TL/Ad.	
5010 23 0006	6	245	120	140	5	417,25
5010 23 0008	8	247	122	150	5	444,75
5010 23 0010	10	249	124	155	5	469,50
5010 23 0012	12	251	126	160	5	516,00
5010 23 0014	14	253	128	165	5	532,50
5010 23 0016	16	255	130	180	5	570,75
5010 23 0018	18	257	132	180	5	618,50
5010 23 0020	20	259	134	195	5	687,00
5010 23 0022	22	261	136	220	5	744,50
5010 23 0024	24	263	138	200	5	804,75
5010 23 0026	26	265	140	230	5	833,50
5010 23 0030	30	269	144	255	5	889,25

**5010 00 8106**
**Iskarpela Düz Takım (6 parça)**  
**Wood Chisel Set (6 Pcs)**
**YENİ TASARIM**  
**NEW DESIGN**

KOD CODE	İÇERİK CONTENTS	g	TL/Ad.	
5010 00 8106	10 - 12 - 14 16 - 18 - 20	1200	6	3.394,25

**5500**
**Düz Keski**  
**Flat Cold Chisel**



 TS 492  
 DIN 6453

**Özel alaşımli çelik, Krom kaplı**  
**Special steel, Chrom plated**

KOD CODE	L mm	a mm	g	TL/Ad.	
5500 23 0100	100	17	70	5	250,75
5500 23 0125	125	19	110	5	301,00
5500 23 0150	150	21	170	5	386,00
5500 23 0175	175	24	245	5	435,25
5500 23 0200	200	27	340	5	605,00
5500 23 0250	250	30	520	5	743,00
5500 23 0300	300	30	635	5	1.190,25

**5500**
**Düz Keski (Kalkan İzoleli)**  
**Flat Cold Chisel (With Safety Handle)**

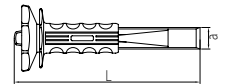

 TS 492  
 DIN 6453

**Özel alaşımli çelik, Krom kaplı, PVC İzoleli**  
**Special steel, Chrom plated, PVC Handle**

KOD CODE	L mm	a mm	g	TL/Ad.	
5500 23 1250	250	30	720	1	945,50
5500 23 1300	300	30	920	1	1.377,75

5510

### Tesviyeci Düz Keski

#### Flat Cold Chisel Octagonal

TS 492  
DIN 6453

Krom vanadyum, Fosfat kaplı  
Chrom vanadium, Phosphate finish

KOD CODE	L mm	a mm	g	TL/Ad.
5510 23 0125	125	10	65	342,00
5510 23 0150	150	14	140	427,00

5520

### Tırnak Keski

#### Cross Cut Chisel



Krom vanadyum, Fosfat kaplı  
Chrom vanadium, Phosphate finish

KOD CODE	L mm	a mm	g	TL/Ad.
5520 23 0125	130	5	65	383,25
5520 23 0150	150	6	130	457,25

5540

### Nokta Zimba

#### Center Punch

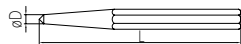
TS 2338-3  
DIN 7250

Krom vanadyum, Fosfat kaplı  
Chrom vanadium, Phosphate finish

KOD CODE	L mm	L inch	σD mm	g	TL/Ad.
5540 24 4120	120	4 3/4"	4	55	288,75
5540 24 5120	120	4 3/4"	5	100	341,00
5540 24 5150	150	6"	5	130	376,25

5545

### Konik Pim Zimba

#### Drift Punch

TS 2338-2  
DIN 6458

Krom vanadyum, Fosfat kaplı  
Chrom vanadium, Phosphate finish

KOD CODE	L mm	L inch	σD mm	g	TL/Ad.
5545 24 0002	120	4 3/4"	2	100	249,25
5545 24 0003	120	4 3/4"	3	100	271,25
5545 24 0004	120	4 3/4"	4	100	305,25
5545 24 0005	120	4 3/4"	5	100	310,75
5545 24 0006	120	4 3/4"	6	105	457,25
5545 24 0007	120	4 3/4"	7	110	476,25
5545 24 0008	150	6"	8	140	494,00
5545 24 0009	150	6"	9	140	506,25
5545 24 0010	150	6"	10	145	516,00
★ 5545 24 0012	150	6"	12	225	540,50

5550

### Düz Pim Zimba

#### Split Pin Punch

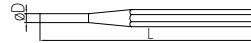
TS 2338-1  
DIN 6450

Krom vanadyum, Fosfat kaplı  
Chrom vanadium, Phosphate finish

KOD CODE	L mm	L inch	σD mm	g	TL/Ad.
5550 24 0002	150	6"	2	65	357,25
5550 24 0003	150	6"	3	60	357,25
5550 24 0004	150	6"	4	60	362,75
5550 24 0005	150	6"	5	60	362,75
5550 24 0006	150	6"	6	65	365,50
5550 24 0007	150	6"	7	110	380,50
5550 24 0008	150	6"	8	115	406,50
5550 24 0009	150	6"	9	1120	413,25
5550 24 0010	150	6"	10	130	417,25

5550 00 1006

### Düz Pim Zimba Takımı (6 Parça)

#### Split Pin Punch (6 Pcs)



KOD CODE	İÇERİK CONTENTS	g	TL/Ad.
5550 00 1006	3 - 4 - 5 - 6 - 7 - 8	550	6 2.235,25

★ Stoklarla Sınırlıdır / It is Limited by Stocks.

**5600 00 6106**
**Keski Zımba Seti (6 Parça)**  
 Chisel And Punch Set (6 Pcs)

KOD CODE	İÇERİK CONTENTS	g	TL/Ad.
5510 23 0125	125 Tevsiyecı Düz Keski 125 Flat Cold Chisel Octagonal	1	2.075,00
5510 23 0150	150 Tevsiyecı Düz Keski 150 Flat Cold Chisel Octagonal	1	
5520 23 0125	130 Tırnak Keski 130 Cross Cut Chisel	1	
5540 24 4120	4x120 Nokta Zımba 4x120 Center Punch	1	
5550 24 0005	5x150 Düz Pim Zımba 5x150 Split PinPunch	1	
5545 24 0003	3x120 Konik Pim Zımba 3x120 Drift Punch	1	

**5700**
**Kayış Zımba**  
 Belt Punch

DIN 7200

 Krom vanadyum, Elektrostatik boyanmış  
 Chrom vanadium, Electrostatically painted

KOD CODE	ØD mm	L mm	g	TL/Ad.
5700 24 0003	3	105	35	213,50
5700 24 0004	4	105	40	223,25
5700 24 0005	5	110	50	242,25
5700 24 0006	6	110	55	247,75
5700 24 0007	7	115	75	272,50
5700 24 0008	8	115	100	288,75
5700 24 0009	9	120	100	323,00
5700 24 0010	10	120	110	343,50
5700 24 0011	11	125	145	369,50
5700 24 0012	12	125	135	442,25
5700 24 0013	13	130	165	465,25
5700 24 0014	14	130	215	510,50
5700 24 0015	15	135	245	584,25
5700 24 0016	16	135	300	640,50
5700 24 0017	17	140	340	700,75
5700 24 0018	18	140	365	763,75
5700 24 0019	19	145	410	830,50
5700 24 0020	20	145	440	884,00

**5700**
**Kayış Zımba Takımı**  
 Belt Punch Set



KOD CODE	İÇERİK CONTENTS	g	TL/Ad.
5700 00 2110	3 - 4 - 5 - 6 - 7 8 - 9 - 10 - 11 - 12	815	2.966,25
5700 00 2112	3 - 4 - 5 - 6 - 7 - 8 - 9 10 - 11 - 12 - 13 - 14	1245	3.942,00

5800

### Tesviyeci Çekiç Machinist Hammer

TS 5-1  
DIN 1041

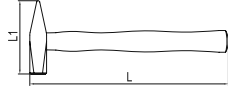
IZELTAS YOUTUBE



 Yedek parça sayfa 255-259  
Spare parts page 255-259

Özel alaşımli çelik, İndüksiyonda sertleştirilmiş, Elektrostatik boyanmış  
Special steel, Induction hardened, Electrostatically painted

KOD CODE	L mm	L1 mm	g	g	TL/Ad.
5800 25 0100	260	82	100	145	10 483,00
5800 25 0200	280	95	200	260	10 527,25
5800 25 0300	300	105	300	385	10 638,50
5800 25 0500	320	118	500	610	5 738,50
5800 25 1000	360	135	1000	1100	5 1.067,00
5800 25 1500	380	145	1500	1680	5 1.399,50
5800 25 2000	400	155	2000	2180	5 1.720,75

5810

### Emniyet Çekici Safety Hammer

TS 5-1

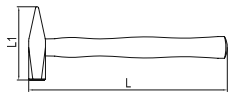

Özel alaşımli çelik, İndüksiyonda sertleştirilmiş, Elektrostatik boyanmış  
Special steel, Induction hardened, Electrostatically painted

KOD CODE	L mm	L1 mm	g	g	TL/Ad.
5810 25 1000	360	135	1000	1145	5 1.331,25
5810 25 1500	380	145	1500	1650	5 1.841,50
5810 25 2000	400	155	2000	2185	5 2.273,75

### Emniyet çekici

Çekiç kafası ile sapın birleşiminde yuvarlak kama ve yapışkan malzeme kullanılarak sağlamlığı artırılmış ayrıca birleşimi çelik sac malzeme ile desteklenerek güvenli kullanım sağlanmıştır.

### Safety Hammer

Connection between the hammer head and the handle is ensured by circular wedge and epoxy glue, while it is also reinforced by sheet metal for safe use.

### Fiber Saplı Çekiç Fiber Handle Hammer

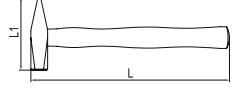
TS 5-1  
DIN 1041

Özel alaşımli çelik, İndüksiyonda sertleştirilmiş  
Special steel, Induction hardened

KOD CODE	L mm	L1 mm	g	TL/Ad.
14000 005215	320	118	745	1 1.435,75
14000 005216	360	135	1300	1 2.354,75
14000 005217	390	145	2110	1 3.148,25
14000 005218	400	155	2400	1 3.877,25

5850

### Plastik Çekiç Plastic Hammer



TS 5-2

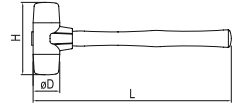

 Yedek parça sayfa 255-259  
Spare parts page 255-259

Darbeye dayanıklı,  
Kolay değiştirilebilir başlık  
Durable and easily changeable heads

KOD CODE	L mm	σD mm	H mm	g	TL/Ad.
5850 25 0030	300	30	100	350	5 691,50
5850 25 0040	320	40	110	640	5 840,00
5850 25 0050	350	50	120	990	5 1.065,50

5870 25 0400

### Lastik Çekiç Rubber Hammer

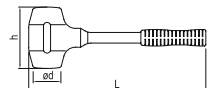

KOD CODE	L mm	σd mm	h mm	g	g	TL/Ad.
5870 25 0400	300	47	104	400	550	5 1.280,75

5865

 Madırğa  
Mallet

TS 5-1

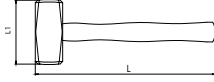

Yedek parça sayfa 255-259  
Spare parts page 255-259

 Özel alaşımli çelik  
Special steel

KOD CODE	L mm	L1 mm				TL/Ad.
5865 25 1000	260	95	1000	1210	5	1.220,50
5865 25 1500	280	110	1500	1770	5	1.457,00

6410 25 0800

 Nacak  
Hatchet

TS 748-4

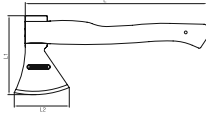

Yedek parça sayfa 255-259  
Spare parts page 255-259

 Özel alaşımli çelik, İndüksiyonda sertleştirilmiş, Elektostatik boyanmış  
Special steel, Induction hardened, Electrostatically painted

KOD CODE	L mm	L1 mm	L2 mm				TL/Ad.
6410 25 0800	380	165	115	800	1145	1	2.435,25

13000 005248

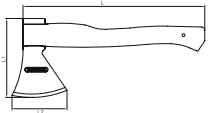
 Kamp Baltası  
Camping Hatchet

 Özel alaşımli çelik, Elektostatik boyanmış  
Special steel, Electrostatically painted

KOD CODE	L mm	L1 mm	L2 mm			TL/Ad.
13000 005248	270	118	85	645	1	2.014,00

6400 25 0600

 Keser  
Adze

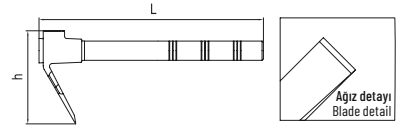
TS 686-2



Yedek parça sayfa 255-259  
Spare parts page 255-259

 Özel alaşımli çelik, İndüksiyonda sertleştirilmiş,  
Elektostatik boyanmış, PVC ağız koruyucu  
Special steel, Induction hardened, Electrostatically painted,  
PVC cutting edge protector

KOD CODE	L mm	h mm				TL/Ad.
6400 25 0600	400	125	400	600	5	1.404,00

6401 25 0600

 Usta Keseri  
Master Adze

TS 686-2

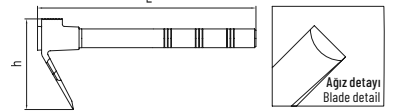

Yedek parça sayfa 255-259  
Spare parts page 255-259

 Özel alaşımli çelik, İndüksiyonda sertleştirilmiş,  
Elektostatik boyanmış, PVC ağız koruyucu  
Special steel, Induction hardened, Electrostatically painted,  
PVC cutting edge protector

KOD CODE	L mm	h mm				TL/Ad.
6401 25 0600	400	125	400	600	5	1.404,00



# GENEL EL ALETLERİ

## GENERAL HAND TOOLS

- Kablo Sıyırıcılar  
Cable Stripper
- Metreler  
Measuring Tapes
- Su Terazisi  
Straight Level
- Testereler  
Saws
- Servis Aletleri  
Service Equipment
- Gres Pompası ve Yağdanlık  
Grease Gun and Oilers
- Yağ Filtre Sökecekleri  
Oil Filter Wrench
- Tel Fırçalar  
Hand Brushes
- Uzatma Kabloları  
Extension Cords
- Multi Tool  
Multi Tool
- Mengeneler  
Forged Steel Vice
- İşkenceler  
Clamps
- Spreyler  
Spreys



14000 005269

180 mm Multi Tool Pro (15 Fonksiyonlu)

180 mm Multi Tool Pro (15 Functions)

# MULTI TOOL PRO

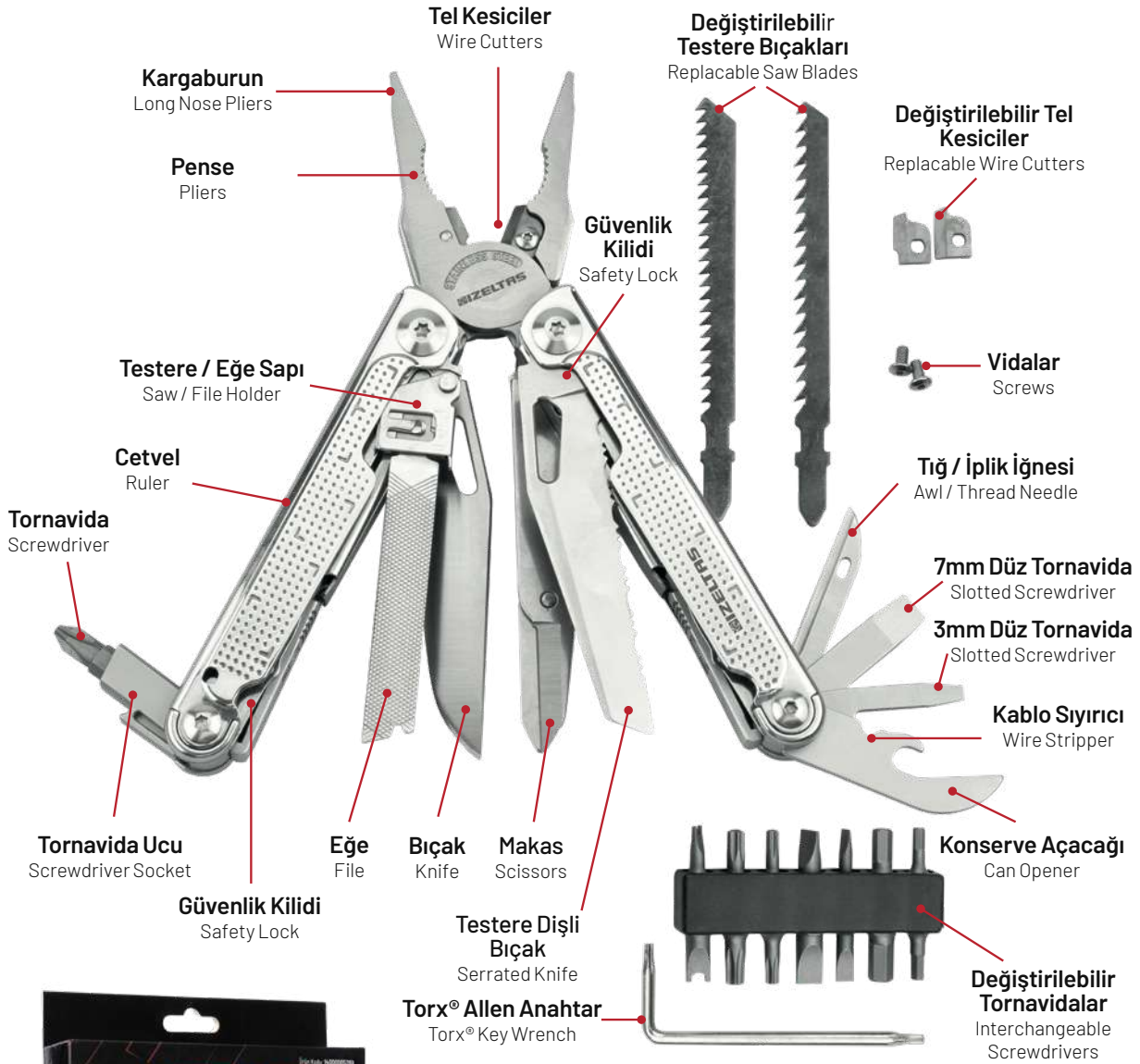

İZELTAS YOUTUBE



KOD CODE	L mm	g	1	TL/Ad.
14000 005269	180	720	1	4.288,00

Özel hediye kutusuyla satılır / Sold with a special gift box

14000 005270

155 mm Multi Tool (15 Fonksiyonlu)

155 mm Multi Tool (15 Functions)

**MULTI  
TOOL**

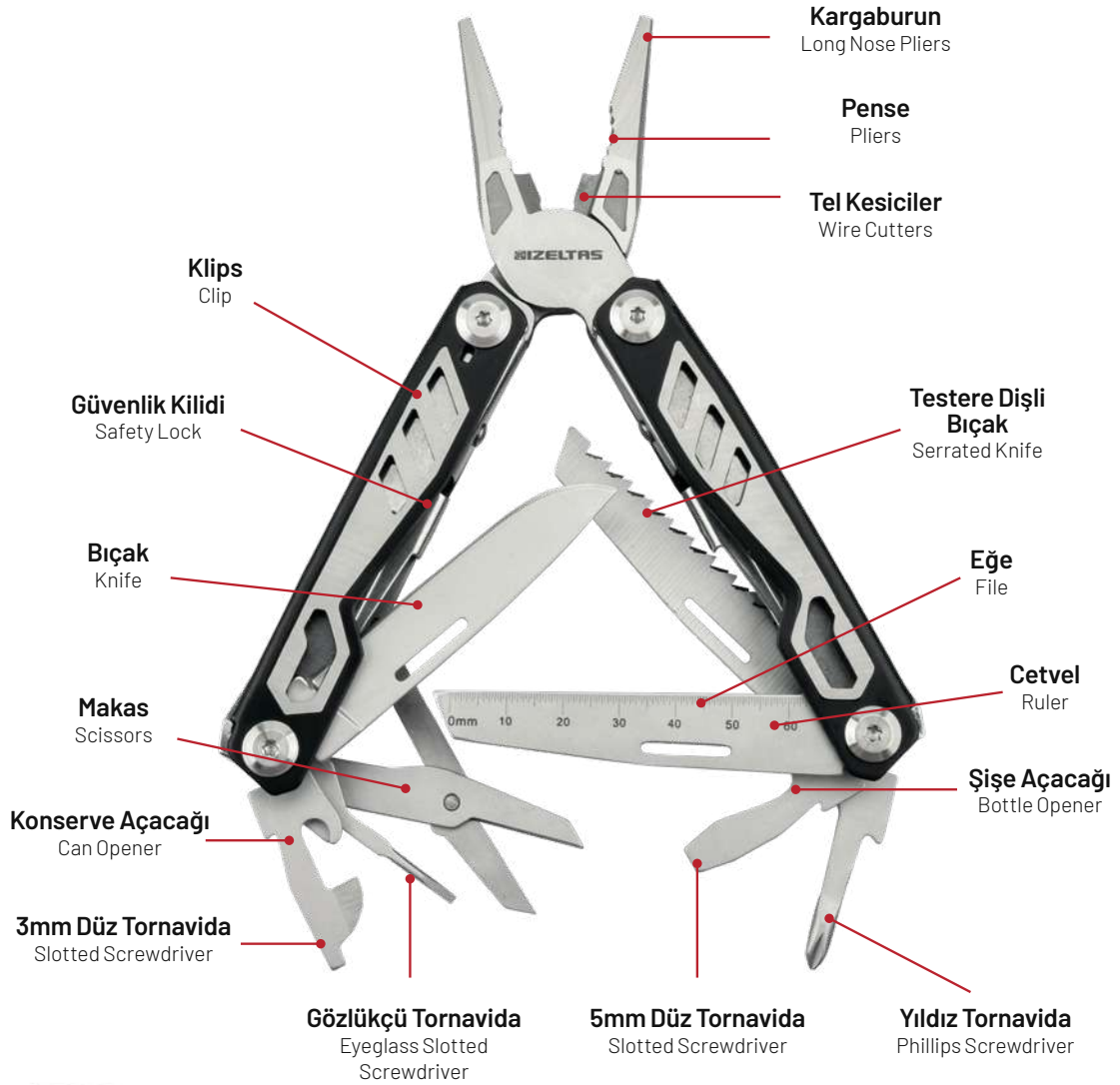

İZELTAS YOUTUBE



KOD CODE	L mm	g	1	TL/Ad.
14000 005270	155	540	1	1.868,75

Özel hediye kutusuyla satılır / Sold with a special gift box

**KABLO SIYIRICI (KANCA BIÇAKLI) / CABLE STRIPPER (WITH HOOKED BLADE)**

Tüm standart kabloları sıyırmak için daha uzun ömür, daha hızlı kesme ve daha az aşınma sağlayan özel titanyum nitrür (TIN) kaplama  
Tin plated long lasting/fast cutting blade to strip all

Özel alışımlı çelikten sertleştirilmiş ve kaplanmış kanca bıçak  
Plated special alloy hardened steel hook blade

Kapasite 8-28mm çaplı kablolar için uygun  
Suitable for 8-28mm diameter cables

Özel kaydırmaz formu dayanıklı polyamid (PA) sap  
Non-slip and durable polyamid handle

Çevirerek kolay bıçak yükseklik ayarı  
Easy-to-rotate blade height adjuster

**03750 50 020**
**Kablo Sıyırıcı (Kanca Bıçaklı)**  
 Cable Stripper (With Hooked Blade)

 Yedek parça sayfa 255-259  
 Spare parts page 255-259

KOD CODE	ÖLÇÜ SIZE	g	TL/Ad.
03750 50 020	Ø8-28	80	925,00

**03752 50 625**
**Kablo Sıyırıcı**  
 Cable Stripper

 Yedek parça sayfa 255-259  
 Spare parts page 255-259

İZELTAS YOUTUBE

KOD CODE	ÖLÇÜ SIZE	g	TL/Ad.
03752 50 625	Ø4-16	70	842,75

**03751 50 012**
**Koaksiyel Kablo Sıyırıcı**  
 Coaxial Cable Stripper

İZELTAS YOUTUBE

KOD CODE	ÖLÇÜ SIZE	g	TL/Ad.
03751 50 012	A Dış (1) B İç (2)	20	1.200,00

**03753 50 054**
**Mekanik Kablo Sıyırıcı**  
 Mechanical Cable Stripper

KOD CODE	ÖLÇÜ SIZE	g	TL/Ad.
03753 50 054	0.2/6	105	1.581,50

**03753 50 026**
**Elektro Mekanik Kablo Sıyırıcı**  
 Mechanical Cable Stripper

KOD CODE	ÖLÇÜ SIZE	g	TL/Ad.
03753 50 026	0.2/6	110	1.974,25

05881

Plastik Şerit Metre (3m - 5m)  
Plastic Steel Case, Measuring Tapes



KOD CODE	ÖLÇÜ SIZE M	g		TL/Ad.
0588150 003	3	155	5	375,25
0588150 005	5	200	5	450,50

05881

Krom Şerit Metre (3m - 5m)  
Chrom Steel Case, Measuring Tapes



Şeridin her iki yüzeyi de ölçü skalalıdır / Both sides of the tape has measurements

KOD CODE	ÖLÇÜ SIZE M	g		TL/Ad.
05881 50 013	3	175	5	446,25
05881 50 015	5	210	5	503,75

14000 005371

Krom Şerit Metre (8m)  
Chrom Steel Case, Measuring Tapes



Şeridin her iki yüzeyi de ölçü skalalıdır / Both sides of the tape has measurements

KOD CODE	ÖLÇÜ SIZE M	g		TL/Ad.
14000 005371	8	410	5	795,25

05886

Arazi Tipi Fiberglas Şerit Metre (Saplı)  
Fiberglass Measuring Tape Field Type (With Holder)

YENİ TASARIM  
NEW DESIGN

KOD CODE	ÖLÇÜ SIZE M	g		TL/Ad.
05886 50 020	20	515	1	901,75
05886 50 030	30	605	1	963,50
05886 50 050	50	850	1	1.547,50

05887 50 150

Kumpas  
Vernier

Sürgülü, Stoplu  
Sliding and with stop

KOD CODE	L mm	g		TL/Ad.
05887 50 150	150	175	5	3.246,50

05880

Su Terazisi  
Straight Level

YENİ TASARIM  
NEW DESIGNAlüminyum gövde  
Aluminyum body

KOD CODE	L mm	g		TL/Ad.
05880 50 040	400	245	5	1.346,50
05880 50 050	500	300	5	1.458,50
05880 50 060	600	360	5	1.585,75
05880 50 070	700	415	5	1.703,25
05880 50 080	800	460	5	1.840,00
05880 50 100	1000	560	5	2.094,50
05880 50 120	1200	665	5	2.477,75
05880 50 150	1500	795	5	2.855,25
05880 50 200	2000	1555	5	3.987,75

**05901 50 020**
**Sentil (20 Parça, mm)**  
 Feeler Gauges (20 Pcs, mm)

KOD CODE	ÖLÇÜ SIZE mm	g		TL/ Ad.
05901 50 020	0.05 - 1	90	10	298,50

**05902 50 020**
**Sentil (20 Parça, SAE)**  
 Feeler Gauges (20 Pcs, SAE)

KOD CODE	ÖLÇÜ SIZE inch	g		TL/ Ad.
05902 50 020	2 - 35/1000"	95	10	465,25

**6735 27 0300**
**Dal Budama Testeresi**  
 Pruning Saw

 Yedek parça sayfa 255-259  
 Spare parts page 255-259

KOD CODE	L mm	g		TL/Ad.
6735 27 0300	300	405	5	1.409,25

**14000 004238**
**Katlanabilir Budama Testeresi**  
 Foldable Pruning Saw

KOD CODE	L mm	g		TL/Ad.
14000 004238	120	180	5	1.179,50

**05890 50 830**
**Testere Kolu**  
 Hacksaw Frame

 Yedek parça sayfa 255-259  
 Spare parts page 255-259

KOD CODE	L mm	g		TL/ Ad.
05890 50 830	300	570	5	1.406,50

**6195 26 0260**
**Perçin Tabancası**  
 Riveting Pliers

**YENİ TASARIM**  
 NEW DESIGN

 2.4 - 2.5 - 3 - 3.2 - 4 - 4.8 Pop perçin kullanımına uygundur.  
 It is suitable for use with 2.4 - 2.5 - 3 - 3.2 - 4 - 4.8 pop rivets.

KOD CODE	ÖLÇÜ SIZE	CAPACITY mm	g		TL/Ad.
6195 26 0260	260	2 - 2.5 - 3 - 3.2	615	1	1.484,50

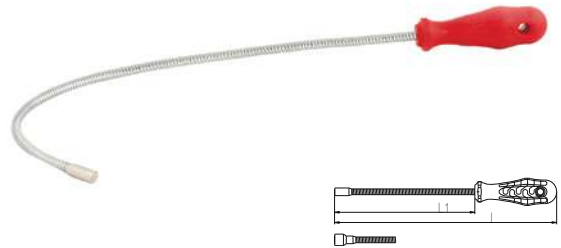
**6220**
**Spiralli Mıknatıs**  
 Flexible Magnet Holder

KOD CODE	KAPASİTE g	L mm	L1 mm	g		TL/ Ad.
6220 26 0500	500	465	375	80	10	934,75
6220 26 1000	1000	465	375	80	10	989,25

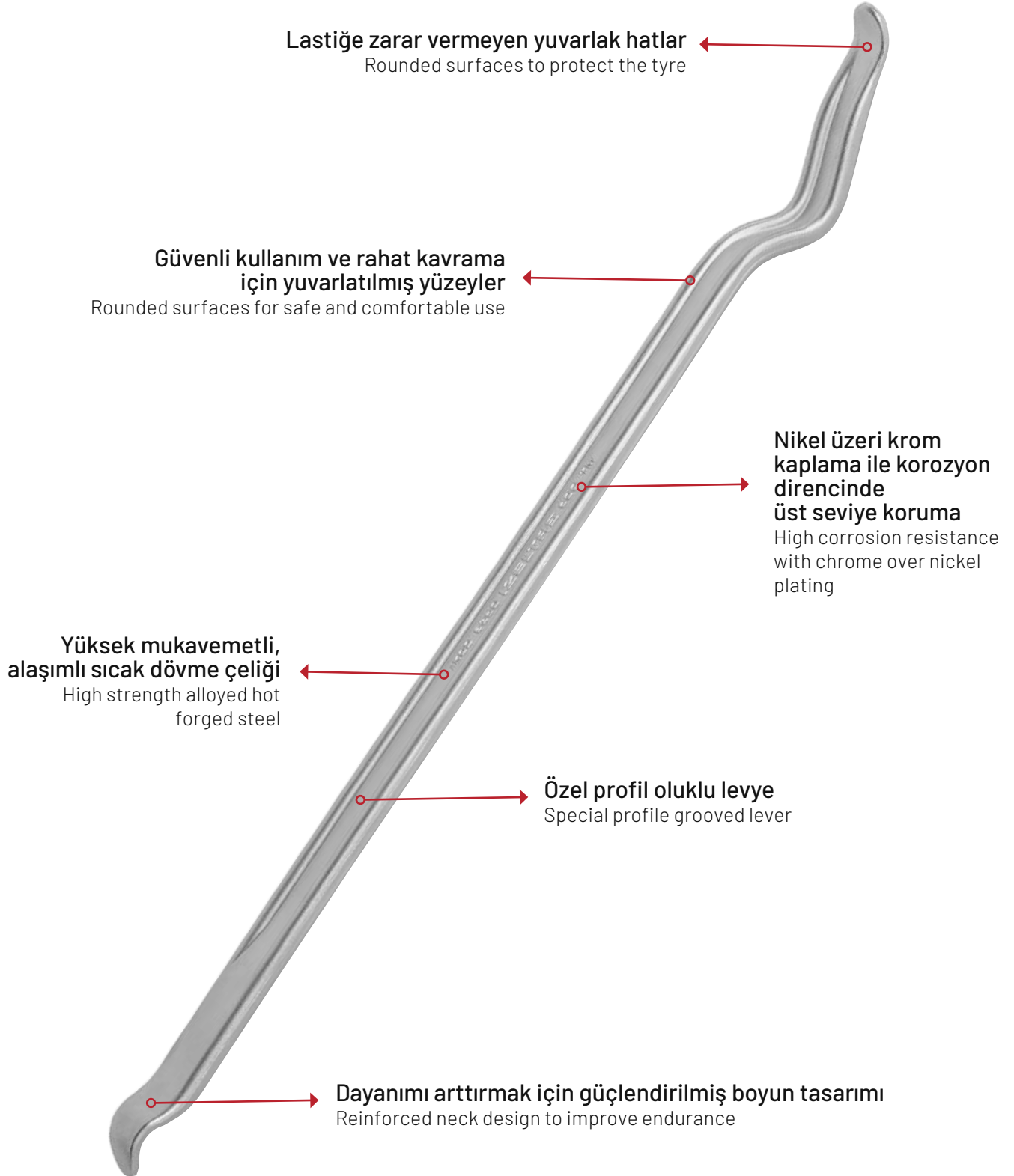
**LEVYE OLUKLU KIVRIK UÇLU / TYRE LEVER BENT**

**6230**
**Gres Pompası**  
Grease Gun

 Yedek parça sayfa 255-259  
Spare parts page 255-259

KOD CODE	ÖLÇÜ SIZE cc	g		TL/Ad.
6230 26 0300	300	1200	1	1.202,75
6230 26 0500	500	1255	1	1.480,50

**6240 26 0810**
**Tapa Anahtarı (iki ağız)**  
Offset Wrench For Carter Case

 Krom vanadyum, Krom kaplı  
Chrom vanadium, Chrom plated

KOD CODE	ÖLÇÜ mm	g		TL/Ad.
6240 26 0810	8x10	250	10	471,00

**6350**
**Levye Oluklu**  
Tyre Lever, Straight

TSEK

 Krom vanadyum, Krom kaplı  
Chrom vanadium, Chrom plated

KOD CODE	L mm	L inch	g		TL/Ad.
6350 26 0300	300	12"	255	5	446,25
6350 26 0400	400	16"	455	5	562,50
6350 26 0500	500	20"	655	5	781,25
6350 26 0600	600	24"	920	5	955,25

**6225**
**Madeni Yağdanlık (Flexible Uçlu)**  
Oiler With Flexible Spout

KOD CODE	ÖLÇÜ SIZE cc	g		TL/Ad.
6225 26 0200	200	140	5	497,00
6225 26 0300	300	160	5	558,50
6225 26 0500	500	205	5	613,25

**6360 26 0600**
**Levye Oluklu Kıvrık Uçlu**  
Tyre Lever, Bent

TSEK

 Krom vanadyum, Krom kaplı  
Chrom vanadium, Chrom plated

KOD CODE	L mm	L inch	g		TL/Ad.
6360 26 0600	600	24"	930	5	1.055,00

**14000 005358**
**Topuklu Keçe Levye**  
Prybar

KOD CODE	L mm	g		TL/Ad.
14000 005358	400	455	5	2.387,25

6375 26 6512

Çift Yönlü Üç Ayaklı Yağ Filtresi Sökeceği  
Left and Right Hand Operation, Triple Leg Oil Filter Wrench



3/8" - 1/2"

KOD CODE	Ø mm	g	TL/Ad.
6375 26 6512	75-120	605	5 2.435,25

06374 50 140

Zincirli Yağ Filtresi Sökeceği  
Chain Wrench



KOD CODE	Ø mm	g	TL/Ad.
06374 50 140	60x140	375	5 1.470,75

6380 26 6016

Çift Zincirli Yağ Filtresi Sökeceği  
Oil Filter Wrench With Double Chain



KOD CODE	Ø mm	g	TL/Ad.
6380 26 6016	60-160	950	5 6.591,25

6370 26 0100

Yağ Filtresi Sökeceği  
Band Type Oil Filter Wrench



KOD CODE	Ø mm	g	TL/Ad.
6370 26 0100	75 - 100	330	5 696,75

06373 50 140

Kayıslı Yağ Filtresi Sökeceği  
Strap Wrench



KOD CODE	Ø mm	g	TL/Ad.
06373 50 140	60x140	270	5 1.706,25

06375 50 100

Ayarlı Yağ Filtresi Sökeceği  
Adjustable Slot Type Oil Filter Wrench



 Yedek parça sayfa 255-259  
Spare parts page 255-259

KOD CODE	Ø mm	g	TL/Ad.
06375 50 100	65-110	215	5 815,50

06390

### Segman Çemberi Piston Ring Compressor



KOD CODE	Ø mm	g	□	TL/Ad.
06390 50 125	125	245	5	1.454,50
06390 50 175	175	530	5	2.776,00

07415

### Sıralı Tel Fırça (Ağaç Saplı) Hand Brush (Wooden Handle)

 YENİ TASARIM  
NEW DESIGN

KOD CODE	ÖLÇÜ SIZE	g	□	TL/Ad.	
07415 50 003	3 Sıra	3 Rows	105	5	108,50
07415 50 004	4 Sıra	4 Rows	105	5	115,25
07415 50 005	5 Sıra	5 Rows	140	5	129,00
07415 50 006	6 Sıra	6 Rows	150	5	137,00

07416 50 001

### Kıvrık Uçlu Fırça (Plastik Saplı) Hand Brush (PP Handle)



KOD CODE	L mm	g	□	TL/Ad.
07416 50 001	250	110	5	170,00

07410 50 010

### Makaralı Uzatma Kablosu (El Tipi) Extension Cord Reel (With Handle)

 YENİ TASARIM  
NEW DESIGN

#### TEKNİK ÖZELLİKLER / TECHNICAL DATA

Nominal Gerilim / Nominal Voltage	230V- 50/60Hz
Akım / Current	Max. 16A
Kablo Sarılı Halde Maks. Güç / Load Reeled	1000W
Kablo Açılmış Halde Maks. Güç / Extended Max.	3680W
Soket Tipi / Socket Type	4x2 P + E
Soket Standardı /Socket Standart	Schuko (F-type)
Kablo / Cable	Max. ø 3x1.5mm
Giriş Koruması / Ingress Protection	IP44-IP20

KOD CODE	MODEL	ÖLÇÜ SIZE	g	□	TL/Ad.
07410 50 010	El tipi / With handle	10	1780	1	3.364,25

07410

### Makaralı Uzatma Kablosu (Ayaklı) Extension Cord Reel (With Stand)

 YENİ TASARIM  
NEW DESIGN

#### TEKNİK ÖZELLİKLER / TECHNICAL DATA

Nominal Gerilim / Nominal Voltage	230V- 50/60Hz
Akım / Current	Max. 16A
Kablo Sarılı Halde Maks. Güç / Load Reeled	1000W
Kablo Açılmış Halde Maks. Güç / Extended Max.	3680W
Soket Tipi / Socket Type	4x2 P + E
Soket Standardı /Socket Standart	Schuko (F-type)
Kablo / Cable	Max. ø 3x1.5mm
Giriş Koruması / Ingress Protection	IP44-IP20

KOD CODE	MODEL	ÖLÇÜ SIZE	g	□	TL/Ad.
07410 50 025	Ayaklı / With stand	25	3850	1	5.944,00
07410 50 050	Ayaklı / With stand	50	6100	1	11.869,00



14000 004446

W444T Multi Sprey 400ml  
W444T Multi Spray 400ml



- ✓ Çok amaçlı kullanım
  - Multipurpose usage
- ✓ Paslanmış civata-somun bağlantılarını gevşetir
  - Loosens rust
- ✓ Hassas mekanizmaları yağlar
  - Eliminates squeaky noises
- ✓ Nemi bertaraf eder
  - Removes humidity
- ✓ Metalleri paslanmaya karşı korur
  - Protects and preserves tools
- ✓ Mükemmel temizlik yapar
  - Cleans metal surfaces



KOD/CODE	 ml	 g		TL/Ad.
14000 004446	400	380	12	416,25

14000 005274



 Fren ve Balata Temizleyici 500ml  
 Brake Cleaner 500ml





14000 005275

 Sıvı Gres 400ml  
 Liquid Grease 400ml

- ✓ Frenler (tambur ve disk frenler, fren balataları, fren pabuçları, silindirler, yaylar ve burçlar)
  - On brakes (drum and disk brakes, linings, brake pads, cylinders, springs and bushes)
- ✓ Debriyajlar (debriyaj balataları ve parçaları)
  - On clutches (clutch linings and components)
- ✓ Motor parçaları (karbüratörler, benzin ve yağ pompaları, şanzımanlar vs.)
  - On engine components (carburetors, fuel and oil pumps, transmissions etc.)

- ✓ Güç aktaran parçalar
  - For long-lasting lubrication of power-transmitting bolts and pins
- ✓ Dişliler ve dişli çarklar
  - toothed wheels and wormgear
- ✓ Hızlı hareket eden makine parçaları
  - fast-moving engine parts
- ✓ Hareketli parçalar ve şanzımanlar
  - joints and clutches
- ✓ Tekerlekler ve bilyeli yataklar
  - roller and ball bearings
- ✓ Yay paketleri
  - spring packs

KOD/CODE	 ml	 g		TL/Ad.
14000 005274	500	465	12	213,50

KOD/CODE	 ml	 g		TL/Ad.
14000 005275	400	355	12	398,25

## DÖVME ÇELİK MENGENE / FORGED STEEL VICE WITH SWIVEL BASE

**Isıl işlem sonrasında ilave olarak yapılan  
indüksiyonda sertleştirme işlemi ile güçlü tutuş  
sağlayan özel profilli çeneler**

Heat treated and induction hardened special profile jaws  
for powerful grip

**İndüksiyonda  
sertleştirilmiş darbeye  
dayanıklı yüzeyler**

Induction hardened impact  
resistant surfaces

**Yüksek  
karbonlu sıcak dövme  
çeliği ile artırılmış  
dayanım**

Improved lifetime with hot  
forged high carbon steel

**Elektrostatik fırın  
boya ile korozyon  
direnci sağlanmış  
yüzeyler**

High corrosion  
resistance with  
electrostatic powder  
paint

**İndüksiyonda  
sertleştirme ile  
kullanım ömrü  
arttırılmış, korozyona  
karşı çinko ile  
kaplanmış ilerleme mili**

High strength alloyed steel.  
High corrosion protection  
with chrome over nickel  
plating

**Yüksek mukavemetli,  
alaşımli çelik  
Nikel üzerine krom  
kaplama ile sağlanan,  
korozyon direncinde üst  
seviye koruma**

High strength alloyed steel.  
High corrosion protection  
with chrome over nickel  
plating

**Çevirme kolunun  
yerinden çıkmaması için  
kullanılan kauçuklar**

Rubber stoppers to keep  
the bar on the spindle

**Çelik döküm  
mengene altlığı**

Cast steel base plate

**Mengenenin 360°  
dönmesini sağlayan  
çelik döner parça**

Vice plate for 360° rotation

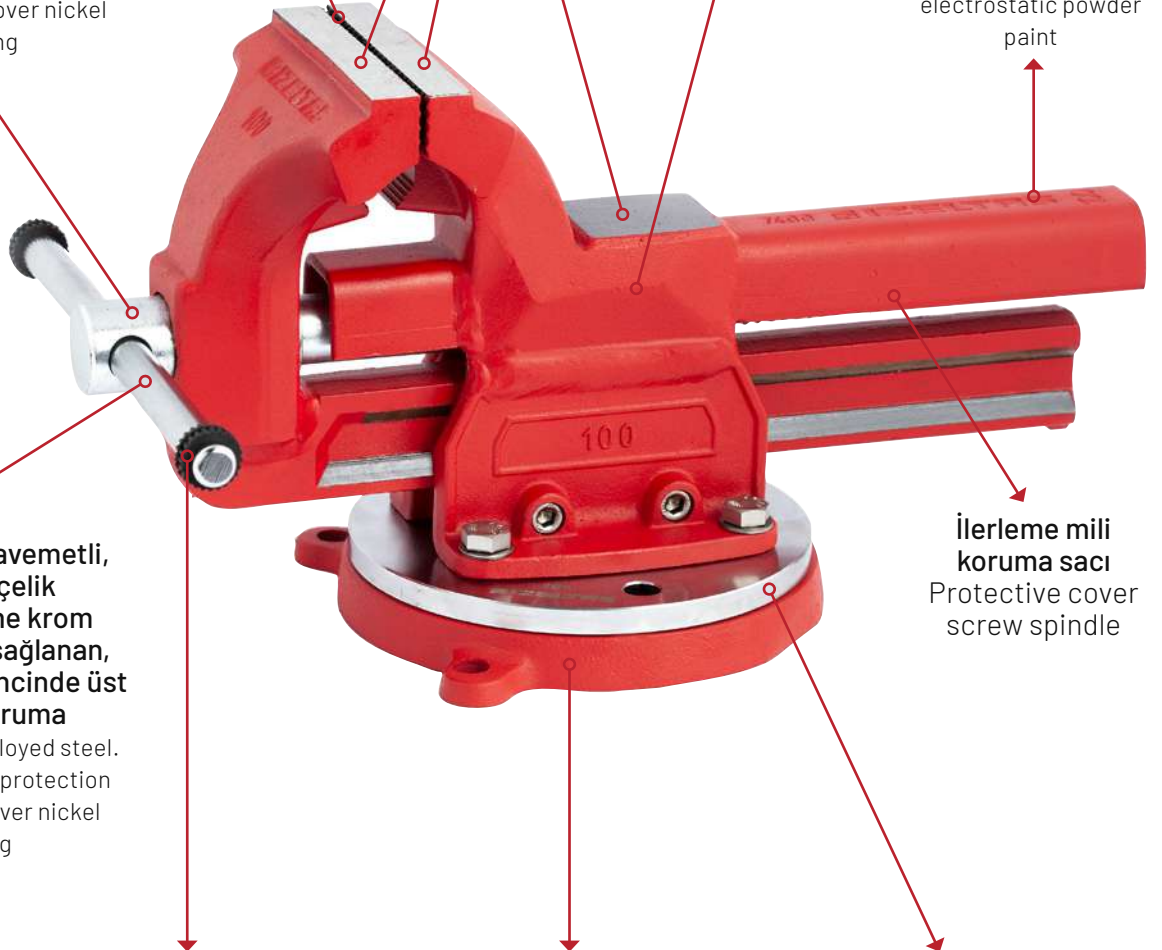

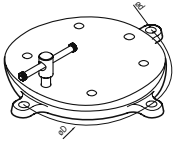
**7401**
**Mengene Döner Tablası**  
 Swivel Base of Vice

 Özel alaşım çelik  
 Special steel

KOD CODE	ÖLÇÜ SIZE	$\sigma d$ mm	$\sigma D$ mm	g	□	TL/Ad.
7401 30 0100	100	10.5	160	1565	1	2.248,00
7401 30 0125	125	12.5	200	4440	1	3.603,75
7401 30 0150	150	12.5	240	2715	1	2.968,75
7401 30 0175	175	12.5	280	6750	1	4.074,25

**7400**
**Dövme Çelik Mengene**  
 Forged Steel Vice

 Özel alaşım çelik, Fırın boya  
 Special steel, Electrostatic Paint

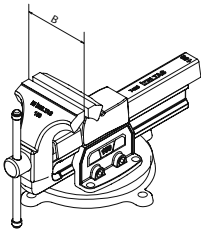
KOD CODE	B mm	W mm	H mm	L mm	g	□	TL/Ad.
7400 30 0100	100	125	148	440	5050	1	8.464,00
7400 30 0125	125	155	183	550	11000	1	11.491,25
7400 30 0150	150	180	220	675	20000	1	16.482,00
7400 30 0175	175	205	245	760	29000	1	22.272,50

**7400**
**Dövme Çelik Mengene (Döner Tabla dahil)**  
 Forged Steel Vice with Swivel Base

KOD CODE	B mm	g	□	TL/Ad.
7400 00 0100	100	6615	1	10.712,00
7400 00 0125	125	13715	1	14.460,00
7400 00 0150	150	24440	1	20.085,75
7400 00 0175	175	35750	1	26.346,75

## Tesviyeci Mengenesi Machinist Forged Steel Vise

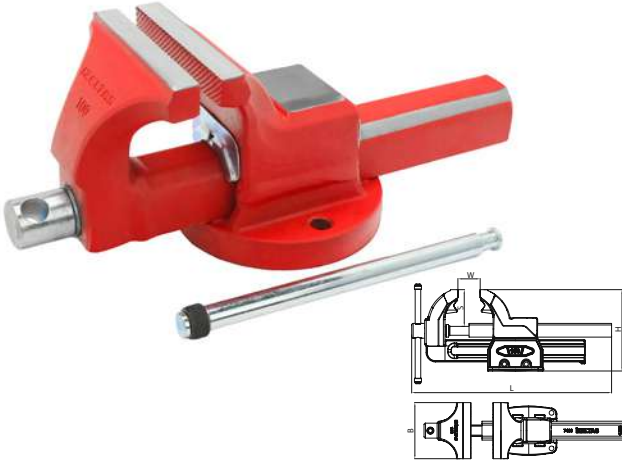

Özel alaşım çelik, Fırın boya  
Special steel, Electrostatic Paint

KOD CODE	B mm	W mm	H mm	L mm	g	TL/Ad.
14000 005070	100	125	120	308	5445	1 6.951,75
14000 005069	125	160	140	388	11320	1 9.362,25
14000 005072	150	190	190	480	19450	1 14.985,50
14000 005071	175	205	200	520	25300	1 17.928,00

7300

## İşkence (Marangoz Mengenesi Plastik Ağızlı) Carpenter Screw Clamp



Darbeye dayanıklı çeneler  
Impact resistant cast iron jaws

KOD CODE	a mm	b mm	g	TL/Ad.
7300 30 3012	30x12	300	120	1530 5 1.774,50
7300 30 4012	40x12	400	120	1745 5 2.097,50
7300 30 5012	50x12	500	120	1935 5 2.149,25
7300 30 6012	60x12	600	120	2095 5 2.243,75
7300 30 8012	80x12	800	120	2450 5 2.379,25
7300 30 1012	100x12	1000	120	2650 5 2.714,50

## Tesviyeci Mengene Döner Tabla Swivel Base Of Machinist Vise

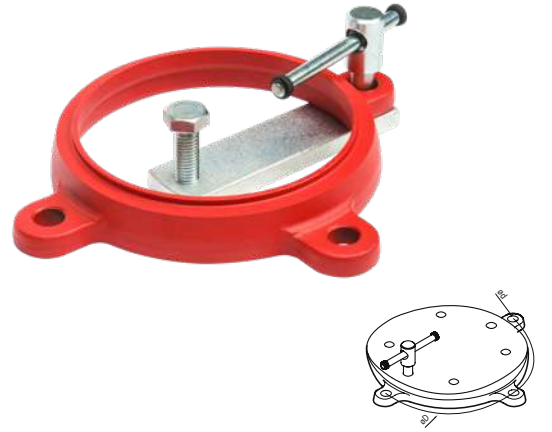

Özel alaşım çelik, Fırın boya  
Special steel, Electrostatic Paint

KOD CODE	ÖLÇÜ SIZE	σd mm	σD mm	g	TL/Ad.
14000 005126	100	11.5	150	905	1 1.594,75
14000 005127	125	13.5	185	1495	1 1.988,50
14000 005128	150	16	225	2140	1 2.518,00
14000 005129	175	17.5	250	2630	1 2.762,75

7310

## Mini İşkence Mini Clamp



Darbeye dayanıklı çeneler  
Impact resistant cast iron jaws

KOD CODE	a mm	b mm	g	TL/Ad.
7310 30 1005	10x5	100	50	325 5 765,00
7310 30 1505	15x5	150	50	345 5 804,75
7310 30 2005	20x5	200	50	380 5 834,50
7310 30 2505	25x5	250	50	400 5 870,25
7310 30 3005	30x5	300	50	430 5 901,75

# AYDINLATMA

## LIGHTING

- Çalışma Lambası  
Work Light
- Fener  
Torch Light

- Kafa Lambası  
Head Lamp



14000 005346

## 1000 LM Led El Feneri

### 1000 LM Led Flashlight

#### TEKNİK ÖZELLİKLER / TECHNICAL DATA

1. Mod / Mode	Yüksek High	Orta Middle	Düşük Low	Gizli Atar Işık Hidden Strobe	SOS
Işık Gücü / Output (Lümen / Lumen)	1000	500	80	-	-
Çalışma Süresi / Battery Life (Saat / Hour)	3	3,5	10	-	-

2. Mod / Mode	Yüksek High	Orta Middle
Işık Gücü / Output (Lümen / Lumen)	250	35
Çalışma Süresi / Battery Life (Saat / Hour)	4,5	17

❗ Şarj adaptörü dahil değildir / Charger not included

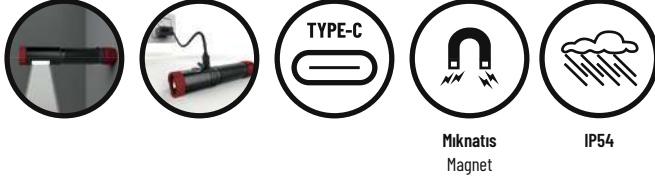

Mıknatis  
Magnet

IP54



İZELTAS YOUTUBE



KOD / CODE	Pil / Battery	Şarj Süresi (Saat) Charging Time (Hour)	g	L mm	TL/Ad.
14000 005346	2600 mAh Li-Ion 18650	4-5	118	124	1 2.431,00

14000 005345

## 1000 LM Pro Led El Feneri

### 1000 LM Pro Led Flashlight

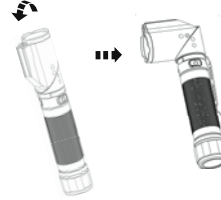

#### TEKNİK ÖZELLİKLER / TECHNICAL DATA

LED	Samsung   395 nm UV   Kırmızı Lazer - Red Laser				
Mod / Mode	Yüksek High	Orta Middle	Düşük Low	Gizli UV Hidden UV	Kırmızı Lazer + Yüksek Red Laser + High
Işık Gücü / Output (Lümen / Lumen)	1000	500	200	-	-
Çalışma Süresi / Battery Life (Saat / Hour)	2	2,5	12	-	-

❗ Şarj adaptörü dahil değildir / Charger not included



İZELTAS YOUTUBE

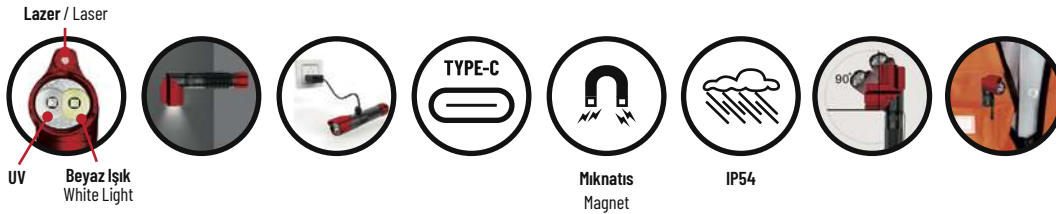

UV  
Beyaz Işık  
White Light

Mıknatis  
Magnet

IP54

KOD / CODE	Pil / Battery	Şarj Süresi (Saat) Charging Time (Hour)	g	L mm	TL/Ad.
14000 005345	2600 mAh Li-Ion 18650	3-4	209,2	158	1 3.434,00

14000 005347

 400 LM Led Kafa Feneri Hareket Sensörlü  
 400 LM Led Headlamp with Sensor



## TEKNİK ÖZELLİKLER / TECHNICAL DATA

LED	Samsung   Lumiled		
Mod / Mode	Nokta Spot	Işıldak Flood	Hepsi Açık All-On
Işık Gücü / Output (Lümen / Lumen)	200	100	400
Çalışma Süresi / Battery Life (Saat / Hour)	9	17	4

⚠ Şarj adaptörü dahil değildir / Charger not included  
 Pil değiştirilebilir değildir / Battery is non-replacable

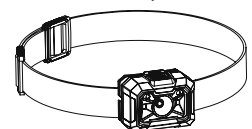

İZELTAŞ YOUTUBE

 Algılayıcı Aç/Kapat  
 Sensor On/Off

 Geniş  
 Wide

 Dar  
 Spot

IP65

KOD / CODE	Pil / Battery	Şarj Süresi (Saat) Charging Time (Hour)	g	L mm	1	TL/Ad.
14000 005347	1500 mAh LiPo	2-3	90.4	61	1	1.957,75

14000 005344

 450 LM Cob Led Kafa Feneri  
 400 LM Led Headlamp



## TEKNİK ÖZELLİKLER / TECHNICAL DATA

LED	COB LED		
Mod / Mode	Yüksek High	Orta Middle	Düşük Low
Işık Gücü / Output (Lümen / Lumen)	450	140	25
Çalışma Süresi / Battery Life (Saat / Hour)	1,5	3	13

⚠ Şarj adaptörü dahil değildir / Charger not included

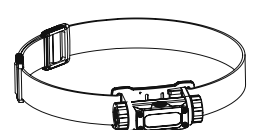
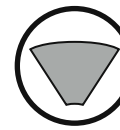
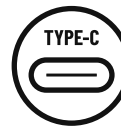

İZELTAŞ YOUTUBE

 Alüminyum Çerçeve  
 Aluminum Frame

 Geniş  
 Wide

IP65

KOD / CODE	Pil / Battery	Şarj Süresi (Saat) Charging Time (Hour)	g	L mm	1	TL/Ad.
14000 005344	880 mAh Li-Ion 14500	2-3	83	65	1	2.238,50

14000 005383

### 600 LM Cob Led Çalışma Lambası

### 600 LM Cob Led Work Light



#### TEKNİK ÖZELLİKLER / TECHNICAL DATA

Mod / Mode	Yüksek High	Orta Middle	Üst Işık Top Light
Işık Gücü / Output (Lümen / Lumen)	600	200	200
Çalışma Süresi / Battery Life (Saat / Hour)	3	12	9

⚠ Şarj adaptörü dahil değildir / Charger not included

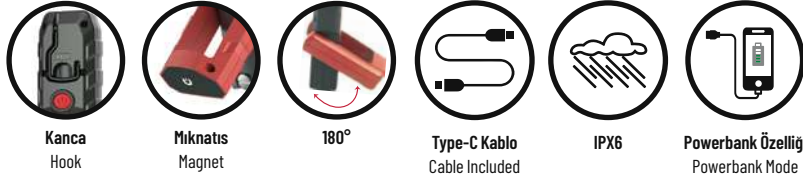

İZELTAS YOUTUBE

Kanca  
HookMıknatıs  
Magnet

180°

Type-C Kablo  
Cable Included

IPX6

Powerbank Özelliği  
Powerbank Mode

KOD / CODE	Pil / Battery	Şarj Süresi (Saat) Charging Time (Hour)	g	L mm	TL/Ad.
14000 005383	4000 mAh Li-Ion	3	380	205	1.904,00

14000 005382

### 400 LM Cob Led Katlanır Çalışma Lambası

### 400 LM Cob Led Rotating Work Light



#### TEKNİK ÖZELLİKLER / TECHNICAL DATA

Mod / Mode	Yüksek High	Üst Işık Top Light	Tepe Işık Spot Light
Işık Gücü / Output (Lümen / Lumen)	400	150	50
Çalışma Süresi / Battery Life (Saat / Hour)	3	10	40

⚠ Şarj adaptörü dahil değildir / Charger not included



İZELTAS YOUTUBE

Üst Led 150 LM  
150 LM Top Led10 LM Kırmızı Cob Led  
10 LM Red Cob Led

400 LM

Ayarlı Sıkıştırma  
Aparatı  
Adjustable Grip

TYPE-C

IPX6

Mıknatıs  
Magnet

KOD / CODE	Pil / Battery	Şarj Süresi (Saat) Charging Time (Hour)	g	L mm	TL/Ad.
14000 005382	2600 mAh Li-Ion	4	305	158	1.624,50

14000 005386

 400 LM Cob Led Çalışma Lambası  
 400 LM Cob Led Work Light

## TEKNİK ÖZELLİKLER / TECHNICAL DATA

Mod / Mode	Yüksek High	Orta Middle	Üst Işık Top Light
Işık Gücü / Output (Lümen / Lumen)	400	120	200
Çalışma Süresi / Battery Life(Saat / Hour)	3,5	9	5

⚠ Şarj adaptörü dahil değildir / Charger not included

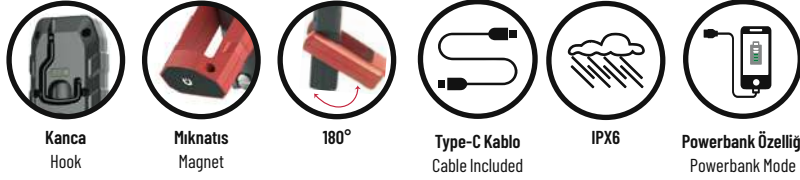

İZELTAS YOUTUBE



KOD / CODE	Pil / Battery	Şarj Süresi (Saat) Charging Time (Hour)	g	L mm	TL/Ad.
14000 005386	2200 mAh Li-Ion	3	290	180	1.547,75

14000 005384

 200 LM Cob Led Çalışma Lambası  
 200 LM Cob Led Work Light

## TEKNİK ÖZELLİKLER / TECHNICAL DATA

Mod / Mode	Yüksek High	Orta Middle	Üst Işık Top Light
Işık Gücü / Output (Lümen / Lumen)	200	50	50
Çalışma Süresi / Battery Life(Saat / Hour)	2	8	4

⚠ Şarj adaptörü dahil değildir / Charger not included

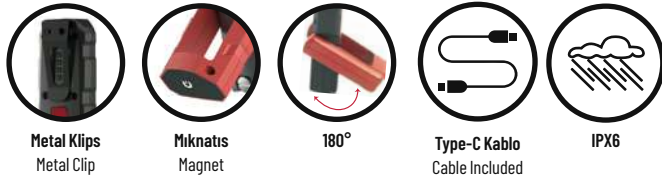

İZELTAS YOUTUBE



KOD / CODE	Pil / Battery	Şarj Süresi (Saat) Charging Time (Hour)	g	L mm	TL/Ad.
14000 005384	750 mAh Li-Ion	2	155	155	1.154,25

14000 005385

 300 LM Cob Led Kalem Tipi Fener  
 300 LM Pro Led Pen Light

## TEKNİK ÖZELLİKLER / TECHNICAL DATA

Mod / Mode	Yüksek High	Lazer Laser	Üst Işık Top Light
Işık Gücü / Output (Lümen / Lumen)	300	-	200
Çalışma Süresi / Battery Life(Saat / Hour)	2,5		

⚠ Şarj adaptörü dahil değildir / Charger not included



İZELTAS YOUTUBE

KOD / CODE	g	L mm	TL/Ad.
14000 005385	100	170	1.188,50



- Maket bıçağı ucu, kullanılmadığı zamanlarda gövdenin içinde kapalı konumda tutulmalıdır.
- Maket bıçağı, kullanımı sırasında kesme yapılan parça sabitlenmeli veya düz bir zemin üzerine konularak kesme işlemi güvenli ve dikkatli bir şekilde gerçekleştirilmelidir.
- Maket bıçağı, kullanımı sırasında kesme yönü vücudumuzdan uzaklaştırma yönünde olmalıdır.
- Maket bıçağı, kullanımı sırasında kesilen parçaya göre elimizden veya vücudumuzdan uzak tutulmalıdır.
- Maket bıçağı, kullanımı sırasında kesici uç kesilecek parçaya göre açılmalıdır. Gereğinden fazla açılan uç kırılmaya sebep olacaktır.
- Maket bıçağını amacı dışında kullanmak kazalara neden olacaktır. (Tornavida - Sıyırıcı - Kazıyıcı gibi)



- Utility knife blade should be kept in the closed position inside the handle when not in use.
- During the use of the utility knife, the material being cut should be secured or placed on a flat surface to ensure safe and careful cutting.
- The cutting direction during the use of the utility knife should be away from our body.
- During the use of the utility knife, we should keep our hands and body away from the cutting area according to the piece being cut.
- The cutting edge of the utility knife should be angled based on the material to be cut. Opening the edge too much can cause breakage.
- Using the utility knife for purposes other than its intended use can lead to accidents (e.g., As a screwdriver, scraper, or chisel).
- During the use of the utility knife, protective gloves and safety glasses should be worn.
- The appropriate utility knife should be chosen according to the type of cutting work to be done.

- Maket bıçağı kullanım sırasında koruyucu eldiven ve gözlük kullanılmalıdır.
- Maket bıçağı, ıslak, nemli ve yağlı ortamlarda muhafaza edilmemelidir.
- Maket bıçağı, yıpranmış ve kırılmış uçlarla kullanılmamalıdır. Yıpranan ve kırılan uç, işaretli yerinden kırılmalı veya yan kesici uc ile kullanılmalıdır. Kırılan ve değiştirilen uçlar ayrı bir kutuda toplanmalıdır.
- Maket bıçağının körelen veya yıpranmış ucu, işaretli yerlerden kıracağıımız esnada pense vb. ağızları arasında sıkıca tutularak kırılmalıdır. Böylece vücudunuza zarar vermesinin önüne geçilecektir.
- Maket bıçağı, gövdesi zarar görmüş ve kilit mekanizması bozulmuş ise kullanılmamalıdır.
- Maket bıçağı, kesimi yapılacak işe uygun maket bıçağı seçilerek yapılmalıdır.
- Maket bıçağı ucu, gövdeye takılı olarak kullanılmalıdır. Sadece ucu kullanmak ciddi yaralanmalara sebep olabilir.
- Maket bıçağı, takım dolapları ve takım çantası içerisine konulurken ucunun kapalı olduğundan emin olunmalıdır.

- The utility knife blade should be used with the handle attached to the body. Using only the blade can result in serious injuries.
- When placing the utility knife in tool cabinets and tool bags, make sure that the blade is closed.
- The utility knife should not be stored in wet, humid, or oily environments.
- Worn or broken blades of the utility knife should not be used. They should be discarded in a separate box after breakage and replaced with a new cutting edge.
- When breaking a dull or worn blade of the utility knife from the marked areas, it should be held tightly between the jaws of pliers, etc., To prevent harm to the body.
- Utility knives with damaged bodies or faulty locking mechanisms should not be used.



# MAKET BIÇAKLARI

UTILITY KNIVES

- Maket Biçakları  
Utility Knives
- Maket Biçakları Yedek Uçları  
Utility Knives Spare Blades



14000 005051

**Pro Güvenlikli Otomatik Kilitlemeli Trapez Maket Bıçağı (2 Yedek Bıçaklı)**  
Pro Safety Auto- Locking Utility Knife



- **Otomatik Kilit Mekanizması** / Auto-Lock Mechanism
- **Metal Gövde** / Metal-Bodied
- **Kauçuk Kaplamalı** / Rubber Coated
- **Ergonomik Yapı** / Ergonomic Design
- **Trapez Bıçak** / Trapeze Knife
- **2 Yedek Bıçaklı** / 2 Spare Blades
- **Otomatik Emniyet Mandalı** / Auto Safety Button
- **Askı Delikli** / Hanging Hole

KOD/CODE	L mm	g	TL/Ad.
14000 005051	175	235	765,00

14000 005050

**Pro Metal Gövde Emniyetli Otomatik Kilitli Maket Bıçağı 18mm**  
Pro Safety Metal-Bodied Auto-Locking Utility Knife 18 mm



- **Otomatik Kilit Mekanizması** / Auto-Lock Mechanism
- **Metal Gövde** / Metal-Bodied
- **Kauçuk Kaplamalı** / Rubber Coated
- **Ergonomik Yapı** / Ergonomic Design
- **18 mm Bıçak Genişliği** / 18 mm Blade Width
- **Bıçak Kırma Yeri** / Knife Breaking Part
- **Emniyetli Kesim** / Safety Cutting
- **Askı Delikli** / Hanging Hole

KOD/CODE	L mm	g	TL/Ad.
14000 005050	195	200	626,75

**14000 005049**

Pro Metal Gövde Maket Bıçağı 18 mm  
Pro Metal-Bodied Utility Knife 18 mm



- **Otomatik Kilit Mekanizması** / Auto-Lock Mechanism
- **Metal Gövde** / Metal-Bodied
- **Kauçuk Kaplamalı** / Rubber Coated
- **Ergonomik Yapı** / Ergonomic Design
- **18 mm Bıçak Genişliği** / 18 mm Blade Width
- **Bıçak Kırma Yeri** / Knife Breaking Part
- **Askı Delikli** / Hanging Hole

KOD/CODE	L mm	g	TL/Ad.
14000 005049	172	145	386.00

**14000 005047**

Pro Metal Gövde Otomatik Yükllemeli Maket Bıçağı (5 Yedekli) 9 mm  
Pro Metal-Bodied Auto-Loading Utility Knife 9 mm



- **Otomatik Kilit Mekanizması** / Auto-Lock Mechanism
- **Metal Gövde** / Metal-Bodied
- **Kauçuk Kaplamalı** / Rubber Coated
- **Ergonomik Yapı** / Ergonomic Design
- **9 mm Bıçak Genişliği** / 9 mm Blade Width
- **Otomatik Yükllemeli** / Auto Loading
- **Askı Delikli** / Hanging Hole
- **5 Adet Yedek Bıçaklı** / 5 Spare Blades

KOD/CODE	L mm	g	TL/Ad.
14000 005047	136	90	402.50

14000 005053

Pro Metal Gövde Maket Bıçağı 30° 9 mm  
Pro Metal-Bodied Utility Knife 30° Angled 9 mm



- Otomatik Kilit Mekanizması / Auto-Lock Mechanism
- Metal Gövde / Metal-bodied
- 9 mm Bıçak Genişliği / 9 mm Blade Width

KOD/CODE	L mm	g	TL/Ad.
14000 005053	134	25	81,00

14000 005052

Pro Metal Gövde Maket Bıçağı 9 mm  
Pro Metal-Bodied Utility Knife 9 mm



- Otomatik Kilit Mekanizması / Auto-Lock Mechanism
- Metal Gövde / Metal-bodied
- 9 mm Bıçak Genişliği / 9 mm Blade Width
- Kauçuk Kaplamalı / Rubber Coated
- Ergonomik Yapı / Ergonomic Design
- Askı Delikli / Hanging Hole

KOD/CODE	L mm	g	TL/Ad.
14000 005052	130	60	273,75

14000 005048

Pro Metal Gövde Emniyetli Otomatik Kilitli Maket Bıçağı 9 mm  
Pro Safety Metal Bodied Auto-Locking Utility Knife 9 mm



- Otomatik Kilit Mekanizması / Auto-Lock Mechanism
- Metal Gövde / Metal-bodied
- 9 mm Bıçak Genişliği / 9 mm Blade Width
- Kauçuk Kaplamalı / Rubber Coated
- Ergonomik Yapı / Ergonomic Design
- Emniyetli Kesim / Safety Cutting
- Askı Delikli / Hanging Hole

KOD/CODE	L mm	g	TL/Ad.
14000 005048	162	90	481,75

14000 005090

Pro Güvenlikli Trapez Maket Bıçağı Yedek Bıçak 18 mm  
Pro Safety Utility Knife Spare Blade 18 mm



Bir Paket 10 Bıçak, Bir Kutu 24 Paket

One Package Contains 10 Blades, One Box Contains 24 Packages

KOD/CODE	ÖLÇÜ / SIZE (mm)	TL/Ad.
14000 005090	18	123,25

14000 005088

Pro Maket Bıçağı Yedek Bıçak 18 mm  
Pro Utility Knife Spare Blade 18 mm



Bir Paket 10 Bıçak, Bir Kutu 24 Paket

One Package Contains 10 Blades, One Box Contains 24 Packages

KOD/CODE	ÖLÇÜ / SIZE (mm)	TL/Ad.
14000 005088	18	97,25

14000 005089

Pro Maket Bıçağı Yedek Bıçak 9 mm  
Pro Utility Knife Spare Blade 9 mm



Bir Paket 10 Bıçak, Bir Kutu 24 Paket

One Package Contains 10 Blades, One Box Contains 24 Packages

KOD/CODE	ÖLÇÜ / SIZE (mm)	TL/Ad.
14000 005089	9	61,75

14000 005091

Pro Maket Bıçağı Yedek Bıçak 30° Açılı 9 mm  
Pro Utility Knife Spare Blade 30° 9 mm



Bir Paket 10 Bıçak, Bir Kutu 24 Paket

One Package Contains 10 Blades, One Box Contains 24 Packages

KOD/CODE	ÖLÇÜ / SIZE (mm)	TL/Ad.
14000 005091	9	61,75

# MAKASLAR

## SHEARS

- Demir Kesme Makası  
Bolt Cutters
- Sac Makasları  
Sheet Metal Cutters
- Özel Amaçlı Makaslar  
Special Purpose Shears
- Baę Makasları  
Pruning Shears
- Boru Kesiciler  
Pipe Cutters



**Isıl işlem sonrasında ilave  
indüksiyonla sertleştirme ile kullanım  
ömrü arttırılmış kesici ağızlar**  
Heat-treated and induction hardened cutting  
edges for long lifetime

**PVC izoleli sap**  
PVC coated handle

**Kolları birleştirmeye  
yarayan kilit mandalı**  
Locking latch to keep the  
arms closed

**Uzun ömürlü yay**  
Long life spring

**Mangan Fosfat Kaplı  
Yüzeyler**  
Black finish

**Yüksek karbonlu  
sıcak dövme  
çeliği ile arttırılmış  
dayanım**  
High carbon hot forged  
steel for improved  
performance



İZELTAS YOUTUBE

**2350**
**Demir Kesme Makası**  
 Bolt Cutters

 Yedek parça sayfa 255-259  
 Spare parts page 255-259

Özel alaşımli çelik, Kesici ağızlar indüksiyonda sertleştirilmiş,  
 Elektrostatik boyanmış çeneler ve bağlantı parçaları dövme  
 Special steel, Cutters induction hardened,  
 Electrostatically painted jaws and connection parts drop forged

KOD CODE	L mm	L inch	KAPASİTE CAPACITY $\phi$ mm	g		TL/Ad.
2350 27 0018	450	18"	6 - 8	1930	1	2.897,75
2350 27 0024	600	24"	8 - 10	2710	1	4.265,75
2350 27 0030	750	30"	9 - 13	4465	1	6.676,00
2350 27 0036	900	36"	11 - 16	6690	1	8.640,50

**2350 00 6104**
**Demir Kesme Makası Sehpası (Dolu)**  
 Bolt Cutters Frame

KOD CODE	İÇERİK CONTENTS	g		TL/Ad.
2350 00 6104	18"(450) - 24"(600) 30"(750) - 36"(900)	21.110	4	27.610,00

**6205 27 0240**
**Alüminyum Ve Sac Kesme Makası Sağ**  
 Snip For Aluminum and Metal Sheet (Right)

Özel alaşımli çelik, Kesici ağızlar indüksiyonda sertleştirilmiş,  
 Special steel, Cutters induction hardened,

KOD CODE	L mm	L inch	g		TL/Ad.
6205 27 0240	240	10"	360	5	1.146,75

**6206 27 0240**
**Alüminyum Ve Sac Kesme Makası Sol**  
 Snip For Aluminum and Metal Sheet (Left)

Özel alaşımli çelik, Kesici ağızlar indüksiyonda sertleştirilmiş  
 Special steel, Cutters induction hardened

KOD CODE	L mm	L inch	g		TL/Ad.
6206 27 0240	240	10"	360	5	1.146,75

**6207 27 0240**
**Alüminyum Ve Sac Kesme Makası Düz**  
 Snip For Aluminum and Metal Sheet (Flat)

Özel alaşımli çelik, Kesici ağızlar indüksiyonda sertleştirilmiş  
 Special steel, Cutters induction hardened

KOD CODE	L mm	L inch	g		TL/Ad.
6207 27 0240	240	10"	360	5	1.146,75

**13000 001851**
**Alüminyum Ve Sac Kesme Makas Takımı (3 Parça)**  
 Aluminum and Metal Sheet Set (3 Pcs)

KOD CODE	L mm	L inch	g		TL/Ad.
13000 001851	240	10"	1110	5	3.440,25

6210

**Kaportacı Makası (Sağ)**  
Punch Snip (Right)

DIN 6438



Özel alaşımli çelik, Kesici ağızlar indüksiyonda sertleştirilmiş, PVC izoleli  
Special steel, Cutters induction hardened, PVC insulated

KOD CODE	L mm	L inch	g	TL/Ad.
6210 27 0250	250	10"	460	5 1.440,75
6210 27 0275	275	11"	615	5 1.576,25
6210 27 0300	300	12"	645	5 1.796,50

6211

**Kaportacı Makası (Sol)**  
Punch Snip (Left)

DIN 6438



Özel alaşımli çelik, Kesici ağızlar indüksiyonda sertleştirilmiş, PVC izoleli  
Special steel, Cutters induction hardened, PVC insulated

KOD CODE	L mm	L inch	g	TL/Ad.
6211 27 0250	250	10"	460	5 1.440,75
6211 27 0275	275	11"	615	5 1.576,25
6211 27 0300	300	12"	645	5 1.796,50

6820

**Tenekeci Makası**  
Tinman's Snip

YENİ TASARIM  
NEW DESIGN



Özel alaşımli çelik, Kesici ağızlar indüksiyonda sertleştirilmiş, PVC izoleli  
Special steel, Cutters induction hardened, PVC insulated

KOD CODE	L mm	L inch	g	TL/Ad.
6820 27 0200	200	8"	310	5 968,75
6820 27 0250	250	10"	500	5 1.238,25
6820 27 0300	300	12"	735	5 1.349,00

6821

**Tenekeci Makası (Yaylı)**  
Tinman's Snip (With Spring)

YENİ TASARIM  
NEW DESIGN



Özel alaşımli çelik, Kesici ağızlar indüksiyonda sertleştirilmiş, PVC izoleli  
Special steel, Cutters induction hardened, PVC insulated

KOD CODE	L mm	L inch	g	TL/Ad.
6821 27 0250	250	10"	510	5 1.345,00
6821 27 0300	300	12"	745	5 1.469,50

6800 27 0180

Kuyumcu Makası (Düz)  
Jeweller's Snip (Straight)

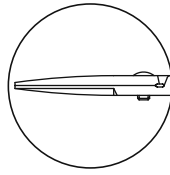

KOD CODE	L mm	L inch	g	TL/Ad.
6800 27 0180	180	7 1/8"	140	5 1.169,75

6801 27 0180

Kuyumcu Makası (Eğri)  
Jeweller's Snip (Curved)

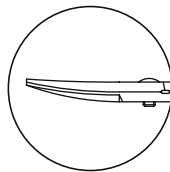

KOD CODE	L mm	L inch	g	TL/Ad.
6801 27 0180	180	7 1/8"	140	5 1.279,25

6815 27 0200

Tel Kesme Makası  
Bolt Cutters



KOD CODE	L mm	L inch	g	TL/Ad.
6815 27 0200	200	8"	280	5 592,75

13000 005122

Dövme Tel Kesme Makası  
Forging Bolt Cutters



Özel alaşımli çelik, Kesici ağızlar indüksiyonda sertleştirilmiş, PVC izoleli  
Special steel, Cutters induction hardened, PVC insulated

KOD CODE	L mm	L inch	g	TL/Ad.
13000 005122	210	7 1/8"	355	5 2.165,75

6740

Kombine Makas  
Multi Purpose Scissors



KOD CODE	L mm	L inch	g	TL/Ad.
6740 27 0140	140	5 1/2"	95	5 1.071,50
6740 27 0190	190	7 1/2"	120	5 1.256,00

6710 27 0230

Bağ Makası (Lüks)  
Pruning Shears (Lux)



İZELTAS YOUTUBE

Özel alaşımlı çelik, Kesici ağızlar indüksiyonda sertleştirilmiş, PVC izoleli  
Special steel, Cutters induction hardened, PVC insulated

KOD CODE	L mm	L inch	g	TL/Ad.
6710 27 0230	230	9"	280	5 1.079,75

6715 27 0225

Bağ Makası (Comfort)  
Pruning Shears (Comfort)



Özel alaşımlı çelik, PVC izoleli  
Special steel, PVC insulated

KOD CODE	L mm	L inch	g	TL/Ad.
6715 27 0225	225	9"	290	5 1.572,25

6720 27 0220

Bağ Makası (Hafif Tip)  
Pruning Shears (Light)



Alüminyum gövde, PVC izoleli  
Aluminum forged body, PVC insulated

KOD CODE	L mm	L inch	g	TL/Ad.
6720 27 0220	220	8 5/8"	260	5 1.825,25

6712 27 0210

Elma Makası  
Pruning Shears (Fruit)

YENİ TASARIM  
NEW DESIGN



Özel alaşımlı çelik, Kesici ağızlar indüksiyonda sertleştirilmiş, PVC izoleli  
Special steel, Cutters induction hardened, PVC insulated

KOD CODE	L mm	L inch	g	TL/Ad.
6712 27 0210	200	8"	265	5 1.827,75

14000 005137

**Budama Makası Dövme Örs Çeneli**  
Anvil Pruning Shears

Alüminyum gövde, PVC izoleli  
Aluminum forged body, PVC insulated

KOD CODE	L mm	L inch	g	TL/Ad.
14000 005137	210	8 1/4"	255	1.251,75

14000 005136

**Bağ Makası (Alüminyum Gövdeli)**  
Pruning Shears (Aluminum-Bodied)

Alüminyum gövde  
Aluminum forged body

1.444,75	L mm	L inch	g	TL/Ad.
14000 005136	220	8 5/8"	315	1.444,75

14000 005138

**Hasat Makası Paslanmaz Düz Ağızlı**  
Stainless Steel Straight-Edge Harvesting Shears

Paslanmaz Çelik  
Stainless Steel

KOD CODE	L mm	L inch	g	TL/Ad.
14000 005138	190	7 1/2"	85	738,75

06760

### Plastik Boru Kesme Makası Plastic Pipe Cutter



 Yedek parça sayfa 255-259  
Spare parts page 255-259

KOD CODE	Ø mm	g	□	TL/Ad.
06760 50 042	42	440	5	3.948,25
06760 50 063	63	605	5	6.926,50

6850 28 0322

### Mini Boru Kesici (Bakır ve Alüminyum İçin) Mini Tube Cutter (For Copper and Aluminum)



 Yedek parça sayfa 255-259  
Spare parts page 255-259

KOD CODE	ÖLÇÜ SIZE	g	□	TL/Ad.
6850 28 0322	1/8" - 5/8"	115	1	852,50

6855 28 0330

### Standart Boru Kesici (Bakır ve Alüminyum İçin) Standard Tube Cutter (For Copper and Aluminum)



 Yedek parça sayfa 255-259  
Spare parts page 255-259

KOD CODE	ÖLÇÜ SIZE	g	□	TL/Ad.
6855 28 0330	1/8" - 1 1/8"	335	1	1.179,50

6860 28 0635

### Teleskopik Boru Kesici (Bakır ve Alüminyum İçin) Telescopic Tube Cutter (For Copper and Aluminum)



 Yedek parça sayfa 255-259  
Spare parts page 255-259

KOD CODE	ÖLÇÜ SIZE	g	□	TL/Ad.
6860 28 0635	1/8" - 1 3/8"	335	1	2.505,00

6865 28 1050

### Profesyonel Boru Kesici (Çelik İçin) Professional Tube Cutter (For Steel)



 Yedek parça sayfa 255-259  
Spare parts page 255-259

KOD CODE	ÖLÇÜ SIZE	g	□	TL/Ad.
6865 28 1050	1/8" - 2"	2185	1	6.320,25



# ÇEKTİRMELER

## PULLERS

- Çektirmeler  
Pullers
- İç Rulman Çektirmeler  
Internal Pullers
- Dış Rulman Çektirmeler  
Seperator Pullers
- Rotil Çektirme  
Balljoint Pullers

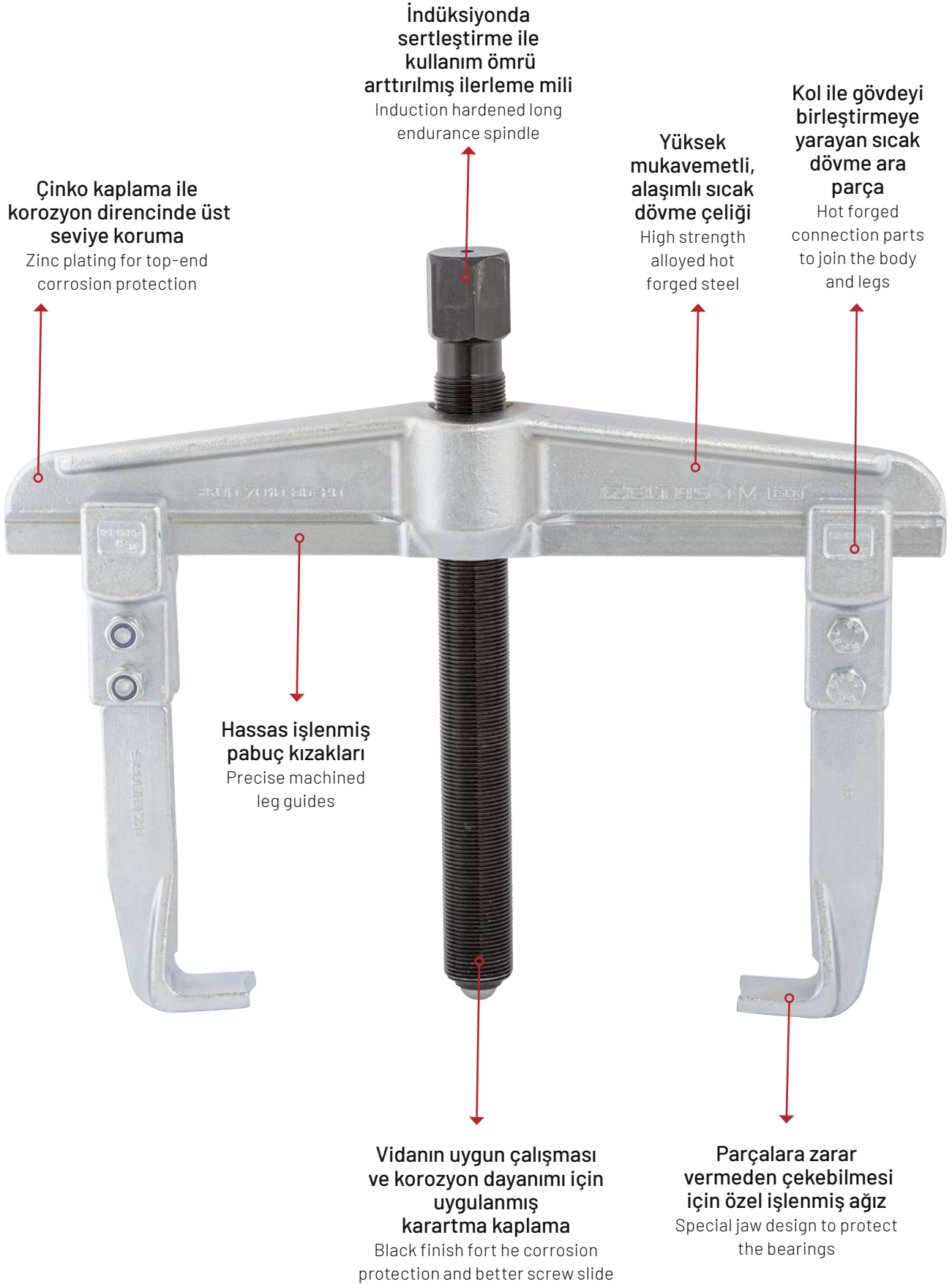

**STANDART ÇEKTİRME İKİ KOLLU / STANDARD PULLER TWO ARMS**

**7010**
**Standart Çektirme (İki Kollu)**  
 Standard Puller (Two Arms)

TSEK

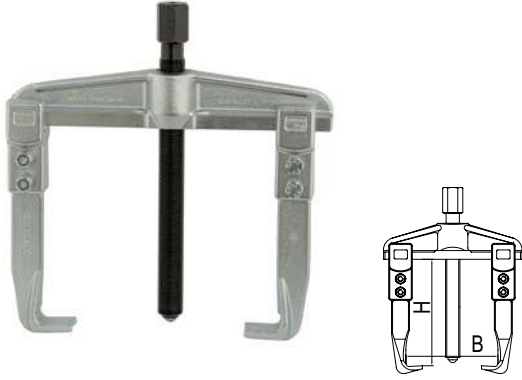
 Yedek parça sayfa 255-259  
 Spare parts page 255-259

**Krom vanadyum, Çinko kaplı, Kollar sertleştirilmiş,  
 Mil indüksiyonda sertleştirilmiş**  
 Chrom vanadium, Zinc plated,  
 Arms hardened, Spindle induction hardened

KOD CODE		B mm	H mm	g		TL/Ad.
7010 29 0810	8x10	80	100	1070	1	2.899,25
7010 29 1210	12x10	120	100	1235	1	3.100,00
7010 29 1615	16x15	160	150	2795	1	5.283,50
7010 29 2015	20x15	200	150	3000	1	5.778,75
7010 29 2520	25x20	250	200	7345	1	9.981,00
7010 29 3520	35x20	350	200	7000	1	12.122,00
7010 29 5220	52x20	520	200	13170	1	17.818,25

**7020**
**Standart Çektirme (Üç Kollu)**  
 Standart Puller (Three Arms)

TSEK

 Yedek parça sayfa 255-259  
 Spare parts page 255-259

**Krom vanadyum, Çinko kaplı, Kollar sertleştirilmiş,  
 Mil indüksiyonda sertleştirilmiş**  
 Chrom vanadium, Zinc plated,  
 Arms hardened, Spindle induction hardened

KOD CODE		B mm	H mm	g		TL/Ad.
7020 29 3720	37x20	370	200	14000	1	22.368,25
7020 29 5220	52x20	520	200	17920	1	30.834,75

**7010 00 6105**
**Standart Çektirme Sehpası (Dolu)**  
 Display Frame For Pullers

KOD CODE	İÇERİK CONTENTS	g		TL/Ad.
7010 00 6105	8x10 - 12x10 - 16x15 20x15 - 25x20	17840	5	28.120,75





**7030**

**Master Çektirme (iki Kollu)**  
Master Puller (Two Arms)



 **Yedek parça sayfa 255-259**  
*Spare parts page 255-259*  
Krom vanadyum, Çinko kaplı, Kollar sertleştirilmiş,  
Mil indüksiyonda sertleştirilmiş  
Chrom vanadium, Zinc plated,  
Arms hardened, Spindle induction hardened



KOD CODE		B mm	H mm	g		TL/Ad.
7030 29 0808	8x8	80	80	545	1	1.168,50
7030 29 1212	12x12	120	120	1060	1	2.407,75
7030 29 1616	16x16	160	160	1915	1	3.622,75
7030 29 2320	23x20	230	200	3240	1	4.925,00

**7040**

**Master Çektirme (Üç Kollu)**  
Master Puller (Three Arms)



 **Yedek parça sayfa 255-259**  
*Spare parts page 255-259*  
Krom vanadyum, Çinko kaplı, Kollar sertleştirilmiş,  
Mil indüksiyonda sertleştirilmiş  
Chrom vanadium, Zinc plated,  
Arms hardened, Spindle induction hardened



KOD CODE		B mm	H mm	g		TL/Ad.
7040 29 0808	8x8	80	80	680	1	2.236,75
7040 29 1212	12x12	120	120	1335	1	3.274,00
7040 29 1616	16x16	160	160	2395	1	4.813,00
7040 29 2320	23x20	230	200	4025	1	6.479,00

**7050**

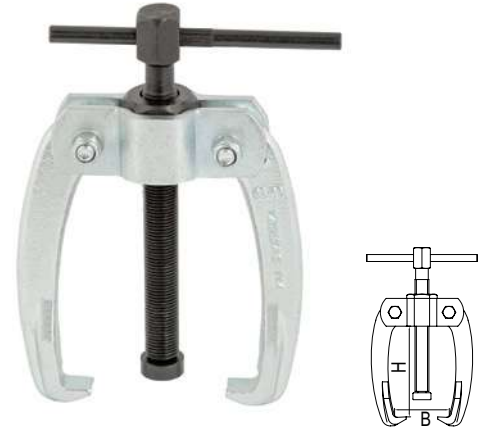
**Batarya Çektirme (iki Kollu)**  
Battery Puller (Two Arms)



 **Yedek parça sayfa 255-259**  
*Spare parts page 255-259*  
Krom vanadyum, Çinko kaplı, Kollar sertleştirilmiş,  
Mil indüksiyonda sertleştirilmiş  
Chrom vanadium, Zinc plated,  
Arms hardened, Spindle induction hardened



KOD CODE		B mm	H mm	g		TL/Ad.
7050 29 0604	6x4	60	40	240	1	1.299,75
7050 29 0606	6x6	60	60	290	1	1.340,75
7050 29 0808	8x8	80	80	605	1	1.408,00

**7060**

**Batarya Çektirme (Üç Kollu)**  
Battery Puller (Three Arms)



 **Yedek parça sayfa 255-259**  
*Spare parts page 255-259*  
Krom vanadyum, Çinko kaplı, Kollar sertleştirilmiş,  
Mil indüksiyonda sertleştirilmiş  
Chrom vanadium, Zinc plated,  
Arms hardened, Spindle induction hardened

KOD CODE		B mm	H mm	g		TL/Ad.
7060 29 0604	6x4	60	40	310	1	1.688,50
7060 29 0606	6x6	60	60	350	1	2.127,25
7060 29 0808	8x8	80	80	760	1	2.466,75

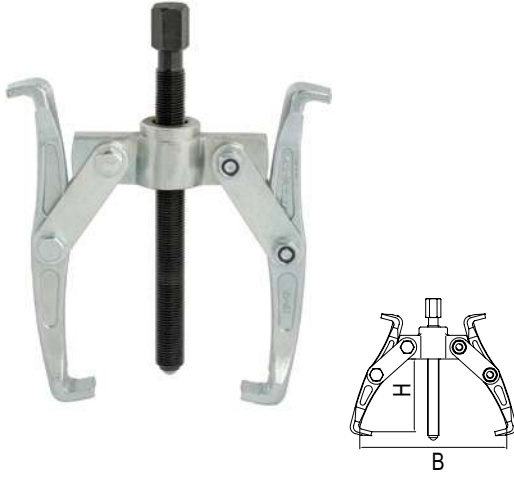
**7070 29 2013**
**S Tipi Çektirme (İki Kollu)**  
 S Type Puller (Two Arms)

**Yedek parça sayfa 255-259**  
*Spare parts page 255-259*  
**Krom vanadyum, Çinko kaplı, Kollarsertleştirilmiş,**  
**Mil indüksiyonda sertleştirilmiş**  
 Chrom vanadium, Zinc plated,  
 Arms hardened, Spindle induction hardened

KOD CODE		B mm	H mm	 g		TL/Ad.
7070 29 2013	20x13	200	130	2460	1	3.340,50

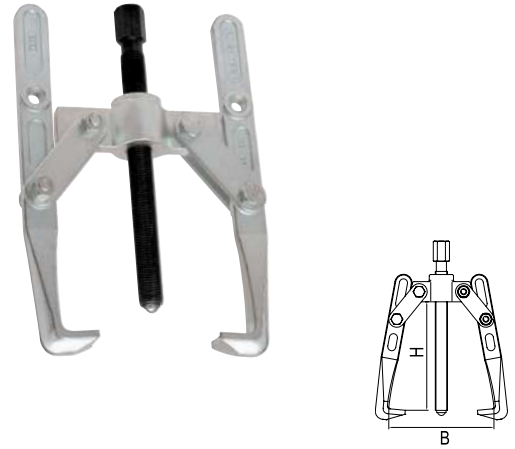
**7090 29 2222**
**Üniversal Çektirme (İki Kollu)**  
 Universal Puller (Two Arms)

**Yedek parça sayfa 255-259**  
*Spare parts page 255-259*  
**Krom vanadyum, Çinko kaplı, Kollar sertleştirilmiş,**  
**Mil indüksiyonda sertleştirilmiş**  
 Chrom vanadium, Zinc plated,  
 Arms hardened, Spindle induction hardened

KOD CODE		B mm	H mm	 g		TL/Ad.
7090 29 2222	22x22	220	220	3060	1	3.554,25

**7080 29 2013**
**S Tipi Çektirme (Üç Kollu)**  
 S Type Puller (Three Arms)

**Yedek parça sayfa 255-259**  
*Spare parts page 255-259*  
**Krom vanadyum, Çinko kaplı, Kollar sertleştirilmiş,**  
**Mil indüksiyonda sertleştirilmiş**  
 Chrom vanadium, Zinc plated,  
 Arms hardened, Spindle induction hardened

KOD CODE		B mm	H mm	 g		TL/Ad.
7080 29 2013	20x13	200	130	3260	1	4.307,00

**7100 29 2222**
**Üniversal Çektirme (Üç Kollu)**  
 Universal Puller (Three Arms)

**Yedek parça sayfa 255-259**  
*Spare parts page 255-259*  
**Krom vanadyum, Çinko kaplı, Kollar sertleştirilmiş,**  
**Mil indüksiyonda sertleştirilmiş**  
 Chrom vanadium, Zinc plated,  
 Arms hardened, Spindle induction hardened

KOD CODE		B mm	H mm	 g		TL/Ad.
7100 29 2222	22x22	220	220	4200	1	4.659,50

7120

**İç Rulman Çektirme Pensleri - Model A**  
Internal Expansion Puller - Model A

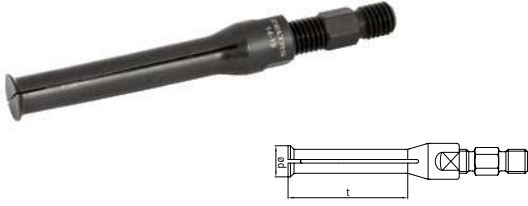

KOD CODE	σD mm	t mm	Kullanılan Kol / For	Adaptör vidası	g	TL/Ad.
7120 29 0507	5 - 7	30	35 - 75	M10	35	2.666,50
7120 29 0709	7 - 9	30	35 - 75	M10	40	2.666,50
7120 29 0912	9 - 12	30	35 - 75	M10	40	2.470,75
7120 29 1013	10 - 13	30	35 - 75	M10	40	2.470,75
7120 29 1317	13 - 17	50	35 - 75	M10	60	2.470,75
7120 29 1419	14 - 19	60	35 - 75	M10	95	2.531,00
7120 29 1621	16 - 21	60	35 - 75	M10	75	2.531,00
7120 29 1823	18 - 23	60	35 - 75	M10	95	3.029,00
7120 29 2025	20 - 25	60	35 - 75	M10	95	3.197,25
7120 29 2530	25 - 30	60	35 - 75	M10	105	3.331,25
7120 29 3037	30 - 37	70	35 - 75 60 - 130	M10	255	3.858,00
7120 29 3542	35 - 42	70	35 - 75 60 - 130	M10	265	4.055,00
7120 29 3845	38 - 45	70	35 - 75 60 - 130	M10	270	4.275,00
7120 29 4350	43 - 50	70	35 - 75 60 - 130	M10	315	4.860,75

7120 29 2540

**İç Rulman Çektirme Pensleri - Model B**  
Internal Expansion Puller - Model B



KOD CODE	σD mm	t mm	Kullanılan Kol / For	Adaptör vidası	g	TL/Ad.
7120 29 2540	25 - 40	45	35 - 75 60 - 130	M10	230	5.397,00

7120

**İç Rulman Çektirme Kolları**  
Arms For Internal Expansion Puller



**Krom vanadyum, Çinko kaplı, Kollar sertleştirilmiş,  
Mil indüksiyonda sertleştirilmiş**  
Chrom vanadium, Zinc plated,  
Arms hardened, Spindle induction hardened

KOD CODE	Kapasite Capacity mm	Kullanılan pensler / For	Adaptör vidası Screw Adapter	g	TL/Ad.
----------	----------------------	--------------------------	------------------------------	---	--------

7120 29 3575	35 - 75	Model A 5 - 7'den 43 - 50'ye Model B 25 - 40	M10	630	1 2.715,50
--------------	---------	--	-----	-----	------------

7120 29 6013	60 - 130	Model A 30 - 37'den 43 - 50'ye Model B 25 - 40	M10	1580	1 5.501,00
--------------	----------	--	-----	------	------------



7122

 Dış Rulman Çektirme Çeneleri  
 Separator

Krom vanadyum, Çinko kaplı, Kollar sertleştirilmiş,  
 Mil indüksiyonda sertleştirilmiş  
 Chrom vanadium, Zinc plated,  
 Arms hardened, Spindle induction hardened

KOD CODE	Ø mm	Kullanılan Kollar / For	Adaptör vidası	g	TL/Ad.
7122 29 0560	5 - 60	40 - 115	M12	430	1 4.122,00
7122 29 1275	12 - 75	40 - 115	M12	650	1 5.163,25
7122 29 2211	22 - 115	55 - 205	M16	1950	1 8.060,50
7122 29 2515	25 - 155	90 - 260	M20x1.5	3845	1 12.618,75
7122 29 3022	30 - 220	100 - 360	M20x1.5	9425	1 34.480,50
7122 29 4028	40 - 280	140 - 435	M24x3	23000	1 77.010,50

7122

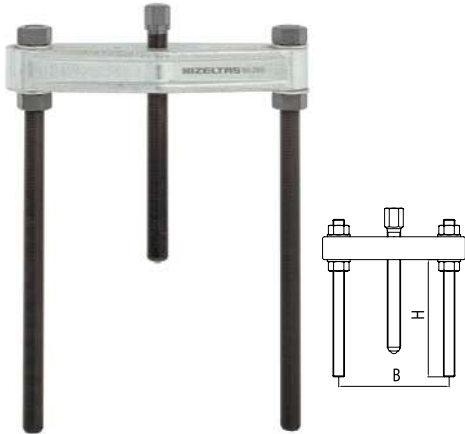
 Dış Rulman Çektirme Kolları  
 Puller Arms For Separator

Krom vanadyum, Çinko kaplı, Mil indüksiyonda sertleştirilmiş  
 Chrom vanadium, Zinc plated,  
 Arms Spindle induction hardened

KOD CODE	B mm	H mm	Kullanılan Çene / For	Adaptör vidası	g	TL/Ad.
7122 29 4011	40-115	150	5 - 60 12 - 75	M12	990	1 7.680,25
7122 29 5520	55-205	210	22 - 115	M16	2770	1 12.156,25
7122 29 9026	90-260	315	25 - 155	M20x1.5	4900	1 17.211,00
7122 29 1036	100-360	305	30 - 220	M20x1.5	8900	1 35.416,50
7122 29 1443	140-435	320	40 - 280	M24x3	19200	1 69.219,75

7126

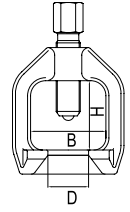
 Rotil Çektirme  
 Extractor For Ball Joint

KOD CODE	øD mm	B mm	H mm	g	TL/Ad.
7126 29 0018	18	40	40	305	1 2.312,00
7126 29 0025	25	50	50	525	1 3.168,50
7126 29 0029	29	60	60	890	1 4.215,00
7126 29 0040	40	80	80	1885	1 5.948,25
7126 29 0045	45	90	100	2785	1 7.510,50





- Anahtarlar  
Wrenches
- Lokma Anahtarları  
Sockets Wrenches
- Boru Anahtarları ve Penseler  
Pipe Wrenches and Pliers
- Tornavida ve Allen Anahtarlar  
Screwdrivers and Hex Key Wrenches
- Keskiler  
Chisels
- Genel El Aletleri  
General Hand Tools
- Makaslar  
Shears
- Maket Bıçakları  
Utility Knives



0150

## İki Ağız Anahtar (mm) Double Ended Open Jaw Wrench (mm)



TS 81  
DIN 895

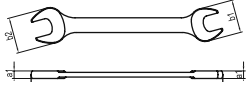

Krom vanadyum, Krom kaplı  
Chrom vanadium, Chrom plated

0150

## İki Ağız Anahtar Takımı (mm) Double Ended Open Jaw Wrench Set (mm)



KOD CODE	mm	L mm	a1 mm	b1 mm	b2 mm	g	□	TL/Ad.
0150 01 0607	6x7	98	3.3	13.5	15.5	15	10	89,00
0150 01 0809	8x9	108	3.6	17.5	19.5	20	10	90,50
0150 01 1011	10x11	120	4.1	21.5	23.5	30	10	98,75
0150 01 1213	12x13	134	4.5	25.5	27.5	440	10	108,50
0150 01 1415	14x15	150	5	29.5	31.5	60	10	126,00
0150 01 1617	16x17	163	5.5	33.5	35.5	80	10	145,25
0150 01 1819	18x19	178	6	37.5	39.5	105	10	155,00
0150 01 2022	20x22	198	6.5	41.5	45.5	150	10	176,75
0150 01 2123	21x23	218	6.9	43.5	47.5	170	10	191,75
0150 01 2426	24x26	236	7.4	49.5	53.5	230	10	220,50
0150 01 2528	25x28	250	7.8	51.5	57.5	270	10	264,25
0150 01 2732	27x32	265	8.3	55.5	65.5	355	10	314,75

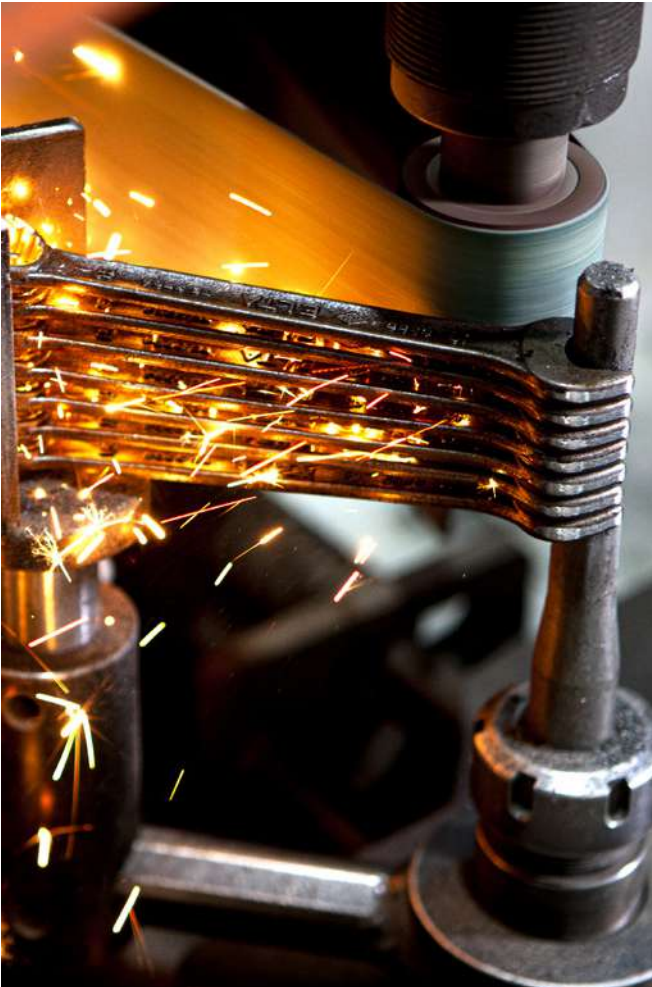

KOD CODE	İÇERİK CONTENTS	g	□	TL/Ad.
0150 00 2108	6x7 - 8x9 - 10x11 12x13 - 14x15 - 16x17 18x19 - 20x22	560	8	989,75
0150 00 2112	6x7 - 8x9 - 10x11 12x13 - 14x15 - 16x17 18x19 - 20x22 - 21x23 24x26 - 25x28 - 27x32	1590	12	1.981,00

## 0350

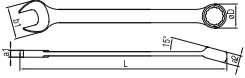
Kombine Anahtar (mm)  
Combination Wrench (mm)TS 3794  
TS ISO 7738 Form A  
DIN 3113Krom vanadyum, Krom kaplı  
Chrom vanadium, Chrom plated

## 0350

Kombine Anahtar Takımı (mm)  
Combination Wrench Set (mm)

KOD CODE	mm	L mm	a1 mm	a2 mm	b1 mm	øD mm	g	TL/ Ad.
0350 02 0006	6	95	3.1	5.1	13.5	10	10	116,50
0350 02 0007	7	104	3.3	5.5	15.5	11.5	15	123,25
0350 02 0008	8	112	3.7	5.9	17.5	13	20	133,00
0350 02 0009	9	121	3.9	6.3	19.5	14	25	137,00
0350 02 0010	10	130	4.3	6.9	21.5	15.5	30	155,00
0350 02 0011	11	138	4.5	7.3	23.5	16.5	35	160,25
0350 02 0012	12	146	4.9	7.7	25.5	18	45	170,00
0350 02 0013	13	154	5.1	8.1	27.5	19	50	172,50
0350 02 0014	14	163	5.5	8.7	29.5	21.5	60	186,25
0350 02 0015	15	171	5.7	9.1	31.5	22	70	198,50
0350 02 0016	16	180	6.1	9.5	33.5	23	85	213,50
0350 02 0017	17	189	6.3	9.9	35.5	25	90	228,75
0350 02 0018	18	200	6.7	10.4	37.5	26.5	110	253,25
0350 02 0019	19	211	6.9	11	39.5	28	125	267,00
0350 02 0020	20	222	7.3	11.4	41.5	29.5	140	272,50
0350 02 0021	21	235	7.3	11.4	43.5	31	160	314,75
0350 02 0022	22	250	8.1	12.6	45.5	32.5	195	360,00
0350 02 0024	24	270	8.7	13.6	49.5	36	245	440,75
0350 02 0027	27	300	9.6	14.8	55.5	40	335	517,50
0350 02 0030	30	330	10.2	15.8	61.5	44.5	430	594,00
0350 02 0032	32	350	10.4	16.2	65.5	47	485	622,50



KOD CODE	İÇERİK CONTENTS	g	TL/ Ad.	
0350 00 2108	6 - 7 - 8 - 9 - 10 - 13 17 - 19	395	8	1.333,00
0350 00 2112	8 - 9 - 10 - 11 - 12 13 - 14 - 15 - 16 17 - 19 - 22	855	12	2.381,75
0350 00 2117	6 - 7 - 8 - 9 - 10 11 - 12 - 13 - 14 15 - 16 - 17 - 18 19 - 20 - 21 - 22	1300	17	3.462,00
0350 00 2121	6 - 7 - 8 - 9 - 10 11 - 12 - 13 - 14 15 - 16 - 17 - 18 19 - 20 - 21 - 22 24 - 27 - 30 - 32	2810	21	5.636,75

## 0450

Yıldız İki Ağız Anahtar (mm)  
Double Ended Ring Wrench (mm)

TS 3794  
TS ISO 10104 Form B  
DIN 838

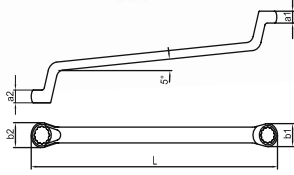

Krom vanadyum, Krom kaplı  
Chrom vanadium, Chrom plated

KOD CODE	mm	L mm	a1 mm	a2 mm	b1 mm	b2 mm	g		TL/Ad.
0450 03 0607	6x7	140	4.8	5.2	11	12	30	10	198,50
0450 03 0809	8x9	158	5.4	5.8	13.5	14.5	45	10	201,25
0450 03 1011	10x11	175	6	6.4	16	17.5	60	10	223,25
0450 03 1213	12x13	193	6.6	7.1	19	20	80	10	252,00
0450 03 1415	14x15	210	7.7	8.1	21.5	23.5	110	10	264,25
0450 03 1617	16x17	230	9.2	9.6	25.5	26.5	150	10	300,00
0450 03 1819	18x19	246	10.2	10.6	27.5	29.5	185	10	357,25
0450 03 2022	20x22	280	11.2	11.8	31	34	265	5	390,00
0450 03 2123	21x23	284	11.4	12.2	32.5	35	315	5	447,50
0450 03 2426	24x26	300	12.6	13.2	37	39	395	5	521,50
0450 03 2528	25x28	314	13.6	14.2	38	42	455	5	570,75
0450 03 2732	27x32	329	14.8	15.2	41	49	565	5	628,25

## 0450

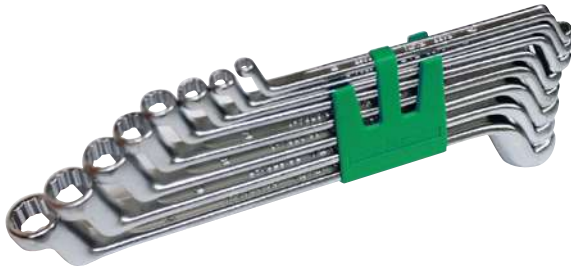
Yıldız İki Ağız Anahtar Takımı (mm)  
Double Ended Ring Wrench Set (mm)

KOD CODE	İÇERİK CONTENTS	g		TL/Ad.
0450 00 2108	6x7 - 8x9 - 10x11 12x13 - 14x15 - 16x17 18x19 - 20x22	1120	8	2.186,50
0450 00 2112	6x7 - 8x9 - 10x11 12x13 - 14x15 - 16x17 18x19 - 20x22 - 21x23 24x26 - 25x28 - 27x32	2710	12	4.354,50

## 0601

Kurbağacık Anahtar  
Adjustable Wrench

TS ISO 6787

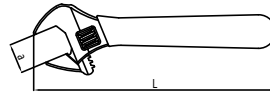

Özel alaşımlı çelik, Krom kaplı, PVC izoleli  
Special steel, Chrom plated, PVC Insulated

KOD CODE	L mm	L inch	a mm	g		TL/Ad.
0601 01 0008	206	8"	24	265	5	683,00
0601 01 0010	256	10"	27	400	5	1.026,00
0601 01 0012	306	12"	34	650	5	1.355,75

14000 005078

1/4" Cırcir Lokma Anahtar & Bits Set (38 parça, mm)  
Socket Wrench & Bits Set (38 Pcs, mm)



1/4"



KOD CODE	LOKMALAR Sockets	AVADANLIKLAR Accessories	g		TL/Ad.
14000 005078	5 - 5.5 - 6 - 7 - 8 9 - 10 - 11 - 12 13 - 14 Altı Köşe Lokma Anahtar Six Points	1/4" Cırcir kolu Ratchet Handle 1/4" Mafsal Universal Joint 1/4" Ara Kol Extension Bar 50 -100 mm 1/4" Derin Lokma Tornavida Adaptörü Spindle Handle SL3 - SL4 - SL5 SL6 PH1 - PH2 - PH3 PH4 PZ1 - PZ2 - PZ3 H3 - H4 - H5 - H6 T10 - T15 - T20 T25 - T27 - T30 T40	790	38	3.852,50

14000 005080

Adaptörlü Bits Uç Set (71 Parça)  
Bits Set (71 Pcs)



KOD CODE	AVADANLIKLAR Accessories	g		TL/Ad.
14000 005080	Universal Bits Adaptörü Universal Bits Adapter Hızlı Değişirme Bits Adaptörü Quick Change Bits Adapter SL4 - SL6 (75 mm) SL4 - SL6 (25 mm) PH1 - PH2 - PH3 (75 mm) PH1 - PH2 - PH3 (25 mm) PZ1 - PZ2 (75 mm) PZ1 - PZ2 - PZ3 (25 mm) H2 - H2.5 - H3 - H4 - H5 H8 (25 mm) T20 - T25 (75mm) T10 - T15 - T20 - T25 - T27 T30 - T40 (25mm)	750	71	3.531,00

14000 005079

1/4" Cırcir Lokma Anahtar & Bits Set (23 parça, mm)  
Socket Wrench & Bits Set (23 Pcs, mm)



1/4"



KOD CODE	LOKMALAR Sockets	AVADANLIKLAR Accessories	g		TL/Ad.
14000 005079	5 - 6 - 7 - 8 10 - 12 - 13 Altı Köşe Lokma Anahtar Six Points	1/4" Bits / Lokma Tutucu Cırcir Kolu 1/4" Ara Kol Extension Bar 50 mm Hızlı Değişirme Bits Adaptörü SL4 - SL6 PH1 - PH2 H4 - H5 - H6 T15 - T20 - T25 T27 - T30 - T40	430	23	3.852,50

Havali aletler ile kullanmayınız / Do not use with power-tools

1115

### 1/2" Altı Köşe Lokma Anahtar (mm) Socket Wrench 6 Points (mm)

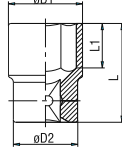
TS ISO 2725-1  
DIN 3124

1/2"

Krom vanadyum, Krom kaplı  
Chrom vanadium, Chrom plated

KOD CODE	mm	ø D1 mm	ø D2 mm	L mm	L1 mm	g	TL/ Ad.
1115 06 0010	10	15.4	22	38	8	50	10 146,50
1115 06 0011	11	16.6	22	38	8	50	10 146,50
1115 06 0012	12	17.9	22	38	9	50	10 146,50
1115 06 0013	13	19	22	38	10	50	10 152,00
1115 06 0014	14	20.4	22	38	11	55	10 152,00
1115 06 0015	15	21.6	22	38	11	55	10 152,00
1115 06 0016	16	22.9	22	38	11	60	10 157,50
1115 06 0017	17	24.1	22	38	12	600	10 157,50
1115 06 0018	18	25.4	23	38	13	70	10 157,50
1115 06 0019	19	26.6	23	38	13	70	10 170,00
1115 06 0021	21	29.2	24	38	13	80	5 170,00
1115 06 0022	22	30.4	26	38	15	95	5 170,00
1115 06 0023	23	31.2	28	38	15	100	5 184,75
1115 06 0024	24	33	28	38	17	115	5 184,75
1115 06 0026	26	34	30	42	17	130	5 206,75
1115 06 0027	27	36.6	30	42	19	155	5 235,50
1115 06 0028	28	37.5	30	42	20	140	5 247,75
1115 06 0030	30	40	32	44	21	190	5 247,75
1115 06 0032	32	43	34	44	23	220	5 265,75

1514 06 6250

### 1/2" T Kol Adaptörü Adapter



1/2"

Krom vanadyum, Krom kaplı  
Chrom vanadium, Chrom plated

KOD CODE	inch	g	TL/ Ad.
1514 06 6250	3/8"Fx1/2"M	75	5 320,50

Havali aletler ile kullanmayınız / Do not use with power-tools

1514

### 1/2" Ara Kol Extension Bar

TS ISO 1174-1  
TS ISO 3316  
DIN 3123

1/2"

Krom vanadyum, Krom kaplı  
Chrom vanadium, Chrom plated

KOD CODE	L mm	g	TL/ Ad.
1514 06 4125	125	220	5 293,00
1514 06 4250	250	425	5 507,75

1514 06 4065

### 1/2" Mafsal Universal Joint

TS ISO 1174-1  
TS ISO 3316  
DIN 3123

1/2"

Krom vanadyum, Krom kaplı  
Chrom vanadium, Chrom plated

KOD CODE	L mm	g	TL/ Ad.
1514 06 4065	65	150	5 390,00

1514 06 5250

### 1/2" Cırcır Kolu (32 Diş) Ratchet Handle (32 Teeth)

TS ISO 3315  
DIN 3122

1/2"

Krom vanadyum, Krom kaplı  
Chrom vanadium, Chrom plated

KOD CODE	L mm	g	TL/ Ad.
1514 06 5250	250	540	5 1.187,75

1115 00 2017

1/2" Altı Köşe Lokma Anahtar Takımı (17 Parça, mm)

Socket Wrench Set 6 Points (17 pcs, mm)



1/2"

KOD CODE	LOKMALAR Sockets	AVADANLIKLAR Accessories	g	TL/Ad.
1115 00 2017		1/2" Cırcır Kolu Ratchet Handle	2485	17
	10 - 11 - 12 13 - 14 - 15 17 - 19 - 22 24 - 27 - 30 32	1/2" T Kol Adaptör Sliding T Handle Adapter		
		1/2" Mafsal Universal Joint		
		1/2" Ara Kol Extension Bar 250 mm		
				4.732,75

1115 00 2024

1/2" Altı Köşe Lokma Anahtar Takımı (24 Parça, mm)

Socket Wrench Set 6 Points (24 pcs, mm)



1/2"

KOD CODE	LOKMALAR Sockets	AVADANLIKLAR Accessories	g	TL/Ad.
1115 00 2024		1/2" Cırcır Kolu Ratchet Handle	4335	24
		1/2" Mafsal Universal Joint		
	10 - 11 - 12 13 - 14 - 15 16 - 17 - 18 19 - 21 - 22 23 - 24 - 26 27 - 28 - 30 - 32	1/2" T Kol Adaptör Sliding T Handle Adapter		
		1/2" Ara Kol Extension Bar 125 mm		
		1/2" Ara Kol Extension Bar 250 mm		
				6.150,00



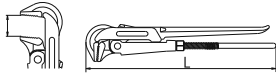

2203

### Maşalı Boru Anahtarı (85°) Pipe Wrench (85°)

TS 3796  
DIN 5234



Krom vanadyum, Dişler induksiyonda sertleştirilmiş, Elektrostatik boyanmış  
Chrom vanadium, Teeth induction hardened, Electrostatically painted

KOD CODE	L mm	 mm	 inch	 g		TL/Ad.
2203 10 0010	325	40	1"	800	1	1.168,50
2203 10 0015	430	60	1 1/2"	1405	1	1.834,75
2203 10 0020	585	70	2"	2450	1	2.733,50

2401 11 0240

### Fort Pense Waterpump Pliers

TS 60  
TS ISO 8976  
DIN 8976



2509 11 0225

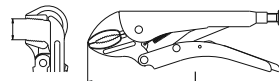
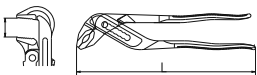

### Ayarlı Pense Grip



Nikel kaplı, PVC izoleli  
Nickel plated, PVC Insulated

Nikel kaplama, Kullanım sahası: Yuvarlak ve düz malzemeler  
Nickel plated, Application field: Flat and round materials

KOD CODE	L mm	L inch	 mm	 g		TL/ Ad.
2401 11 0240	240	9 1/2"	35	385	5	1.104,25

KOD CODE	L mm	L inch	 mm	 g		TL/ Ad.
2509 11 0225	225	9"	30	475	5	1.064,50

3021

**Kombine Pense Opak Seri**  
Combination Pliers

TS 60  
DIN ISO 5746



Özel alaşımli çelik, Kesici ağızlar indüksiyonda sertleştirilmiş, PVC saplı  
Special steel, Cutters induction hardened, PVC handle

KOD CODE	L mm	L inch	g	□	TL/Ad.
3021 12 1160	160	6 1/4"	200	5	570,75
3021 12 1180	180	7 1/8"	260	5	699,25
3021 12 1200	200	8"	320	5	851,25

3221

**Kargaburun Düz Uçlu Opak Seri**  
Long Nose Pliers (Flat)

TS 60  
TS ISO 5745



Özel alaşımli çelik, Kesici ağızlar indüksiyonda sertleştirilmiş, PVC saplı  
Special steel, Cutters induction hardened, PVC handle

KOD CODE	L mm	L inch	g	□	TL/Ad.
3221 13 1160	160	6 1/4"	145	5	620,00
3221 13 1200	200	8"	200	5	710,25

3701

**Yan Keski Opak Seri**  
Side Cutting Pliers

TS 60  
TS ISO 5749  
DIN 5749



Özel alaşımli çelik, Kesici ağızlar indüksiyonda sertleştirilmiş, PVC saplı  
Special steel, Cutters induction hardened, PVC handle

KOD CODE	L mm	L inch	g	□	TL/Ad.
3701 16 1140	140	5 1/2"	150	5	543,25
3701 16 1160	160	6 1/4"	205	5	637,75

3801

**Kerpeten**  
Carpenter Pincers

TS 60  
TS ISO 9243  
DIN ISO 9243



Özel alaşımli çelik, Kesici ağızlar indüksiyonda sertleştirilmiş, Vernikli, PVC izoleli  
Special steel, Cutters induction hardened, Lacquered, PVC Insulated

KOD CODE	L mm	L inch	g	□	TL/Ad.
3801 15 0160	160	6 1/4"	250	5	621,50
3801 15 0180	180	7 1/8"	255	5	670,50
3801 15 0200	200	8"	335	5	837,50

3832

**Betoncu Kerpeteni**  
Tower Pincers

TS 60  
TS ISO 9242  
DIN ISO 9242



Özel alaşımli çelik, Kesici ağızlar indüksiyonda sertleştirilmiş, Vernikli, PVC izoleli  
Special steel, Cutters induction hardened, Lacquered, PVC insulated

KOD CODE	L mm	L inch	g	□	TL/Ad.
3832 15 0225	225	9"	355	5	799,25
3832 15 0250	250	10"	395	5	909,75
3832 15 0280	280	11"	400	5	1.092,00

4170 17 0680

**Değişken Uçlu Tornavida**  
Screwdriver - Reversible

TSEK

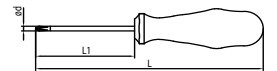

Krom vanadyum, Krom kaplı, PP saplı  
Chrom vanadium, Chrom plated, PP handle



KOD CODE	øDxL1 mm	axb mm	+	L mm	g	□	TL/Ad.
4170 17 0680	6x80	1.2x6	Ph2	180	65	10	234,00

4150

### Opak Seri Düz Uçlu Tornavida Screwdriver, Opak, Flat



TS ISO 2380 - 1  
DIN ISO 2380-1

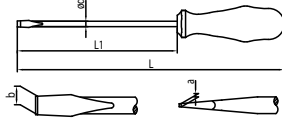

Krom vanadyum, Krom kaplı, PP saplı  
Chrom vanadium, Chrom plated, PP handle

KOD CODE	σDxL1 mm	-		L mm	g	□	TL/Ad.
		a mm	b mm				
4150 17 0380	3x80	0.5	3	150	20	10	102,75
4150 17 0480	4x80	0.8	4	170	35	10	117,75
4150 17 4100	4x100	0.8	4	190	35	10	126,00
4150 17 5100	5x100	1.0	5.5	200	55	10	150,50
4150 17 5125	5x125	1.0	5.5	225	60	10	174,00
4150 17 6100	6x100	1.2	6.5	200	65	10	157,50
4150 17 6125	6x125	1.2	6.5	225	70	10	178,00
4150 17 6150	6x150	1.2	6.5	250	75	10	197,25
4150 17 7150	7x150	1.2	8	260	100	10	230,00
4150 17 8175	8x175	1.6	10	285	130	10	278,00

4170

### Opak Seri Yıldız Uçlu Tornavida Screwdriver, Opak Phillips



TS 59 - 5 ISO 8764  
DIN ISO 8764

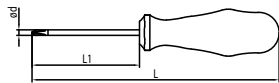

Krom vanadyum, Krom kaplı, PP saplı  
Chrom vanadium, Chrom plated, PP handle

KOD CODE	σDxL1 mm	+	L mm	g	□	TL/Ad.
4170 18 4580	4.5x80	Ph1	170	40	10	155,00
4170 18 6100	6x100	Ph2	200	65	10	186,25
4170 18 8150	8x150	Ph3	260	120	10	350,50

4150 00 8106

### Opak Seri Tornavida Seti (6 parça) Screwdriver Set, Opak (6 Pcs)



KOD CODE	İÇERİK CONTENTS	g	□	TL/Ad.
4150 00 8106	4x80 - 5x100 - 6x125	510	6	1.017,50
	7x150			
	Düz uçlu / Flat 4.5x80 - 6x100 Yıldız uçlu / Phillips			

4150 00 8107

### Opak Seri Tornavida Seti (7 parça) Screwdriver Set, Opak (7 Pcs)



KOD CODE	İÇERİK CONTENTS	g	□	TL/Ad.
4150 00 8107	3x80 - 4x100 - 5x125	575	7	1.219,25
	6x150 - 8x175			
	Düz uçlu / Flat 4.5x80 - 6x100 Yıldız uçlu / Phillips			

★ Stoklarla Sınırlıdır / It is Limited by Stocks.

## 4908

Allen Anahtar Altı Köşe Standart Boy (mm)  
Hex Key Wrench Standard Size (mm)TS ISO 2936  
DIN ISO 2936Krom vanadyum, Siyah Oksit Kaplı  
Chrom vanadium, Black finish

KOD CODE	mm	L mm	L1 mm	g	TL/Ad.
4908 22 0015	1.5	45	14	5	15,25
4908 22 0020	2	50	16	5	19,50
4908 22 0025	2.5	56	18	5	22,00
4908 22 0030	3	63	20	5	25,00
4908 22 0035	3.5	66	22	5	29,00
4908 22 0040	4	70	25	10	33,25
4908 22 0050	5	80	28	15	34,25
4908 22 0060	6	90	32	30	46,75
4908 22 0070	7	95	36	40	66,00
4908 22 0080	8	100	36	55	75,25
4908 22 0090	9	105	38	75	107,00
4908 22 0100	10	112	40	100	115,25
4908 22 0120	12	125	45	160	167,25

## 4908

Allen Anahtar Takım Altı Köşe Standart Boy (mm)  
Hex Key Wrench Set Standard Size (mm)

KOD CODE	İÇERİK CONTENTS	g	TL/Ad.
4908 00 3107	1.5 - 2 - 2.5 - 3 - 4 - 5 - 6	85	196,00
4908 00 3109	1.5 - 2 - 2.5 - 3 - 4 - 5 - 6 - 8 - 10	255	386,50
4908 00 3110	1.5 - 2 - 2.5 - 3 - 4 - 5 - 6 - 8 - 10 - 12	420	553,75

## 4922

T Tipi Allen Anahtar (mm)  
Hex Key Wrench T - Handle (mm)Krom vanadyum, Siyah Oksit Kaplı, PP saplı  
Chrom vanadium, Black finish, PP handle

KOD CODE	mm	L mm	L1 mm	g	TL/Ad.	
4922 22 0025	2.5	110	14	15	5	187,75
4922 22 0030	3	125	18	20	5	187,75
4922 22 0040	4	140	22	30	5	190,50
4922 22 0050	5	155	26	55	5	215,00
4922 22 0060	6	170	30	75	5	235,50
4922 22 0070	7	185	34	115	5	243,75
4922 22 0080	8	200	38	150	5	294,25
4922 22 0100	10	220	48	265	5	512,00

## 4922 00 8108

T Tipi Allen Anahtar Takımı (8 Parça, mm)  
Hex Key Wrench T - Handle Set (8 Pcs, mm)

KOD CODE	İÇERİK CONTENTS	g	TL/Ad.	
4922 00 8108	2.5 - 3 - 4 - 5 6 - 7 - 8 - 10	795	8	2.066,50

4915 00 6106

Kaset Allen Anahtar Takımı (6 Parça, mm)  
Hex Key Wrench Folding Set (6 Pcs, mm)



Krom vanadyum, Siyah oksid kaplı  
Chrom vanadium, Black finish

KOD CODE	İÇERİK CONTENTS	g	TL/ Ad.
4915 00 6106	2.5 - 3 - 4 - 5 - 6 - 8	165	1 914,00

5011

Iskarpela (Düz)  
Wood Chisel

TS 531

YENİ TASARIM  
NEW DESIGN

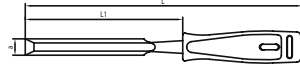

Özel alaşımlı çelik, Uç indüksiyonda sertleştirilmiş, PP Saplı  
Special steel, induction hardened tips, PP Handle

KOD CODE	a mm	L mm	L1 mm	g	TL/ Ad.
5011 23 0006	6	240	120	100	5 345,00
5011 23 0008	8	242	122	110	5 367,00
5011 23 0010	10	244	124	110	5 387,50
5011 23 0012	12	246	126	125	5 424,25
5011 23 0014	14	248	128	130	5 439,25
5011 23 0016	16	250	130	135	5 469,50
5011 23 0018	18	252	132	140	5 509,25
5011 23 0020	20	254	134	150	5 563,75
5011 23 0022	22	256	136	165	5 613,25
5011 23 0024	24	258	138	175	5 661,00
5011 23 0026	26	260	140	185	5 685,50
5011 23 0030	30	264	144	205	5 732,00

5801

Tesviyeci Çekiç  
Machinist Hammer

TS 5-1  
DIN 1041



Özel alaşımlı çelik, İndüksiyonda sertleştirilmiş, Elektrostatik boyanmış  
Special steel, Induction hardened, Electrostatically painted

KOD CODE	L mm	L1 mm	g	g	TL/ Ad.
5801 25 0500	320	118	500	600	5 354,00
5801 25 1000	360	135	1000	1095	5 570,50
5801 25 1500	380	145	1500	1630	5 688,50
5801 25 2000	400	155	2000	2100	5 786,75

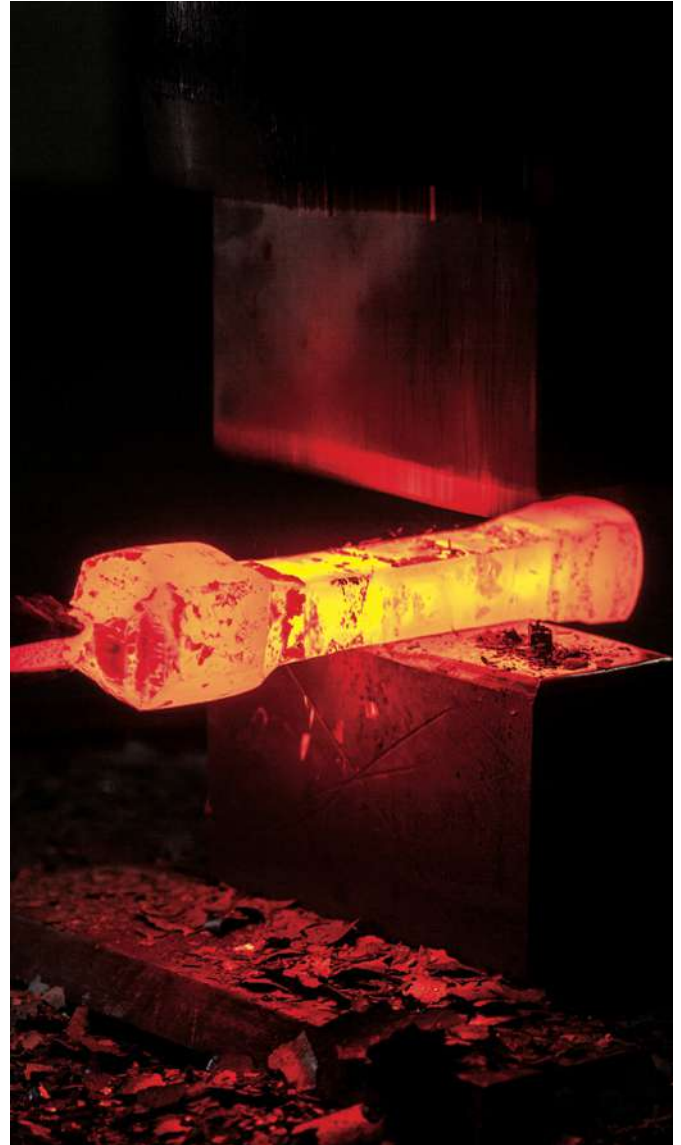

5884

### Plastik Şerit Metre

Plastic Measuring tapes



### Plastik Şerit Metre

Plastic Measuring tapes



KOD CODE	ÖLÇÜ SIZE	g	TL/Ad.
★ 5884 26 0003	3	95	157,50

KOD CODE	ÖLÇÜ SIZE	g	TL/Ad.
14000 005370	3	95	155,25
14000 005369	5	195	223,50

14000 005508

### Makaralı Uzatma Kablosu 5m (El Tipi)

Extension Cord Reel 5m (With Handle)

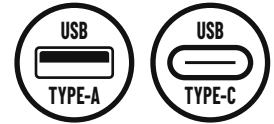

#### TEKNİK ÖZELLİKLER / TECHNICAL DATA

Nominal Gerilim / Nominal Voltage	230V- 50/60Hz
Akım / Current	Max. 16A
Kablo Sarılı Halde Maks. Güç / Load Reeled	1000W
Kablo Açılmış Halde Maks. Güç / Extended Max.	2300W
Soket Tipi / Socket Type	4x2 P + E
Soket Standardı / Socket Standart	Schuko (F-type)
Kablo / Cable	Max. ø 3x1mm
Giriş Koruması / Ingress Protection	IP44-IP20

KOD CODE	MODEL	ÖLÇÜ SIZE	g	TL/Ad.
14000 005508	El Tipi / With Handle	5	830	1.282,50

★ Stoklarla Sınırlıdır / It is Limited by Stocks.

14000 006046

165mm Multi Tool Plus (13 Fonksiyonlu)  
165mm Multi Tool Plus (13 Functions)multi tool PLUS<sup>+</sup>YENİ  
NEW

**33mm Bits:**  
PH1+PH2,PH0+SL2.5,  
SL4+SL6,T10+T15

Paslanmaz çelik  
Stainless steelKargaburun  
Needle-nose PliersDüz Pense  
PliersTel Kesici  
Wire CutterBits Tutucu  
Bits AdapterTığ/İplik İğnesi  
Awı/Thread NeedleCetvel  
RulerTestere  
SawEge  
FileØ3 Düz Tornavida/  
Konserve Açacağı/  
Ø3 Flat Screwdriver/  
Can OpenerØ5 Düz Tornavida/  
Şişe Açacağı  
Ø5 Flat Screwdriver/  
Bottle OpenerTestere Dişli Bıçak  
Serrated KnifeBıçak  
Knife33mm Bits Uçlar  
33mm BitsKOD  
CODE

14000 006046

L  
mm

165

g

327

1

1

TL/Ad.

1.668,25

14000 006047

160mm Multi Tool Compact (12 Fonksiyonlu)  
160mm Multi Tool Compact (12 Functions)

multi tool Compact

YENİ  
NEW



Kargaburun  
Needle-nose Pliers



Düz Pense  
Pliers



Tel Kesici  
Wire Cutter



Bıçak  
Knife



Çengelli Çıkarıcı/  
Cetvel  
Hooked Remover/Ruler



Kazıma Bıçağı  
Scraping Knife



Yıldız Tornavida  
Phillips Screwdriver



Ø2,5 Düz  
Tornavida  
Ø2,5 Flat  
Screwdriver



Ø4 Düz  
Tornavida  
Ø4 Flat  
Screwdriver



Ø5 Düz  
Tornavida/Eğme  
Ø5 Flat  
Screwdriver/File



Konserve Açacağı  
Can Opener



Şişe Açacağı  
Bottle Opener



Paslanmaz çelik, alüminyum sap  
Stainless steel, aluminum handle

KOD CODE	L mm	g	1	TL/Ad.
14000 006047	160	238	1	1.076,50

14000 006048

75mm Multi Tool Mini (7 Fonksiyonlu)

75mm Multi Tool Mini (7 Functions)

**multi tool mini****YENİ  
NEW**Kargaburun  
Needle-nose PliersDüz Pense  
PliersTel Kesici  
Wire CutterØ2 Düz Tornavida/  
Kazıma Bıçağı  
Ø2 Flat Screwdriver/  
Scraping KnifeYıldız Tornavida  
Phillips ScrewdriverKüçük Bıçak  
Small KnifeEge  
FilePaslanmaz çelik  
Stainless steel

KOD CODE	L mm	g	1	TL/Ad.
14000 006048	75	48	1	453,25

13000 005654

Hobby Set (4 Parça)  
Hobby Set (4 Pcs)YENİ  
NEW

KOD CODE	İÇERİK CONTENTS	☐	TL/Ad.
3021 12 1160	Kombine Pense Opak Seri Combination Pliers 160mm	1	1.221,25
14000 005044	Ergonomik Kilitli Maket Bıçağı Ergonomic Safety Utility Knife 18mm	1	
14000 005369	Plastik Şerit Metre Plastic Measuring Tape 5m	1	
4170 17 0680	Değişken Uçlu Tornavida Screwdriver - Reversible (6x80)	1	

13000 005652

Pense Seti (3 Parça)  
Pliers Set (3 Pcs)YENİ  
NEW

KOD CODE	İÇERİK CONTENTS	☐	TL/Ad.
3021 12 1160	Kombine Pense Opak Seri Combination Pliers 160mm	1	1.957,00
3701 16 1160	Yan Keski Opak Seri Side Cutting Pliers 160mm	1	
3221 13 1160	Kargaburun Düz Uçlu Opak Seri Long Nose Pliers (Flat) 160mm	1	

13000 005656

Pense Seti (2 Parça)  
Pliers Set (2 Pcs)YENİ  
NEW

KOD CODE	İÇERİK CONTENTS	☐	TL/Ad.
3021 12 1160	Kombine Pense Opak Seri Combination Pliers 160mm	1	1.208,50
3701 16 1160	Yan Keski Opak Seri Side Cutting Pliers 160mm	1	

5891 26 0830

Testere Kolu  
Hacksaw Frame

DIN 6473



KOD CODE	L mm	g	TL/Ad.
5891 26 0830	300	330	558,50

6731 27 0650

Çim Kesme Makası (Eğri Ağız)  
Grass Shears (Wave Edges)

KOD CODE	L mm	L inch	g	TL/Ad.
6731 27 0650	650	25 5/8"	1230	1.740,25

6351

Levye Oluklu  
Tyre Lever, Straight

TSEK

Krom vanadyum, Krom kaplı  
Chrom vanadium, Chrom plated

KOD CODE	L mm	L inch	g	TL/Ad.
6351 26 0400	400	16"	435	431,00
6351 26 0500	500	20"	665	630,75
6351 26 0600	600	24"	940	821,00

6730 27 0550

Çim Kesme Makası (Düz Ağız)  
Grass Shears (Straight)

KOD CODE	L mm	L inch	g	TL/Ad.
6730 27 0550	550	21 5/8"	835	974,25

6721 27 0205

**Bağ Makası (Lüks)**  
Pruning Shears (Lux)



Özel alaşımlı çelik, Kesici ağızlar indüksiyonda sertleştirilmiş, Daldırma PVC izoleli Special steel, Cutters induction hardened, PVC dipped

KOD CODE	L mm	L inch	g	TL/Ad.
6721 27 0205	205	8"	280	5 737,75

6722 27 0220

**Bağ Makası (Hafif Tip)**  
Pruning Shears (Light)



Alüminyum gövde, Daldırma PVC izoleli  
Aluminum forged body, PVC dipped

KOD CODE	L mm	L inch	g	TL/Ad.
6722 27 0220	220	8 5/8"	220	5 1.063,25

8011 31 6001

**Teşhir Panosu**  
Display



★ El aletleri görsel amaçlıdır, teşhir panosu boş olarak satılmaktadır.  
The hand tools are for illustrative purposes only; the display board is sold empty.

KOD CODE	SIZE mm	Cinsi	g	TL/Ad.
8011 31 6001	500x1000x2250	Boş	14000	1 12.311,00



14000 005043

Metal Gövdeli Kilitli Maket Bıçağı 18mm  
Metal-Bodied Safety Utility Knife 18mm



 Yedek parça sayfa 255-259  
Spare parts page 255-259

- Otomatik Kilit Mekanizması / Auto-Lock Mechanism
- Metal + ABS Plastik Gövde / Metal-ABS Plastic Bodied
- Ergonomik Yapı / Ergonomic Design
- 18 mm Bıçak Genişliği / 18 mm Blade Width
- Bıçak Kırma Yeri / Knife Breaking Part
- Askı Delikli / Hanging Hole

KOD/CODE	L mm	 g		TL/Ad.
14000 005043	158	125	12	290,25



14000 005044

Ergonomik Kilitli Maket Bıçağı 18mm  
Ergonomic Safety Utility Knife 18mm



 Yedek parça sayfa 255-259  
Spare parts page 255-259

- Otomatik Kilit Mekanizması / Auto-Lock Mechanism
- ABS Plastik Gövde / ABS Plastic Bodied
- Kauçuk Kavramalı / Rubber Coated
- Ergonomik Yapı / Ergonomic Design
- 18 mm Bıçak Genişliği / 18 mm Blade Width
- Bıçak Kırma Yeri / Knife Breaking Part
- Askı Delikli / Hanging Hole

KOD/CODE	L mm	 g		TL/Ad.
14000 005044	172	105	12	193,00



14000 005045

Ergonomik Kilitli Maket Bıçağı 9mm  
Ergonomic Safety Utility Knife 9mm



 Yedek parça sayfa 255-259  
Spare parts page 255-259

- Otomatik Kilit Mekanizması / Auto-Lock Mechanism
- ABS Plastik Gövde / ABS Plastic Bodied
- Kauçuk Kavramalı / Rubber Coated
- Ergonomik Yapı / Ergonomic Design
- 9 mm Bıçak Genişliği / 9 mm Blade Width
- Bıçak Kırma Yeri / Knife Breaking Part
- Askı Delikli / Hanging Hole

KOD/CODE	L mm	 g		TL/Ad.
14000 005045	140	145	12	113,75



14000 005046

Ergonomik Kilitli Maket Bıçağı Set 18mm - 9mm  
Ergonomic Safety Utility Knife Set 18mm - 9mm



 Yedek parça sayfa 255-259  
Spare parts page 255-259

- Otomatik Kilit Mekanizması / Auto-Lock Mechanism
- ABS Plastik Gövde / ABS Plastic Bodied
- Kauçuk Kavramalı / Rubber Coated
- Ergonomik Yapı / Ergonomic Design
- 9-18 mm Bıçak Genişliği / 9-18 mm Blade Width
- Bıçak Kırma Yeri / Knife Breaking Part
- Askı Delikli / Hanging Hole

KOD/CODE	L mm	 g		TL/Ad.
14000 005044	172	145	12	306,75
14000 005045	140	145	12	306,75

# YEDEK PARÇALAR

SPARE PARTS





## 0600

**Kurbağacak Anahtar ve Ayarlı Montaj Anahtarları Yedek Parçaları**  
 Adjustable Wrench, Spare Parts

	KOD CODE	L mm	L inch	g	TL/ Ad.
<b>Somun Nut</b> 	0600 01 0206	160	6"	10	60,50
	0600 01 0208	208	8"	70	71,25
	0600 01 0210	260	10"	10	94,75
	0600 01 0212	308	12"	15	130,00
	0600 01 0215	388	15"	20	186,25
<b>Vida Bolt</b> 	0600 01 0306	160	6"	5	16,75
	0600 01 0308	208	8"	5	25,00
	0600 01 0310	260	10"	5	30,25
	0600 01 0312	308	12"	5	38,50
	0600 01 0315	388	15"	15	48,00
	<b>Yay Spring</b> 	0600 01 0406	160	6"	5
0600 01 0408		208	8"	5	12,75
0600 01 0410		260	10"	5	12,75
0600 01 0412		308	12"	5	12,75
0600 01 0415		388	15"	5	12,75

## 2100

**Stilson Anahtar Yedek Parçaları**  
 Stillson Wrench Spare Part

	KOD CODE	ÖLÇÜ FOR	g	TL/ Ad.
<b>Çene Jaw</b> 	2100 10 0108	8"	100	418,75
	2100 10 0110	10"	190	620,00
	2100 10 0112	12"	320	691,00
	2100 10 0114	14"	400	833,50
	2100 10 0118	18"	575	1.120,75
	2100 10 0124	24"	975	1.603,50
	<b>Bağlantı Parçası Connection Part</b> 	2100 10 0208	8"	60
2100 10 0210		10"	95	952,25
2100 10 0212		12"	135	1.042,75
2100 10 0214		14"	200	1.257,50
2100 10 0218		18"	345	1.442,25
2100 10 0224		24"	475	2.154,75
<b>Somun Nut</b> 	2100 10 0308	8"	10	310,75
	2100 10 0310	10"	20	343,50
	2100 10 0312	12"	25	358,75
	2100 10 0314	14"	40	399,75
	2100 10 0318	18"	65	551,50
	2100 10 0324	24"	105	603,50

**Zincirli Boru Anahtarı Yedek Zinciri**  
 Spare Chain For Chain Pipe Wrench

KOD CODE	ÖLÇÜ SIZE Inch	L mm	g	TL/ Ad.
14000 005039	4"	555	840	1 2.761,00
14000 005038	6"	785	1635	1 4.815,50
14000 005139	8"	990	2400	1 5.617,25

## 2110

**Ağır Tip Boru Anahtarı Yedek Parçaları**  
 Pipe Wrench, Heavy Duty Spare Parts

	KOD CODE	ÖLÇÜ FOR	g	TL/ Ad.	
<b>Çene Jaw</b> 	2110 10 0108	8"	105	923,50	
	2110 10 0110	10"	210	1.123,25	
	2110 10 0112	12"	315	2.215,25	
	2110 10 0114	14"	395	2.361,25	
	2110 10 0118	18"	685	2.509,25	
	2110 10 0124	24"	970	3.762,00	
	2110 10 0136	36"	1600	7.521,50	
	2110 10 0148	48"	3295	12.387,25	
	<b>Somun Nut</b> 	2110 10 0308	8"	10	305,25
		2110 10 0310	10"	25	320,50
2110 10 0312		12"	35	349,00	
2110 10 0314		14"	35	423,00	
2110 10 0318		18"	65	562,50	
2110 10 0324		24"	110	856,50	
2110 10 0336		36"	220	1.588,50	
2110 10 0348		48"	305	2.546,00	

**Alt Çene ve Pim**  
 Lower Jaw  
 and Pin

2110 10 0408	8"	15	5	972,75
2110 10 0410	10"	35	5	1.078,25
2110 10 0412	12"	60	5	1.215,00
2110 10 0414	14"	60	5	1.253,25
2110 10 0418	18"	90	5	1.298,50
2110 10 0424	24"	115	5	1.428,50
2110 10 0436	36"	230	5	2.276,75
2110 10 0448	48"	285	5	3.072,75

## 2201

**Maşalı Boru Anahtarı Yedek Somun**  
 Nut

KOD CODE	ÖLÇÜ FOR	g	TL/ Ad.
2201 10 0110	1"	20	72,75
2201 10 0115	1 1/2"	35	92,00
2201 10 0120	2"	55	120,75
2201 10 0130	3"	75	161,75
2201 10 0140	4"	75	189,00

## 2350

**Demir Kesme Makası Yedek**  
 Bolt Cutters Spare Part

**Çene  
Jaw**

KOD CODE	ÖLÇÜ SIZE	KAPASİTE CAPACITY ø mm	g	TL/ Ad.
2350 27 0118	18"	6 - 8	695	1 1.576,25
2350 27 0124	24"	8 - 10	1110	1 1.806,00
2350 27 0130	30"	9 - 13	1230	1 3.194,50
2350 27 0136	36"	11 - 16	2050	1 5.897,75

**5850**
**Plastik Çekiç Yedek Başlık**  
 Plastic Hammer Spare Head

KOD CODE	ØD mm	g	TL/Ad.
5850 25 0130	30	35	10 150,50
5850 25 0140	40	65	10 213,50
5850 25 0150	50	120	10 305,25

**6400**
**Keser Yedek Sapı**  
 Adze Handle

KOD CODE	L mm	g	TL/Ad.
6400 25 0001	400	205	10 194,50

**5800**
**Tesviyeci Çekiç Yedek Sapı (Kamalı)**  
 Hammer Handle (With Pin)

KOD CODE	L mm	g	g	TL/Ad.
5800 25 0001	260	100	65	10 155,00
5800 25 0002	280	200	70	10 155,00
5800 25 0003	300	300	95	10 174,00
5800 25 0005	320	500	120	10 194,50
5800 25 0010	360	1000	180	10 252,00
5800 25 0015	380	1500	185	10 283,50
5800 25 0020	400	2000	235	10 305,25

**5865**
**Madırğa Yedek Sapı (Kamalı)**  
 Mallet Handle (With Pin)

KOD CODE	L mm	g	TL/Ad.
5865 25 0001	260	1000	10 182,25
5865 25 0002	280	1500	10 200,00

**6410**
**Nacak Yedek Sap (Kamalı)**  
 Hatchet Handle (With Pin)

KOD CODE	L mm	g	g	TL/Ad.
6410 25 0001	380	800	250	10 584,25

**03755**
**Kablo Sıyırıcı Yedek Bıçağı**  
 Cable Strippers Spare Blade

KOD CODE	ÖLÇÜ SIZE	g	TL/Ad.
03755 50 625	ø 4-16 / ø 8-28	5	5 213,50

**06375**
**Ayarlı Yağ Filtresi Sökeceği Yedek Kelepçe**  
 Adjustable Slot Type Oil Filter Wrench Spare Clamp

KOD CODE	Ø mm	g	TL/Ad.
06375 50 010	65	220	5 174,00



6230

Gres Pompası Yedek Ucu  
Grease Gun Nozzle



500cc  
300cc

KOD CODE	L mm	Ø mm	g	TL/Ad.	
6230 26 2500	38	15	30	10	138,25

Hortumu  
Hose for  
Grease Gun



KOD CODE	Ø mm	cc	g	TL/Ad.	
6230 26 3300	8	300	35	10	157,50
6230 26 3500	12	500	100	10	288,75

05898

HSS Testere Laması  
Hacksaw Blade HSS



KOD CODE	ÖLÇÜ SIZE	g	TL/Ad.	
05898 50 283	13x0.65x18	20	100	148,00

05899

Bimetal Testere Laması  
Hacksaw Blade Bimetal



KOD CODE	ÖLÇÜ SIZE	g	TL/Ad.	
05899 50 283	13x0.65x18	20	100	172,50

6735

Dal Budama Testeresi Yedek Bıçak  
Spare Blade for Pruning Saw



KOD CODE	L mm	g	TL/Ad.	
6735 27 1300	300	65	5	1.287,50

06765

Plastik Boru Kesme Makası Bıçağı  
Plastic Pipe Cutter Spare Blade



KOD CODE	ÖLÇÜ SIZE	g	TL/Ad.	
06765 50 042	42	85	5	2.044,25
06765 50 063	63	145	5	3.795,25

6850

Mini Boru Kesici Bıçağı / Blade For Mini Tube Cutter  
Standart Boru Kesici Bıçağı / Blade For Standard Tube Cutter  
Teleskopik Boru Kesici Bıçağı / Blade For Telescopic Tube Cutter



KOD CODE	ÖLÇÜ SIZE	g	TL/Ad.	
6850 28 1322	1/4" - 13/8"	5	10	230,00

6865

Profesyonel Boru Kesici Bıçağı  
Blade For Professional Tube Cutter



KOD CODE	ÖLÇÜ SIZE	g	TL/Ad.	
6865 28 0150	1/8" - 2"	25	5	475,00

14000 005090

Pro Güvenlikli Trapez Maket Bıçağı Yedek Bıçak 18 mm  
Pro Safety Utility Knife Spare Blade 18 mm



KOD CODE	ÖLÇÜ / SIZE (mm)	TL/Ad.	
14000 005090	18	10	123,25

14000 005088

Pro Maket Bıçağı Yedek Bıçak 18 mm  
Pro Utility Knife Spare Blade 18 mm



KOD CODE	ÖLÇÜ / SIZE (mm)	TL/Ad.	
14000 005088	18	10	97,25

14000 005089

Pro Maket Bıçağı Yedek Bıçak 9 mm  
Pro Utility Knife Spare Blade 9 mm



KOD CODE	ÖLÇÜ / SIZE (mm)	TL/Ad.	
14000 005089	9	10	61,75

14000 005091

Pro Maket Bıçağı Yedek Bıçak 30° Açılı 9 mm  
Pro Utility Knife Spare Blade 30° 9 mm



KOD CODE	ÖLÇÜ / SIZE (mm)	TL/Ad.	
14000 005091	9	10	61,75

**7010-7020**
**Standart Çektirme Yedek Parçaları**  
 Spare Parts For Standard Pullers

**Uzatma Parçası / Connection Part, Extension**

KOD CODE	L mm	KULLANILAN ÇEKTİRME FOR	g	TL/Ad.
7010 29 2033	200	8x10 - 12x10	170	696,75
7010 29 3033	300	16x15 - 20x15	335	1.212,25
7010 29 4033	400	25x20 - 35x20 37x20 - 52x20	2350	1.792,25

**Kol / Arm**

KOD CODE	L mm	KULLANILAN ÇEKTİRME FOR	g	TL/Ad.
7010 29 0822	8x10 - 12x10		105	525,75
7010 29 1622	16x15 - 20x15		345	912,75
7010 29 2522	25x20 - 35x20 52x20 - 37x20		750	1.596,75

**Bağlantı Parçası / Connection Part**

KOD CODE	L mm	KULLANILAN ÇEKTİRME FOR	g	TL/Ad.
7010 29 0833	8x10 - 12x10		155	265,75
7010 29 1633	16x15 - 20x15		325	457,25
7010 29 2533	25x20 - 35x20 52x20 - 37x20		930	800,50

**Mil / Spindle**

KOD CODE	L mm	KULLANILAN ÇEKTİRME FOR	g	TL/Ad.
7010 29 0844	8x10 - 12x10		185	480,25
7010 29 1644	16x15 - 20x15		560	915,50
7010 29 2544	25x20		1380	1.573,25
7010 29 3544	35x20 - 37x20		2187	2.051,00
7010 29 5244	52x20		3175	2.051,00

**7030-7040**
**Master Çektirme Yedek Parçaları/Spare Parts For Master Puller**
**Kol / Arm**

KOD CODE	KULLANILAN ÇEKTİRME FOR	g	TL/Ad.
7030 29 0822	8x8	110	287,50
7030 29 1222	12x12	210	398,25
7030 29 1622	16x16	340	710,25
7030 29 2322	23x20	570	966,00

**Mil/Spindle**

KOD CODE	L mm	KULLANILAN ÇEKTİRME FOR	g	TL/Ad.
7030 29 0844	8x8		185	390,00
7030 29 1244	12x12		355	573,50
7030 29 1644	16x16		675	633,75
7030 29 2344	23x20		1335	867,75

**7050-7060**
**Batarya Çektirme Yedek Parçaları**  
 Spare Parts For Battery Pullers

**Kol / Arm**

KOD CODE	KULLANILAN ÇEKTİRME FOR	g	TL/Ad.
7050 29 0422	6x4	40	224,75
7050 29 0622	6x6	50	250,75
7050 29 0822	8x8	100	287,50

**Mil / Spindle**

KOD CODE	L mm	KULLANILAN ÇEKTİRME FOR	g	TL/Ad.
7050 29 0444	6x4		95	332,75
7050 29 0644	6x6		105	372,25
7050 29 0844	8x8		210	468,00

**7070-7080**
**S Tipi Çektirme Yedek Parçaları**  
 Spare Parts For S Type Puller

**Kol / Arm**

KOD CODE	KULLANILAN ÇEKTİRME FOR	g	TL/Ad.
7070 29 2022	20x13	410	574,75

**Mil / Spindle**

KOD CODE	L mm	KULLANILAN ÇEKTİRME FOR	g	TL/Ad.
7070 29 2044	20x13		560	800,50

**7090-7100**
**Üniversal Çektirme Yedek Parçaları**  
 Spare Parts For Universal Puller

**Kol / Arm**

KOD CODE	KULLANILAN ÇEKTİRME FOR	g	TL/Ad.
7090 29 2322	22x22	715	639,00

**Mil / Spindle**

KOD CODE	L mm	KULLANILAN ÇEKTİRME FOR	g	TL/Ad.
7090 29 2244	22x22		570	842,75





**IZELTAS®**

# TİCARİ TEŞHİR ÜRÜNLERİ

COMMERCIAL DISPLAY PRODUCTS



1113 31 6100

### 1/2" Lokma Anahtar Sehpaası

Display Frame for Sockets



1/2"

Sacdan imal edilmiş, Fırın boya  
Made of sheet metal, Electrostatic paint

KOD CODE	ÖLÇÜ SIZE mm	g	TL/Ad.
1113 31 6100	175x360x605	5800	3.721,00

7010 31 6105

### Çektirme Sehpaası

Display Frame For Pullers



Sacdan imal edilmiş, Fırın boya  
Made of sheet metal, Electrostatic paint

KOD CODE	İÇERİK CONTENTS	g	TL/Ad.
7010 31 6105	Boş - Empty	2125	1.078,25

2350 31 6104

### Demir Kesme Makası Sehpaası

Display Frame for Bolt Cutters

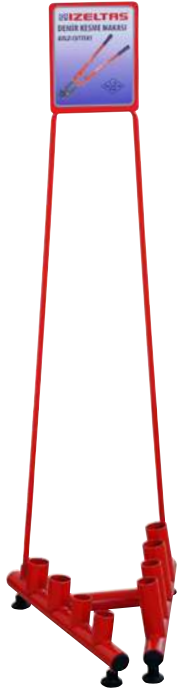

Fırın boya  
Electrostatic paint

KOD CODE	İÇERİK CONTENTS	g	TL/Ad.
2350 31 6104	Boş - Empty	7040	5.130,00

7300 31 6150

### İşkence Sehpaası

Display Frame for Screw Clamps



Fırın boya  
Electrostatic paint

KOD CODE	ÖLÇÜ SIZE mm	g	TL/Ad.
7300 31 6150	100x520x1420	10000	4.409,25

**8001-8002**
**Çatal ve Yıldız Anahtar Sehpası**  
 Display Frame For Wrenches

Sacdan imal edilmiş, Fırın boya  
 Made from metal sheet, Electrostatic paint

KOD CODE	ÖLÇÜ SIZE mm	g	İÇERİK CONTENTS	TL/Ad.
8001 31 6012	160x500	1090	Çatal / Open Jaw	1 573,50
8002 31 6012	170x560	1080	Yıldız / Ring	1 715,75

**8004 31 6004**
**Dövme Çelik Mengene Sehpası**  
 Forged Steel Vice Frame

Fırın boya  
 Electrostatic paint

KOD CODE	İÇERİK CONTENTS	g	TL/Ad.
8004 31 6004	Boş - Empty	8000	1 5.466,75

**8015 31 6001**
**Tekerlekli Üçgen Teşhir Standı**  
 Triangular Display Frame

Sacdan imal edilmiş, Fırın boya  
 Made from metal sheet, Electrostatic paint

KOD CODE	ÖLÇÜ SIZE mm	g	TL/Ad.
8015 31 6001	520x1670	29500	1 7.751,25



## 8010 Teşhir Panosu / Display Panel

İzeltaş El Aletleri Teşhir Panosu, satış noktaları için özel olarak dizayn edilmiştir. Kolayca monte edilebilen 19 ana parçadan oluşan panonun derinliği 46 cm, genişliği 100 cm, yüksekliği 220 cm'dir.

Etkili görünümü ve tüm ürünleri bir arada sergileme özelliği yanında, perakende satışlarda seçme kolaylığı sağlaması bakımından da önem taşımaktadır.

İzeltaş's Product Display Panel has been specially designed for points of sale. These boards are made from easily mountable 19 main parts and have the dimensions as following, width 46 cm, length 100 cm and height 220 cm.

Board features an impressive look and displays the products all together, which makes it easy to choose desired tools during retail selling activities.

### Montaj Sırası / Montage Order

1. Ayak / Stand right leg
2. Plastik ayak / Plastic leg
3. Kolon / Stand right column
4. Ayak / Stand left leg
5. Plastik ayak / Plastic leg
6. Kolon / Stand left column
7. Raf / Shelf
8. Delikli pano / Drilled panel
9. Delikli pano / Drilled panel
10. Delikli pano / Drilled panel
11. Delikli pano / Drilled panel
12. Yarım delikli pano / Half - drilled panel
13. Aydınlatma alınlığı / Illumination panel
14. Yan kapak / Side cover
15. Yan kapak / Side cover
16. Ön kapak / Front cover
17. Tornavida askısı / Screwdriver hanger
18. Büyük askı / Long hanger
19. Küçük askı / Short hanger

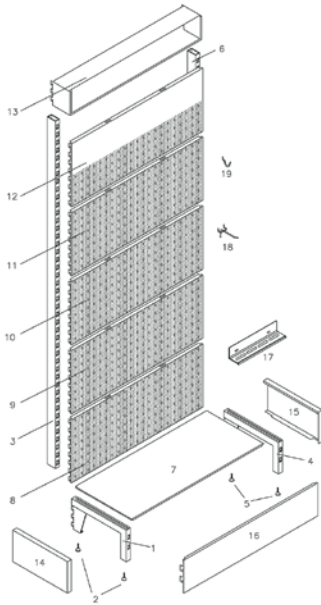

### Büyük Pano Display Panel (Empty)

KOD CODE	ÖLÇÜ SIZE mm	CİNSİ TYPE	g	TL/Ad.	
8010 31 6001	460x1000x2200	Boş/Empty	38000	1	14.874,50

**IZELTAS®**

# TEKNİK BİLGİLER

TECHNICAL INFORMATION

---





**Elektrik akımı geçme (1000V üzeri hariç) ihtimali olan tüm yerlerde IEC 60900'a göre izoleli uygun el aletleri kullanılmalıdır.**  
Hand tools with IEC 60900 compliant isolation must be used for any work involving risk of electrical current (excluding 1000V and above).



**Tozlu ve çapaklı alanlarda mutlaka gözlük kullanınız.**  
Make sure to wear goggles in work areas with dust and burrs.



**Lokma anahtarlarınızı uygun ölçülerdeki cıvata, en geniş yüzeyde dik olarak kullanınız. Lokma anahtarların cıvataya eğik olarak takılıp kullanılması, kavrama yüzeyini azaltarak ürünün kullanım ömrünü kısaltacaktır.**  
Use box wrenches with bolts of appropriate size, placed perpendicularly on the largest area of contact. Use of a box wrench at an angle will reduce the gripping surface and result in a shorter useful life.



**Yüksek sesli ortamlarda mutlaka kulaklık kullanınız.**  
Make sure to wear ear protection in work areas with high levels of noise.



**Çekici amacı dışında kendinden daha sert malzemelere vurmuyunuz, eğik olarak kullanmayınız. Mantarlaşmış bölgeleri mutlaka temizleyerek kullanınız.**  
Do not use a hammer outside its intended purpose or to hit objects harder than the hammer. Do not hit at an angle. Make sure to clean weakened parts before use.



**Kimyasal madde içeren işlerde mutlaka eldiven ve maske kullanınız.**  
Make sure to wear gloves and facemask for works involving chemical materials.

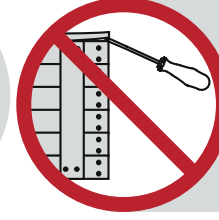

**Tornavidayı amacı dışında sökme işlemlerinde kullanmayınız.**  
Do not use the screwdriver as a levering tool out of its intended purpose.



**Anahtarlarınızı, ağız ölçüsüne uygun cıvatalarda kullanınız. Anahtar ve cıvata arasındaki ölçü uyumsuzluğu, üründe ağız aşınmasına neden olur.**  
Use wrenches with bolts of appropriate size. Size discrepancy between wrench and bolt will lead to wear on tool edge.

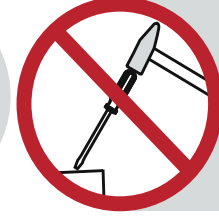

**Tornavidayı amacı dışında keski gibi ya da darbeli olarak kullanmayınız.**  
Do not use the screwdriver as a chiselling tool or for impacting out of its intended purpose.



**Anahtarların ağızına taşlama işlemi yapmayınız; sert cisimler sürterek müdahale etmeyiniz. Bu durum anahtarınızın ağız yapısını bozar.**  
Do not grind or expose the edge of wrenches to hard objects. This will deform the tool edge structure.



**Dolapları çekerek değil iterek kullanınız.**  
Do not pull the set cabinets. Push to move the cabinets.



**Anahtar gövdesine boru takarak kuvvet uygulamayınız. Anahtarınızın ağız yapısının bozulmasına, kırılmalara ve yaralanmalara neden olabilir.**  
Do not apply force to the wrench by attaching a pipe to the tool body. This may result in deformation of tool edge, breakage or injury.

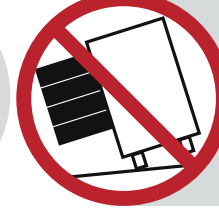

**Dolapların birden fazla çekmecelerini aynı anda açık bırakmayınız. Ağırlık merkezi değişerek dolabın devrilmesine neden olacaktır.**  
Do not leave multiple drawers of set cabinets open at the same time. This will move the centre of gravity and cause toppling.



**Anahtar gövdesine çekiç ile darbe uygulamayınız. Ağız yapısında bozulmalara, kırılma ve yaralanmalara neden olabilir.**  
Do not hit the wrench body with a hammer. This may result in deformation of tool edge, breakage or injury.



**Dolapların çekmecelerini ayağınızla kapatmaya ya da basamak, merdiven olarak kullanmaya çalışmayınız. Bu gibi durumlar yaralanmalara sebep olacaktır.**  
Do not use your foot to close a cabinet drawer or attempt to use cabinet drawers as a stepladder. Such actions will result in injury.

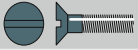

**VİDA AĞIZ ÖLÇÜLERİ****GUIDELINE FOR SCREWDRIVERS**

											
"Metrik Vida Metric screw"	<b>M 1.6</b> <b>(M 1.7)</b>	<b>M 2</b>	<b>M 2.3</b>	<b>(M 2.3)</b> <b>(M 2.6)</b>	<b>M 3</b>	<b>(M 3.5)</b>	<b>M 4</b>	<b>M 5</b>	<b>M 6</b>	<b>M 8</b>	<b>M 10</b>
Düz başlı Vidalar Flat head screws	0.4 x 3 (3.2)	0.5 x 3.8	0.6 x 4.4	0.6 x 4.5 (5)	0.8 x 5.5	0.8 x 6	1 x 7	1.2 x 8.5	1.6 x 10	2 x 13	2.5 x 16
Düz başlı Vidalar Flat head screws	—	—	—	—	0.8 x 6	0.8 x 7	1 x 8	1.2 x 10	1.6 x 12	2 x 16	2.5 x 20
Düz başlı Vidalar (küçük) Flat head screws (small sizes)	—	—	—	0.4 x 3.5	0.5 x 4	0.5 x 4.5	0.6 x 5.5	0.8 x 6.5	1 x 8	1.2 x 10	1.6 x 13
Oval başlı Vidalar Oval head screws	0.4 x 3	0.5 x 3.8	—	0.6 x 4.7	0.8 x 5.6	—	—	—	—	—	—
Havşa başlı Vidalar Countersank head screws	0.4 x 3	0.5 x 3.8	—	0.6 x 4.7	0.8 x 5.6	0.8 x 6.5	1 x 7.5	1.2 x 9.2	1.6 x 11	2 x 14.5	2.5 x 18

**YILDIZ VİDALAR İÇİN UYGUN TORNAVİDA AĞIZ ÖLÇÜLERİ****SUITABLE TIPS FOR CROSS HEAD SCREWS**

		
Yıldız Ağız Ölçüsü Cross Slot Size		<b>Metrik Vidalar</b> <b>Metric Screw</b>
0		M 1.6 - M 2
1		M 2 - M 2.5 - M 3
2		M 3.5 - M 5
3		M 6
4		M 8 - M 10



**TEKNİK BİLGİLER / TECHNICAL DATA**
**METRİK VİDALAR İÇİN LOKMA SEÇİMİ**

 GUIDE TO METRIC SIZES COVERED BY SOCKET  
 WRENCHES FOR EACH DRIVE

**LOKMLAR İÇİN MİN DÖNDÜRME MOMENTLERİ**

 TEST TORQUE VALUES FOR SOCKET  
 ISO 1711-1(N-m)

	1107 6.3	1110 10	1113 12.5	1119 20	1125 25		
	1/4"	3/8"	1/2"	3/4"	1"		
M 2	4						
	4,5						
M 2.5	5						
M 3	5,5						
M 3.5	6	6					
M 4	7	7					
M 5	8	8	8				
	9	9	9				
M 6	10	10	10	10			
M 7	11	11	11	11			
	12	12	12	12			
M 8	13	13	13	13			
		14	14	14			
		15	15	15			
M 10		16	16	16			
M 10		17	17	17	17		
M 12		18	18	18	18		
M 12		19	19	19	19		
		20	20				
M 14		21	21	21	21		
M 14		22	22	22	22	22	22
		23	23	23			
M 16			24	24	24	24	24
			25				
			26				
M 18			27	27	27	27	27
			28				
M 20			30	30	30	30	30
M 22			32	32	32	32	32
			33	33	33	33	33
M 22			34	34	34	34	34
M 24				36	36	36	36
				38	38	38	38
M 27				41	41	41	41
					42		
M 30				46	46	46	46
M 33				50	50		
M 36				55	55		
M 39				60	60		
M 42					65		
M 45					70		
M 48					75		
M 52							

		6,3 1107	10 1110	12,5 1113 1114	20 1119 1120	25 1125
		1/4"	3/8"	1/2"	3/4"	1"
M2	4	10,4				
M 2.2	4.5*	12,6				
M 2.5	5	15,1				
M 3	5,5	17,8				
M 3.5	6*	20,6	23,2			
M 4	7	26,8	33,2			
M 5	8	33,6	45,5	94,1		
	9*	41,1	59,9	119,2		
M 6	10	49,1	76,7	147		
M 7	11	57,8	96	178		
	12	67,0	118	212		
M 8	13	68,6	141	249		
	14*	68,6	169	288		
	15		198	331		
	16		225	377		
M 10	17		225	425		
	18		225	477		
M 12	19*		225	531		
	20*		225	569		
	21		225	569	-	
M 14	22*		225	569	569	
	23*			569	569	
M 16	24			569	569	
	25*			569	583	
	26*			569	624	
M 18	27			569	665	
	28*			569	707	
M 20	30			569	795	
M 22	32*			569	888	
	34			569	984	
M 24	36				1084	1677
M 27	41				1353	1910
M 30	46				1569	2143
M 33	50				1569	2329
M 36	55				1569	2562
M 39	60				1569	2795
M 42	65					2795
M 45	70					2795
M 48	75					2795
M 52	80					2795



# SIKMA / TEST TORK DEĞERLERİ TIGHTENING / TEST TORQUE VALUES

Önerilen (Bağlayıcı olmayan) cıvata sıkma torkları Nm (Newton Metre)  
Suggested (Not Compulsory) Bolt Tightening Torque in Nm (Newton Meter)

**Kalite Sınıfı DIN 267'ye Göre Sıkma Değerleri**  
Tightening Torques Values According to Quality Class DIN 267

	<b>4.6</b>	<b>5.6</b>	<b>6.9</b>	<b>8.8</b>	<b>10.9</b>	<b>12.9</b>
<b>M 2</b>	0,123	0,162	0,314	0,373	0,520	0,628
<b>M 2,2</b>	0,196	0,265	0,510	0,598	0,843	1,010
<b>M 2,5</b>	0,284	0,373	0,726	0,863	1,206	1,451
<b>M 3</b>	0,441	0,588	1,128	1,344	1,883	2,256
<b>M 3,5</b>	0,677	0,902	1,736	2,060	2,893	3,481
<b>M 4</b>	1,000	1,344	2,599	3,040	4,315	5,148
<b>M 5</b>	1,916	2,648	5,099	6,031	8,483	10,200
<b>M 6</b>	3,432	4,511	8,728	10,300	14,710	17,652
<b>M 7</b>	5,590	7,453	14,220	17,162	24,517	28,439
<b>M 8</b>	8,238	10,787	21,575	25,497	35,304	42,168
<b>M 10</b>	16,67	21,575	42,168	50,014	70,608	85,317
<b>M 12</b>	28,44	38,246	73,550	87,279	122,60	147,10
<b>M 14</b>	45,11	60,801	116,70	138,30	194,20	235,40
<b>M 16</b>	69,63	93,163	178,5	210,80	299,10	357,90
<b>M 18</b>	95,12	127,50	245,20	289,3	411,90	490,30
<b>M 20</b>	135,3	180,45	384,10	411,90	578,60	696,30
<b>M 22</b>	182,4	245,16	470,70	559,00	784,50	941,40
<b>M 24</b>	230,5	308,91	598,20	711,00	1000	1196
<b>M 27</b>	343,2	460,90	887,50	1049	1481	1775
<b>M 30</b>	465,8	622,72	1206	1422	2010	2403
<b>M 33</b>	632,5	848,30	1628	1932	2716	3266
<b>M 36</b>	814,0	1089	2099	2481	3491	4197
<b>M 39</b>	1059	1412	2716	3226	4531	5443
<b>M 42</b>	1304	1746	3364	3991	5609	6727
<b>M 45</b>	1638	2177	4207	4992	7012	8414
<b>M 48</b>	1981	2638	5080	6021	8473	10150
<b>M 52</b>	2540	3393	6541	7747	10885	13092
<b>M 56</b>	3168	4227	8149	9650	13582	16279
<b>M 60</b>	3932	5247	10101	11964	16867	20202
<b>M 64</b>	4737	6306	12160	14416	20300	24320

**Moment Değerleri Yağlanmış Cıvatalar İçin %20 Azaltılmalıdır.**  
Torque Values Should be Decreased of 20% for Lubricated Screws

## TEKNİK BİLGİLER / TECHNICAL DATA

**Ölçü Birimleri**  
 Measuring Units

Giga	G	1.000.000.000	=10 <sup>9</sup>	1GW= 1 Milyar Watt
Mega	M	1.000.000	=10 <sup>6</sup>	1 MW= 1 Milyon Watt
Kilo	k	1.000	=10 <sup>3</sup>	1 kW= Bin Watt
Milli	m	0.001	=10 <sup>-3</sup>	1 mm= Binde Bir Watt
Mikro	m	0.000001	=10 <sup>-6</sup>	1 mm= 1 Milyonda Bir Watt
Nano	n	0.000000001	=10 <sup>-9</sup>	1 nm= 1 Milyarda Bir Watt

**Önemli Ölçülerin Değişim Tablosu**  
 Conversion Table For Essential Measuring Units

Uzunluk Length	Metre	m		
Kütle Weight	Kilogram	kg		
Zaman Time	Saniye	s		
Kuvvet Force	Newton	N	=kg m/s <sup>2</sup>	1 N= 0.102 kp
Döndürme Mom. Torque	Newtonmetre			9.81 Nm= 1kpm
İş Enerjisi Work	Joule	J	=Nm	
Isı Enerjisi Heat	Joule	J		1 J= 0.239 cal
Güç Power	Watt	W	=Nm/s	1 kW= 1.36 PS=860 kcal/h
Basınç Pressure	Pascal	Pa	=N/m <sup>2</sup>	100.000 Pa=1 bar=10 mWS
Elektrik Akımı Electricity Current	Amper	A		
Sıcaklık Temperature	Kelvin	K		1K= -272.15 °C

**Döndürme Momenti Dönüşüm Tablosu**  
 Conversion Table For Bending Moments

Var Olan Ölçüler/ present units	İstenen Ölçüler / Wanted Units					
	=Ncm	=Nm	=kpcm	=kpm	=lbf.in.	=lbf.ft.
Ncm	1	0.01	0.10197	0.00102	0.0885	0.00738
Nm	100	1	10.197	0.10197	8.851	0.7376
kpcm	9.807	0.09807	1	0.01	0.868	0.0723
kpm	980.07	9.807	100	1	86.796	7.233
lbf.in.	11.298	0.11298	1.152	0.01152	1	0.0833
lbf.ft.	135.58	1.3558	13.825	0.13825	12	1

**Newton-Metre ve Librefoot Dönüşüm Tablosu**  
 Conversion Table Of Newton-Meter And Librefoot  
 (1 Nm=0.738 lbf.ft.)

Nm	ft.,lbs.									
	0	1	2	3	4	5	6	7	8	9
0	0	0.74	1.48	2.21	2.95	3.69	4.43	5.17	5.90	6.64
10	7.38	8.12	8.86	9.59	10.33	11.07	11.81	12.54	13.28	14.02
20	14.76	15.50	16.2	16.97	17.71	18.45	19.19	19.93	20.65	21.40
30	22.14	22.88	23.62	24.35	25.10	25.83	26.57	27.31	28.04	28.78
40	29.52	30.26	31.00	31.73	32.47	33.21	33.95	34.69	35.42	36.16
50	36.90	37.64	38.38	39.11	39.85	40.59	41.33	42.07	42.80	43.54
60	44.28	45.02	45.76	46.49	47.23	47.97	48.71	49.45	50.18	50.92
70	51.66	52.40	53.14	53.87	54.61	55.35	56.09	56.83	57.56	58.30
80	59.04	59.78	60.52	61.25	62.00	62.73	63.47	64.21	64.94	65.68
90	66.42	67.16	67.90	68.63	69.37	70.11	70.85	71.59	72.32	73.06
100	73.80	74.54	75.28	76.01	76.75	77.49	78.23	78.97	79.70	80.44

**Librefoot ve Newton-Metre Dönüşüm Tablosu**  
 Conversion Table Of Librefoot And Newton-Meter  
 (1 lbf.ft.=1.356 Nm)

ft.-lbs.	Nm									
	0	1	2	3	4	5	6	7	8	9
0	0	1.36	2.71	4.07	5.42	6.78	8.14	9.49	10.85	12.20
10	13.56	14.92	16.27	17.63	18.98	20.34	21.70	23.05	24.41	25.76
20	27.12	28.48	29.83	31.19	32.54	33.90	35.26	36.61	37.97	39.32
30	40.68	42.04	43.39	44.75	46.10	47.46	48.82	50.17	51.53	52.88
40	54.24	55.60	56.95	58.31	59.66	61.02	62.38	63.73	65.09	66.44
50	67.80	69.16	70.51	71.87	73.22	74.58	75.94	77.29	78.65	80.00
60	81.36	82.72	84.07	85.43	86.78	88.14	89.50	90.85	92.21	93.56
70	94.92	96.28	97.63	98.99	100.34	101.70	103.06	104.41	105.77	107.12
80	108.48	109.84	111.19	112.55	113.90	115.26	116.62	117.97	119.33	120.68
90	122.04	123.40	124.75	126.11	127.46	128.82	130.18	131.53	132.89	134.24
100	135.60	136.96	138.31	139.67	141.02	142.38	143.74	145.09	146.45	147.80

**Newton-Metre ve Kilopound-Metre Dönüşüm Tablosu**  
 Conversion Table Of Newton-Meter and Kilopound-Meter  
 (1 Nm=0.102 kpm)

Nm	kpm									
	0	1	2	3	4	5	6	7	8	9
0	0.00	1.02	2.04	3.06	4.08	5.10	6.12	7.14	8.16	9.18
100	10.20	11.22	12.24	13.26	14.28	15.30	16.31	17.33	18.35	19.37
200	20.39	21.41	22.43	23.45	24.47	25.49	26.51	27.53	28.55	29.57
300	30.59	31.61	32.63	33.65	34.67	35.69	36.71	37.73	38.75	39.77
400	40.79	41.81	42.83	43.85	44.87	45.89	46.91	47.93	48.95	49.97
500	50.99	52.00	53.02	54.04	55.06	56.08	57.10	58.12	59.14	60.16
600	61.18	62.20	63.22	64.24	65.26	66.28	67.30	68.32	69.34	70.36
700	71.38	72.40	73.42	74.44	75.46	76.48	77.50	78.52	79.54	80.56
800	81.58	82.60	83.62	84.64	85.66	86.68	87.70	88.71	89.73	90.75
900	91.77	92.79	93.81	94.83	95.85	96.87	97.89	98.91	99.93	100.95
1000	101.97	102.99	104.01	105.03	106.05	107.07	108.09	109.11	110.13	111.15



**Sertlik Dönüşüm Tablosu**  
*Hardness Conversion Table*

Vickers Sertlik Hardness	Brinell Sertlik Hardness	Rockwell Sertlik Hardness		Çekme dayanımı Tensile Strength
HV 30	HB 30	HRB	HRC	sB N/mm2
80	80.7	36.4	-	270
85	85	42.4	-	290
90	90	47.4	-	310
95	95	52.00	-	320
100	100	56.4	-	340
105	105	60.0	-	360
110	110	63.4	-	380
115	115	66.4	-	390
120	120	69.4	-	410
125	125	72.0	-	420
130	130	74.4	-	440
135	135	76.4	-	460
140	140	78.4	-	470
145	145	80.4	-	490
150	150	82.2	-	500
155	155	83.8	-	520
160	160	85.4	-	540
165	165	86.8	-	550
170	170	88.2	-	570
175	175	89.6	-	590
180	180	90.8	-	600
185	185	91.8	-	620
195	190	91.5	-	640
200	195	94.0	-	660
200	200	95.0	-	670
205	205	95.8	-	680
210	210	96.6	-	710
215	215	97.4	-	720
220	220	98.2	-	730
225	225	99.0	-	750
230	230	-	19.2	760
235	235	-	20.2	780
240	240	-	21.2	800
245	245	-	22.1	820
250	250	-	23.0	830
255	255	-	23.8	850
260	260	-	24.6	870
265	265	-	25.4	880
280	280	-	27.1	900
275	275	-	26.9	920
280	280	-	27.6	940
285	285	-	28.3	950
290	290	-	29.0	970
295	295	-	29.6	990
300	300	-	30.3	1010
310	310	-	31.5	1040
320	320	-	32.7	1080
330	330	-	33.8	1110

Vickers Sertlik Hardness	Brinell Sertlik Hardness	Rockwell Sertlik Hardness		Çekme dayanımı Tensile Strength
HV 30	HB 30	HRB	HRC	sB N/mm2
340	340	-	34.9	1140
350	350	-	36.0	1170
360	359	-	37.0	1200
370	368	-	38.0	1260
380	376	-	38.9	1260
390	385	-	39.8	1290
400	392	-	40.7	1320
410	400	-	41.5	1350
420	408	-	42.4	1380
440	423	-	44.0	1430
450	430	-	44.8	1460
460	-	-	45.6	-
470	-	-	46.3	-
480	-	-	47.0	-
490	-	-	47.7	-
500	-	-	48.3	-
510	-	-	49.1	-
520	-	-	49.7	-
530	-	-	50.4	-
540	-	-	51.0	-
550	-	-	51.6	-
560	-	-	52.2	-
570	-	-	52.8	-
580	-	-	53.3	-
590	-	-	53.9	-
600	-	-	54.4	-
610	-	-	55.0	-
620	-	-	55.5	-
630	-	-	56.0	-
640	-	-	56.5	-
650	-	-	57.0	-
660	-	-	57.5	-
670	-	-	58.0	-
680	-	-	58.5	-
690	-	-	59.0	-
700	-	-	59.5	-
720	-	-	60.4	-
740	-	-	61.2	-
760	-	-	62.0	-
780	-	-	62.8	-
800	-	-	63.6	-
820	-	-	64.3	-
840	-	-	65.0	-
860	-	-	65.7	-
880	-	-	66.3	-
900	-	-	66.9	-
920	-	-	67.5	-
940	-	-	68.0	-



## Semboller / Symbols

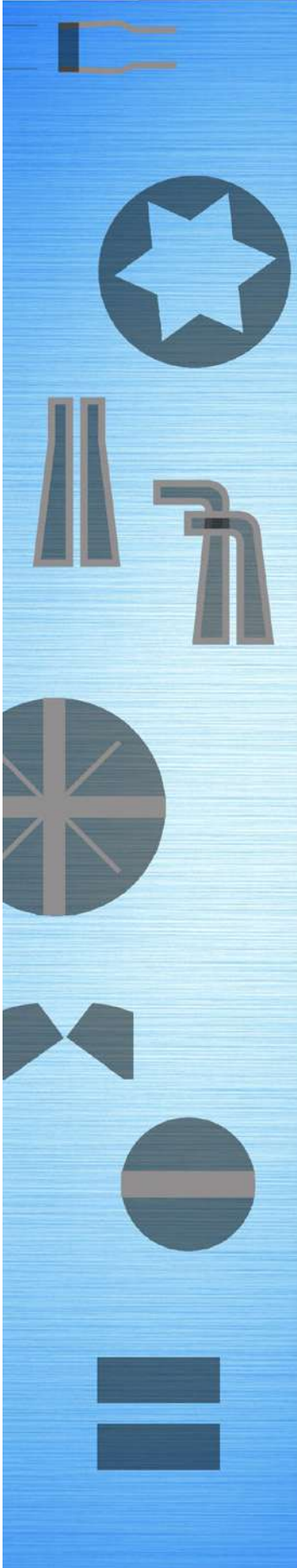

Anahtar Ağız  
Size



Ağız Açıklığı  
Opening Limit of Jaws



Altı Köşe Lokma Bijon  
Anahtar Ağız  
Six Point Sockets



Sekiz Köşe Anahtar Ağız  
Eight Point Wrench



On iki Köşe Anahtar Ağız  
Twelve Point Wrench



Kare Adaptör  
Square Adapter



Kovan Anahtar  
Tubular Socket Wrench



Bir Ağız Bijon Anahtar  
Single Ended Rim Wrench



TORX® Lokma Anahtar  
TORX Socket



Düz Uç  
Flat Tip



Yıldız Uç  
PHILLIPS® Tip



POZIDRIV® Yıldız Uç  
POZIDRIV® Tip



TORX® Uç  
TORX® Tip



Delikli TORX® Uç  
TORX® with hole



Bits Tutucular  
Bit Holders



Allen Anahtar  
Hexagonal Allen Keys



Segman  
Circlip



Gövde Ağırlık  
Weight of Body



Tapa Anahtar  
Wrench for Carter Case



İşkençe  
Screw Clamp



Çektirme  
Puller



in.	dec.in.	0"	1"	2"	3"	4"	5"	6"	7"	8"	9"	10"	11"
millimeters (mm)													
0	0	0	25.400 0	50.800 0	76.200 0	101.600 0	127.000 0	152.400 0	177.800 0	203.200 0	228.600 0	254.000 0	279.400 0
1/64	0.015 625	0.396 9	25.796 9	51.196 9	76.596 9	101.996 9	127.396 9	152.796 9	178.196 9	203.596 9	228.996 9	254.396 9	279.796 9
1/32	0.031 25	0.793 8	26.193 8	51.593 8	76.993 8	102.393 8	127.793 8	153.193 8	178.593 8	203.993 8	229.393 8	254.793 8	280.193 8
3/64	0.046 875	1.190 6	26.590 6	51.990 6	77.390 6	102.790 6	128.190 6	153.590 6	178.990 6	204.390 6	229.790 6	255.190 6	280.590 6
1/16	0.062 5	1.587 5	26.987 5	52.387 5	77.787 5	103.187 5	128.587 5	153.987 5	179.387 5	204.787 5	230.187 5	255.587 5	280.987 5
5/64	0.078 125	1.984 4	27.384 4	52.784 4	78.184 4	103.584 4	128.984 4	154.384 4	179.784 4	205.184 4	230.584 4	255.984 4	281.384 4
3/32	0.093 75	2.381 2	27.781 2	53.181 2	78.581 2	103.981 2	129.381 2	154.781 2	180.181 2	205.581 2	230.981 2	256.381 2	281.781 2
7/64	0.109 375	2.778 1	28.178 1	53.578 1	78.978 1	104.378 1	129.778 1	155.178 1	180.578 1	205.978 1	231.378 1	256.778 1	282.178 1
1/8	0.125	3.175 0	28.575 0	53.975 0	79.375 0	104.775 0	130.175 0	155.575 0	180.975 0	206.375 0	231.775 0	257.175 0	282.575 0
9/64	0.140 625	3.571 9	28.971 9	54.371 9	79.771 9	105.171 9	130.571 9	155.971 9	181.371 9	206.771 9	232.171 9	257.571 9	282.971 9
5/32	0.156 25	3.968 8	29.368 8	54.768 8	80.168 8	105.568 8	130.968 8	156.368 8	181.768 8	207.168 8	232.568 8	257.968 8	283.368 8
11/64	0.171 875	4.365 6	29.765 6	55.165 6	80.565 6	105.965 6	131.365 6	156.765 6	182.165 6	207.565 6	232.965 6	258.365 6	283.765 6
3/16	0.187 5	4.762 5	30.162 5	55.562 5	80.962 5	106.362 5	131.762 5	157.162 5	182.562 5	207.962 5	233.362 5	258.762 5	284.162 5
13/64	0.203 125	5.159 4	30.559 4	55.959 4	81.359 4	106.759 4	132.159 4	157.559 4	182.959 4	208.359 4	233.759 4	259.159 4	284.559 4
7/32	0.218 75	5.556 2	30.956 2	56.356 2	81.756 2	107.156 2	132.556 2	157.956 2	183.356 2	208.756 2	234.156 2	259.556 2	284.956 2
15/64	0.234 375	5.953 1	31.353 1	56.753 1	82.153 1	107.553 1	132.953 1	158.353 1	183.753 1	209.153 1	234.553 1	259.953 1	285.353 1
1/4	0.25	6.350 0	31.750 0	57.150 0	82.550 0	107.950 0	133.350 0	158.750 0	184.150 0	209.550 0	234.950 0	260.350 0	285.750 0
17/64	0.265 625	6.746 9	32.146 9	57.546 9	82.946 9	108.346 9	133.746 9	159.146 9	184.546 9	209.946 9	235.346 9	260.746 9	286.146 9
9/32	0.281 25	7.143 8	32.543 8	57.943 8	83.343 8	108.743 8	134.143 8	159.543 8	184.943 8	210.343 8	235.743 8	261.143 8	286.543 8
19/64	0.296 875	7.540 6	32.940 6	58.340 6	83.740 6	109.140 6	134.540 6	159.940 6	185.340 6	210.740 6	236.140 6	261.540 6	286.940 6
5/16	0.312 5	7.937 5	33.337 5	58.737 5	84.137 5	109.537 5	134.937 5	160.337 5	185.737 5	211.137 5	236.537 5	261.937 5	287.337 5
21/64	0.328 125	8.334 4	33.734 4	59.134 4	84.534 4	109.934 4	135.334 4	160.734 4	186.134 4	211.534 4	236.934 4	262.334 4	287.734 4
11/32	0.343 75	8.731 2	34.131 2	59.531 2	84.931 2	110.331 2	135.731 2	161.131 2	186.531 2	211.931 2	237.331 2	262.731 2	288.131 2
23/64	0.359 375	9.128 1	34.528 1	59.928 1	85.328 1	110.728 1	136.128 1	161.528 1	186.928 1	212.328 1	237.728 1	263.128 1	288.528 1
3/8	0.375	9.525 0	34.925 0	60.325 0	85.725 0	111.125 0	136.525 0	161.925 0	187.325 0	212.725 0	238.125 0	263.525 0	288.925 0
25/64	0.390 625	9.921 9	35.321 9	60.721 9	86.121 9	111.521 9	136.921 9	162.321 9	187.721 9	213.121 9	238.521 9	263.921 9	289.321 9
13/32	0.406 25	10.318 8	35.718 8	61.118 8	86.518 8	111.918 8	137.318 8	162.718 8	188.118 8	213.518 8	238.918 8	264.318 8	289.718 8
27/64	0.421 875	10.715 6	36.115 6	61.515 6	86.915 6	112.315 6	137.715 6	163.115 6	188.515 6	213.915 6	239.315 6	264.715 6	290.115 6
7/16	0.437 5	11.112 5	36.512 5	61.912 5	87.312 5	112.712 5	138.112 5	163.512 5	188.912 5	214.312 5	239.712 5	265.112 5	290.512 5
29/64	0.453 125	11.509 4	36.909 4	62.309 4	87.709 4	113.109 4	138.509 4	163.909 4	189.309 4	214.709 4	240.109 4	265.509 4	290.909 4
15/32	0.468 75	11.906 2	37.306 2	62.706 2	88.106 2	113.506 2	138.906 2	164.306 2	189.706 2	215.106 2	240.506 2	265.906 2	291.306 2
31/64	0.484 375	12.303 1	37.703 1	63.103 1	88.503 1	113.903 1	139.303 1	164.703 1	190.103 1	215.503 1	240.903 1	266.303 1	291.703 1
1/2	0.5	12.700 0	38.100 0	63.500 0	88.900 0	114.300 0	139.700 0	165.100 0	190.500 0	215.900 0	241.300 0	266.700 0	292.100 0
33/64	0.515 625	13.096 9	38.496 9	63.896 9	89.296 9	114.696 9	140.096 9	165.496 9	190.896 9	216.296 9	241.696 9	267.096 9	292.496 9
17/32	0.531 25	13.493 8	38.893 8	64.293 8	89.693 8	115.093 8	140.493 8	165.893 8	191.293 8	216.693 8	242.093 8	267.493 8	292.893 8
35/64	0.546 875	13.890 6	39.290 6	64.690 6	90.090 6	115.490 6	140.890 6	166.290 6	191.690 6	217.090 6	242.490 6	267.890 6	293.290 6
9/16	0.562 5	14.287 5	39.687 5	65.087 5	90.487 5	115.887 5	141.287 5	166.687 5	192.087 5	217.487 5	242.887 5	268.287 5	293.687 5
37/64	0.578 125	14.684 4	40.084 4	65.484 4	90.884 4	116.284 4	141.684 4	167.084 4	192.484 4	217.884 4	243.284 4	268.684 4	294.084 4
19/32	0.593 75	15.081 2	40.481 2	65.881 2	91.281 2	116.681 2	142.081 2	167.481 2	192.881 2	218.281 2	243.681 2	269.081 2	294.481 2
39/64	0.609 375	15.478 1	40.878 1	66.278 1	91.678 1	117.078 1	142.478 1	167.878 1	193.278 1	218.678 1	244.078 1	269.478 1	294.878 1
5/8	0.625	15.875 0	41.275 0	66.675 0	92.075 0	117.475 0	142.875 0	168.275 0	193.675 0	219.075 0	244.475 0	269.875 0	295.275 0
41/64	0.640 625	16.271 9	41.671 9	67.071 9	92.471 9	117.871 9	143.271 9	168.671 9	194.071 9	219.471 9	244.871 9	270.271 9	295.671 9
21/32	0.656 25	16.668 8	42.068 8	67.468 8	92.868 8	118.268 8	143.668 8	169.068 8	194.468 8	219.868 8	245.268 8	270.668 8	296.068 8
43/64	0.671 875	17.065 6	42.465 6	67.865 6	93.265 6	118.665 6	144.065 6	169.465 6	194.865 6	220.265 6	245.665 6	271.065 6	296.465 6
11/16	0.687 5	17.462 5	42.862 5	68.262 5	93.662 5	119.062 5	144.462 5	169.862 5	195.262 5	220.662 5	246.062 5	271.462 5	296.862 5
45/64	0.703 125	17.859 4	43.259 4	68.659 4	94.059 4	119.459 4	144.859 4	170.259 4	195.659 4	221.062 5	246.459 4	271.859 4	297.259 4
23/32	0.718 75	18.256 2	43.656 2	69.056 2	94.456 2	119.856 2	145.256 2	170.656 2	196.056 2	221.456 2	246.856 2	272.256 2	297.656 2
47/64	0.734 375	18.653 1	44.053 1	69.453 1	94.853 1	120.253 1	145.653 1	171.053 1	196.453 1	221.853 1	247.253 1	272.653 1	298.053 1
3/4	0.75	19.050 0	44.450 0	69.850 0	95.250 0	120.650 0	146.050 0	171.450 0	196.850 0	222.250 0	247.650 0	273.050 0	298.450 0
49/64	0.765 625	19.446 9	44.846 9	70.246 9	95.646 9	121.046 9	146.446 9	171.846 9	197.246 9	222.646 9	248.046 9	273.446 9	298.846 9
25/32	0.781 25	19.843 8	45.243 8	70.643 8	96.043 8	121.443 8	146.843 8	172.243 8	197.643 8	223.043 8	248.443 8	273.843 8	299.243 8
51/64	0.796 875	20.240 6	45.640 6	71.040 6	96.440 6	121.840 6	147.240 6	172.640 6	198.040 6	223.440 6	248.840 6	274.240 6	299.640 6
13/16	0.812 5	20.637 5	46.037 5	71.437 5	96.837 5	122.237 5	147.637 5	173.037 5	198.437 5	223.837 5	249.237 5	274.637 5	300.037 5
53/64	0.828 125	21.034 4	46.434 4	71.834 4	97.234 4	122.634 4	148.034 4	173.434 4	198.834 4	224.234 4	249.634 4	275.034 4	300.434 4
27/32	0.843 75	21.431 2	46.831 2	72.231 2	97.631 2	123.031 2	148.431 2	173.831 2	199.231 2	224.631 2	250.031 2	275.431 2	300.831 2
55/64	0.859 375	21.828 1	47.228 1	72.628 1	98.028 1	123.428 1	148.828 1	174.228 1	199.628 1	225.028 1	250.428 1	275.828 1	301.228 1
7/8	0.875	22.225 0	47.625 0	73.025 0	98.425 0	123.825 0	149.225 0	174.625 0	200.025 0	225.425 0	250.825 0	276.225 0	301.625 0
57/64	0.890 625	22.621 9	48.021 9	73.421 9	98.821 9	124.221 9	149.621 9	175.021 9	200.421 9	225.821 9	251.221 9	276.621 9	302.021 9
29/32	0.906 25	23.											

**KALİTE GÜVENCE TESTLERİ / QUALITY ASSURANCE TEST**





## YASAL UYARILAR / LEGAL NOTICE

Bu katalog, önceki baskıların yerine geçer. Katalog içerisinde yer alan ürünlerin teknik özellikleri, görünümü, ölçüleri katalogun yayınlandığı tarihteki mevcut şartları temsil etmektedir. Bu sebeple sipariş verilmeden önce mutlaka firma ile iletişime geçerek sipariş tarihindeki ürünlere ilişkin güncel bilgileri öğrenmenizi öneririz. Katalogta belirtilen ürünlere ait teknik özellikler, görünüm veya ölçü gibi özelliklerin sipariş tarihindeki ürünler ile aynı olmamasından kaynaklı firmanın her ne nam altında olursa olsun hiçbir sorumluluğu bulunmamaktadır. Bu bilgiler doğrultusunda, firma işbu katalog içeriğinde yer alan bilgilerden veya görsel malzemeden kaynaklanabilecek hatalardan, maddi veya manevi zararlardan hiç bir şekil ve surette sorumlu değildir.

Firma katalog içeriğinde yer alan bilgiler veya ürünler ile ilgili önceden haber vermeksizin tek taraflı değişiklikler yapabilir. Firma dilediği zaman, ürünlerinin teknik özelliklerini, görsellerini veya ölçülerini veya ürünlerini tamamen veya kısmen değiştirme hakkına sahiptir. Kataloglarda yer alan görsellerde gözükken montaj, bağlantı detayları, kullanım alanları veya güvenlik önlemleri ürünlerin doğru kullanımı için bir örnek teşkil etmez. Ürünleri kullanan kişiler, katalog içeriğinde yer alan ürünler ile ilgili güvenlik uyarılarına ve ayrıca ürünlere ilişkin ek güvenlik/kullanım talimatlarına uymakla yükümlüdür, aksi takdirde ortaya çıkacak zararlardan firma hiçbir suretle sorumlu tutulamaz.

İşbu Katalog, tüm sayfaları, içeriğindeki bilgiler ve ürünler firmanın fikri ve sınai hakları kapsamında korunmaktadır. Ürün katalogu, içeriğindeki tüm bilgiler ile görseller ve ürünlere ilişkin telif hakkı İzeltaş İzmir El Aletleri Sanayi ve Ticaret A.Ş.'ye aittir. Firmanın yazılı izni olmadan işbu telif hakkına konu ürünlerin, bilgilerin, görsellerin veya katalogun izinsiz kullanılması, yayımlanması, üretilmesi, dağıtılması ve çoğaltılması yasaktır, aksi durum firmanın fikri ve sınai hakkın ihlali sonucunu doğuracaktır.

*This catalog replaces previous editions.*

*The technical features, appearance and dimensions of the products in the catalog represent the current conditions at the date of publication of the catalog. For this reason, we recommend that you contact the company before ordering and learn the current information about the products on the order date. The company does not have any responsibility under any name due to the fact that the technical features, appearance or size of the products specified in the catalog are not the same as the products on the order date. In line with this information, the company is not responsible in any way or form for any errors, material or moral damages that may arise from the information or visual material contained in this catalogue.*

*The company may make unilateral changes regarding the information or products in the catalog without prior notice. The company reserves the right to change the technical specifications, images or dimensions of its products or products, in whole or in part, at any time. The assembly, connection details, usage areas or safety measures seen in the images in the catalogs do not constitute an example for the correct use of the products. Persons using the products are obliged to comply with the safety warnings regarding the products in the catalog content, as well as the additional safety / usage instructions regarding the products, otherwise the company cannot be held responsible for any damages that may arise.*

*This Catalog, all its pages, the information and products in it are protected within the scope of the intellectual and industrial rights of the company. The copyright of the product catalog, all the information in its content, images and products belongs to İzeltaş İzmir El Aletleri Sanayi ve Ticaret A.Ş. Unauthorized use, publication, production, distribution and reproduction of the products, information, images or catalog subject to this copyright without the written permission of the company is prohibited, otherwise it will result in violation of the intellectual and industrial rights of the company.*

### İŞIKKENT FABRİKASI



60.000 m<sup>2</sup> Toplam, 25.000 m<sup>2</sup> Kapalı Alan

### SÜTÇÜLER FABRİKASI



40.000 m<sup>2</sup> Toplam, 15.000 m<sup>2</sup> Kapalı Alan

### TURGUTLU FABRİKASI



40.000 m<sup>2</sup> Toplam, 25.000 m<sup>2</sup> Kapalı Alan

 **IZELTAS®**

**2026 OCAK**



**İzeltaş İzmir El Aletleri Sanayi ve Ticaret A.Ş.**  
Kemalpaşa Cad. No: 303 Işıkkent / İzmir / TÜRKİYE

**Sipariş Telefon / Phone for Orders**

DT : +90 232 472 13 92

T : +90 232 472 13 75

F : +90 232 472 13 78

**Adana Bölge Müdürlüğü / Adana Office**

+90 533 495 53 09

**Ankara Bölge Müdürlüğü / Ankara Office**

+90 533 603 47 29

**İstanbul Bölge Müdürlüğü / Istanbul Office**

+90 535 461 54 87, +90 533 679 02 27

 izeltas\_

 /izeltaselaletleri

 İZELTAŞ

 izeltas A.S.

[www.izeltas.com.tr](http://www.izeltas.com.tr)